

SIZE	1.2ft x 0.7ft x 0.5ft	PIECES	129
DESIGNER	Charles Sharman	MADE IN	U.S.A.

# MOUNTAIN BIKE

⚠ WARNING: Small parts. Age 12+. Handle responsibly. U.S. Patent 9,086,087.



Wrong  
Connecting/Disconnecting Two Directions



Right  
Connecting/Disconnecting One Direction

1

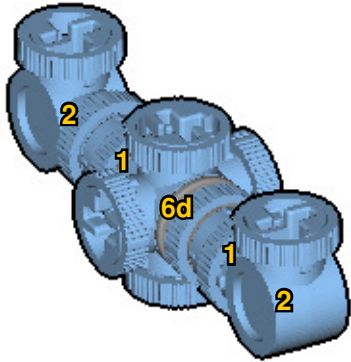

New pieces are drawn blue. Old pieces are drawn white.  
See back for piece names.

2

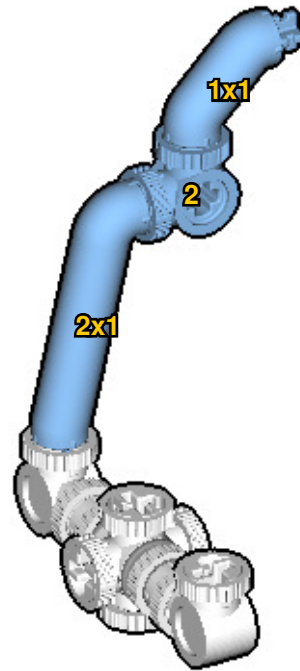

Connect new pieces together before connecting to old pieces.

3

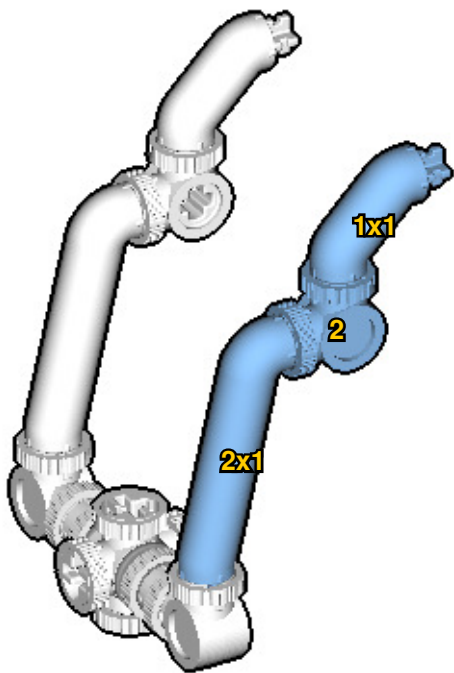

4

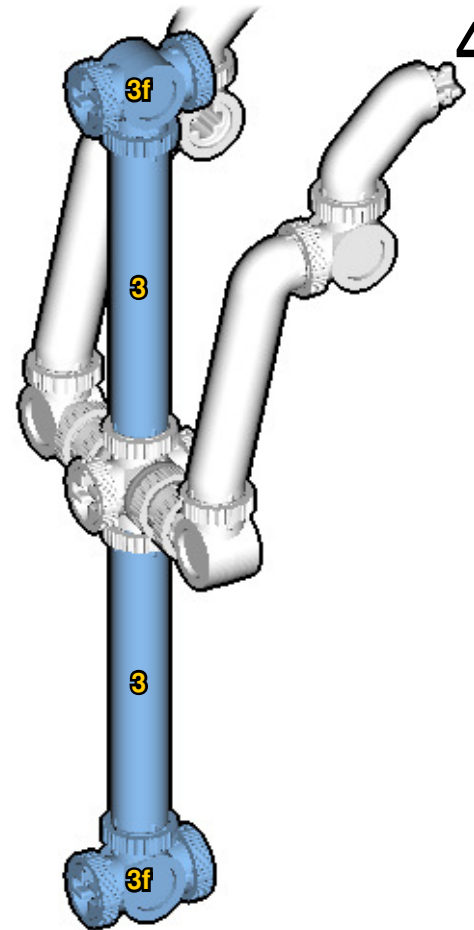

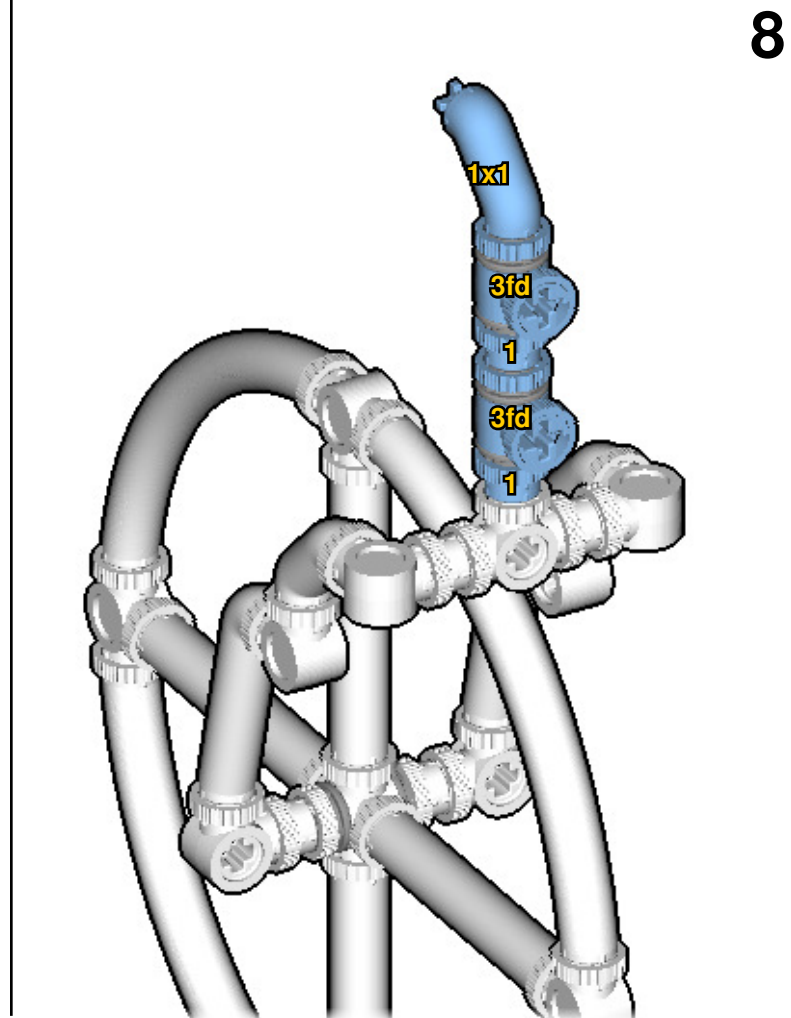
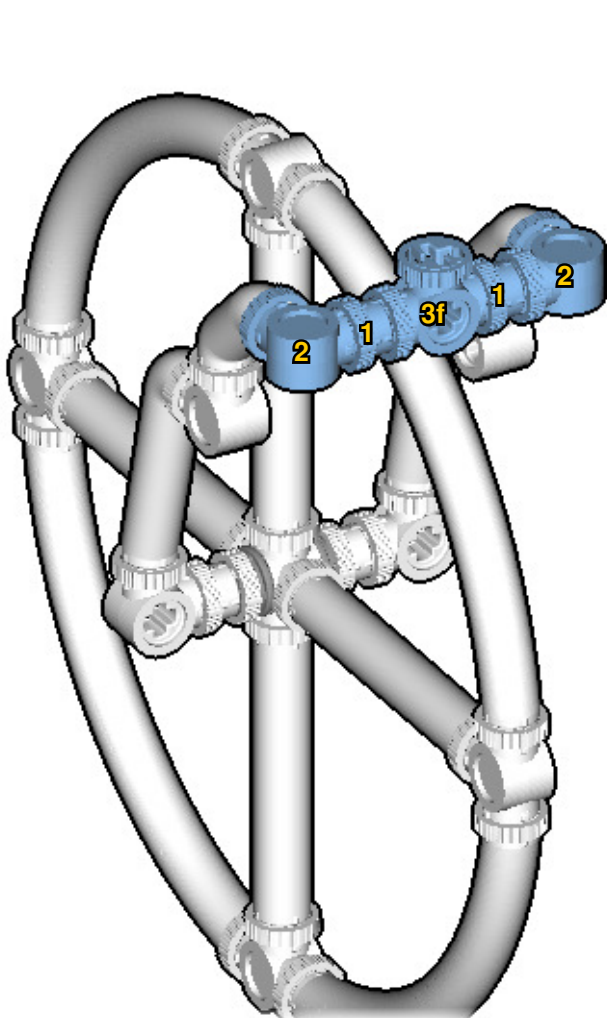
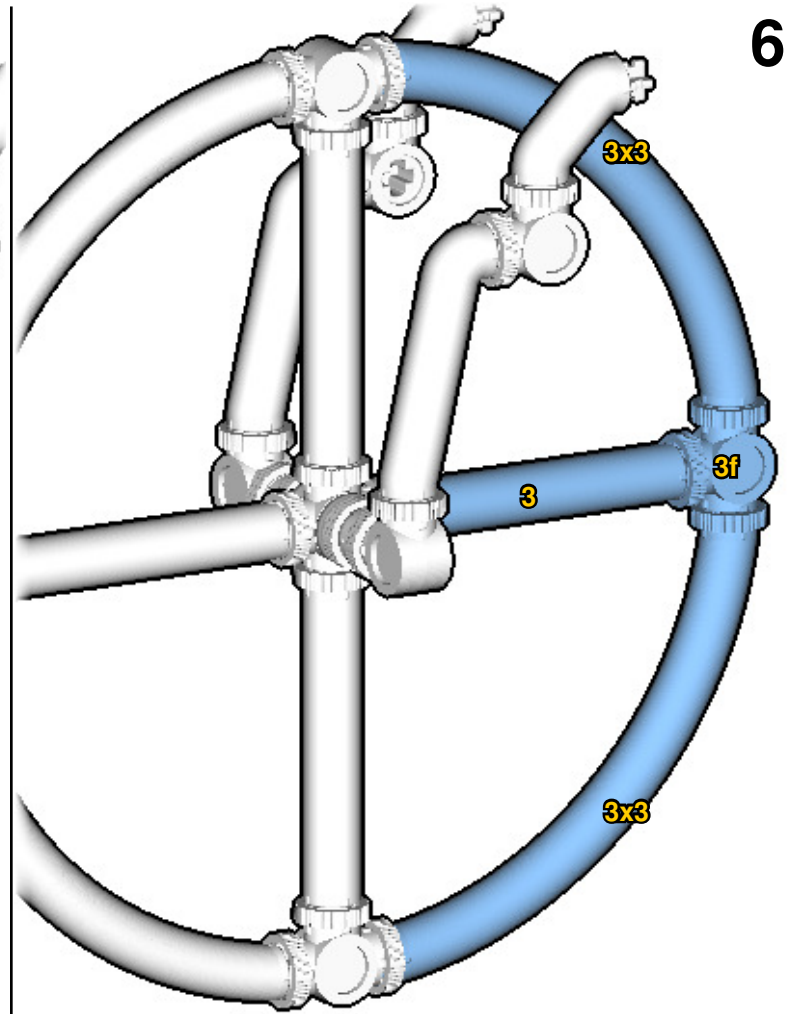
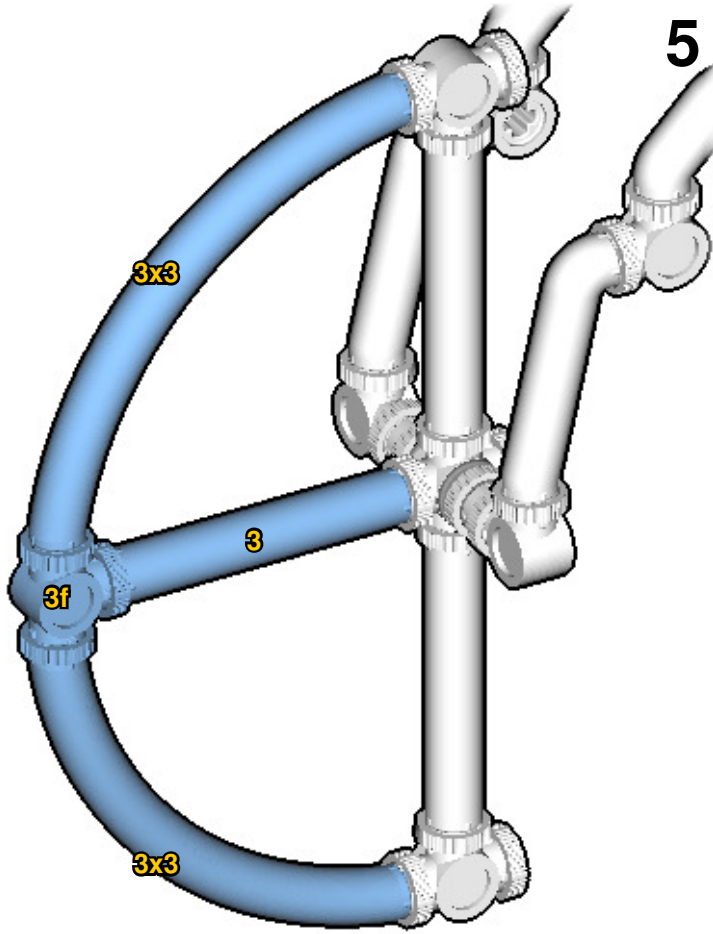

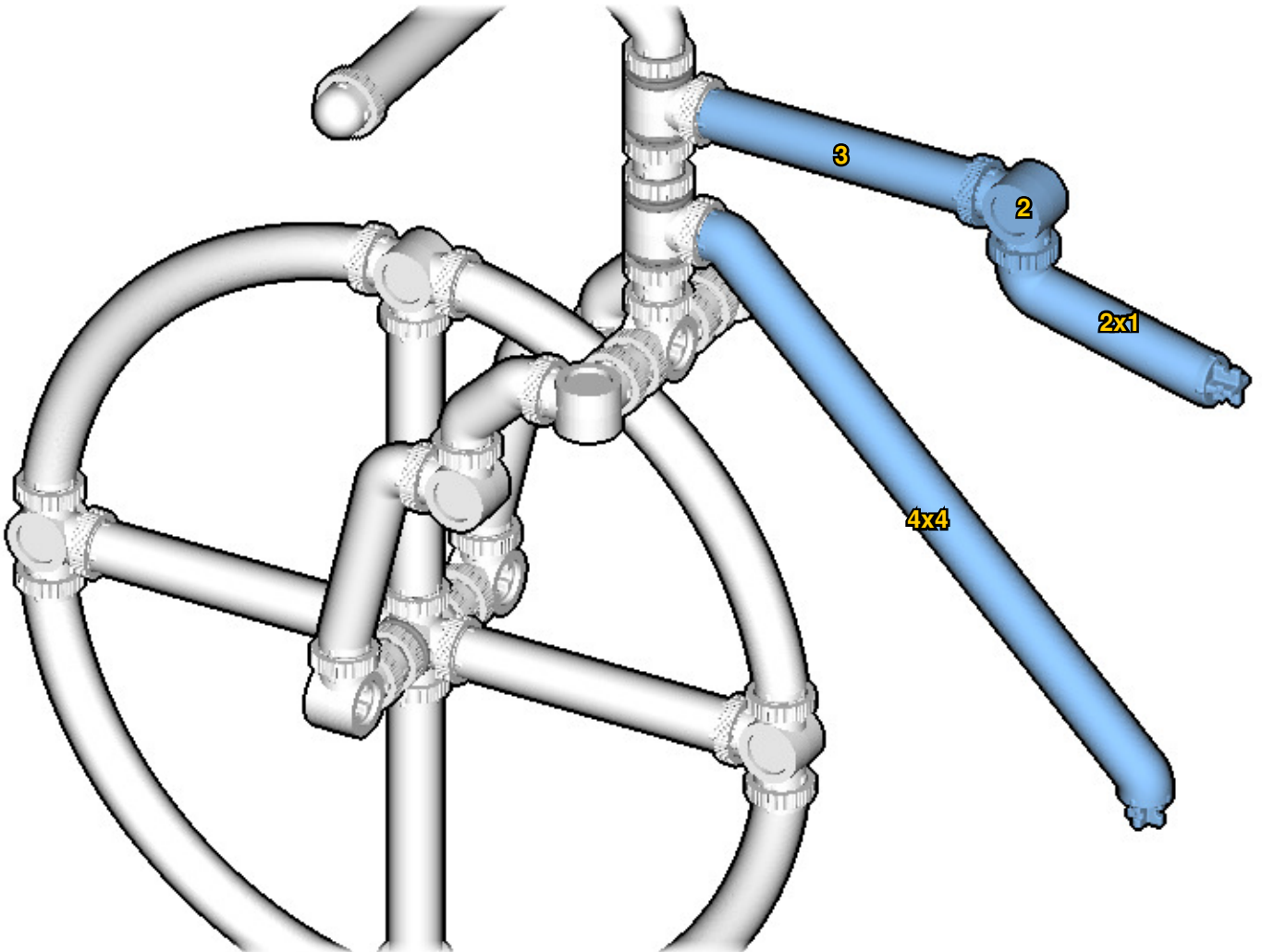
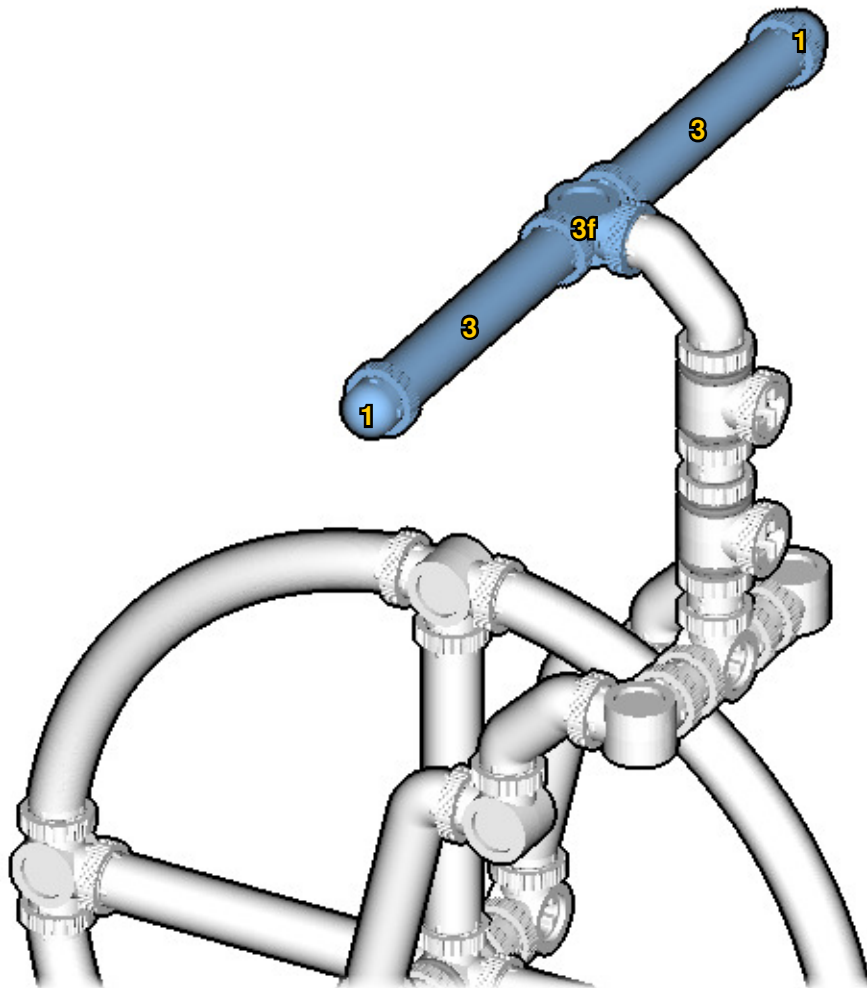

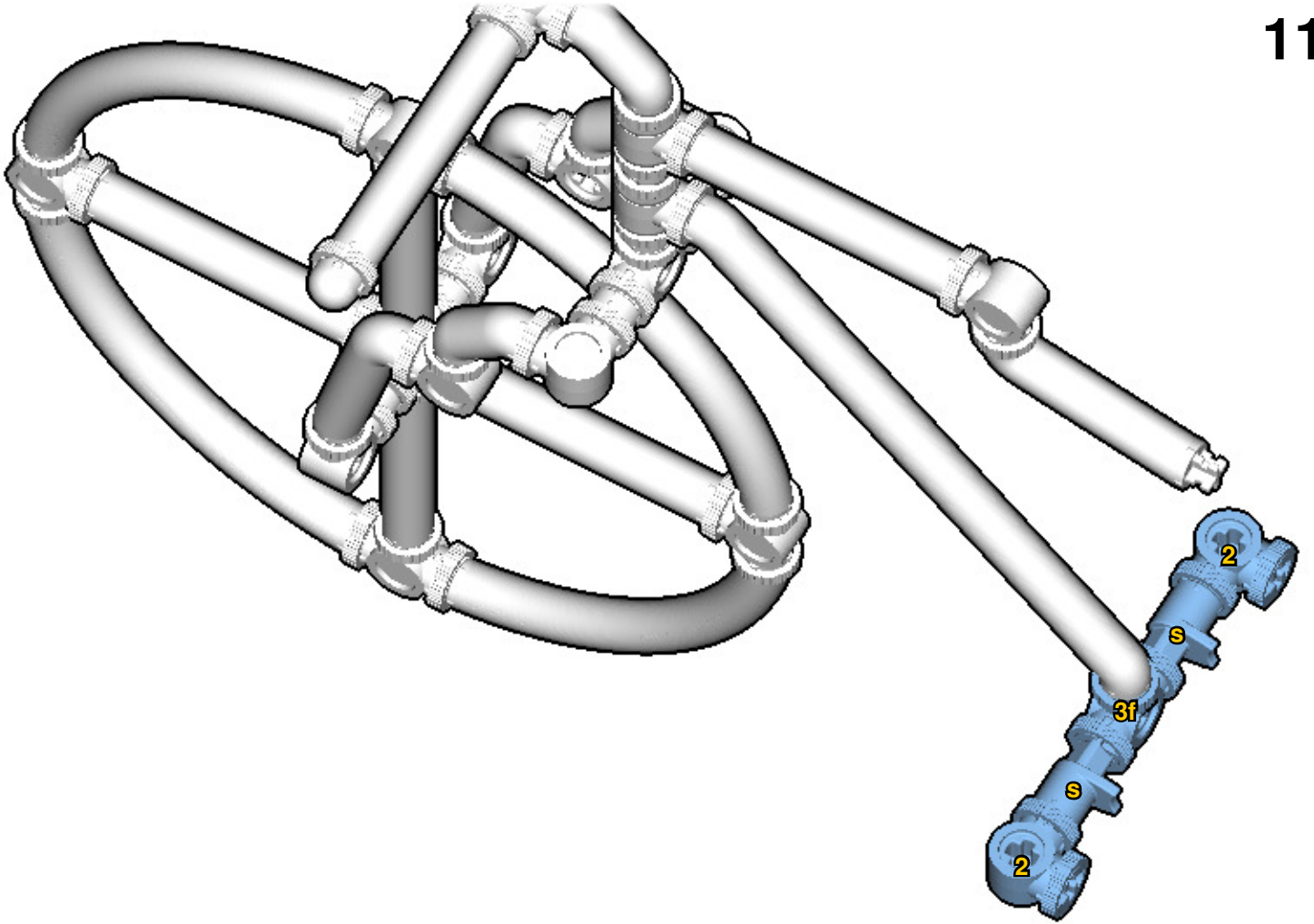

Submodel begins → **12**

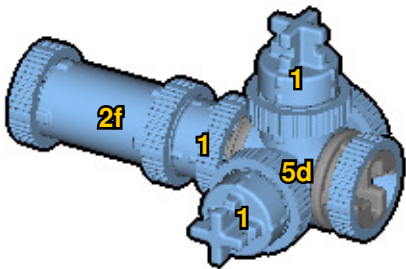

**axle\_g2 gear1**

Slide axle\_g2 through gear1 and join. Make hub face joint.

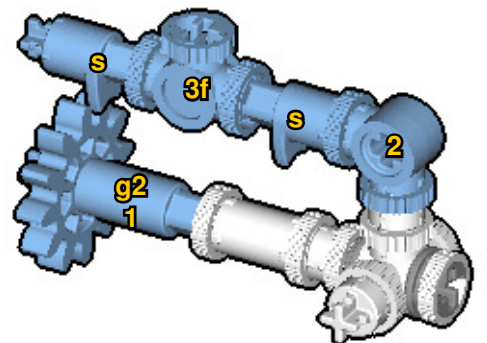

**14**

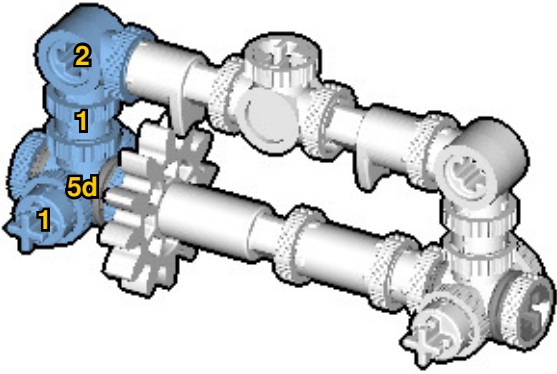

**15**

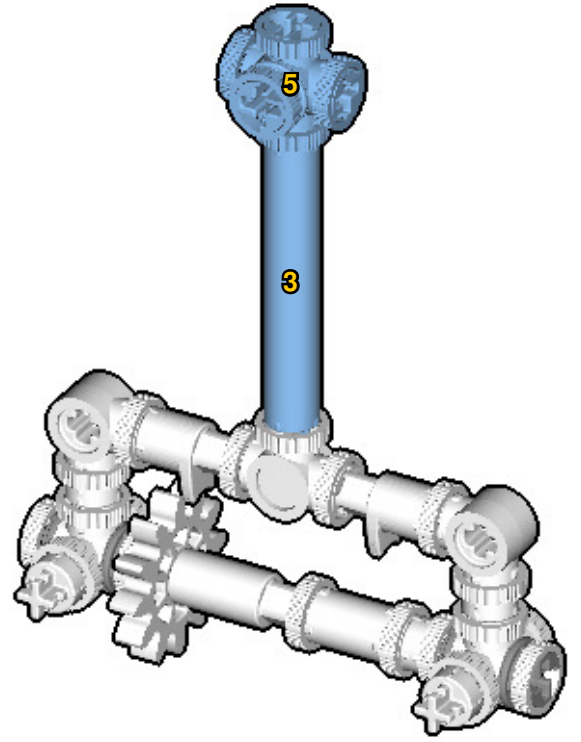

**16**

Submodel ends →

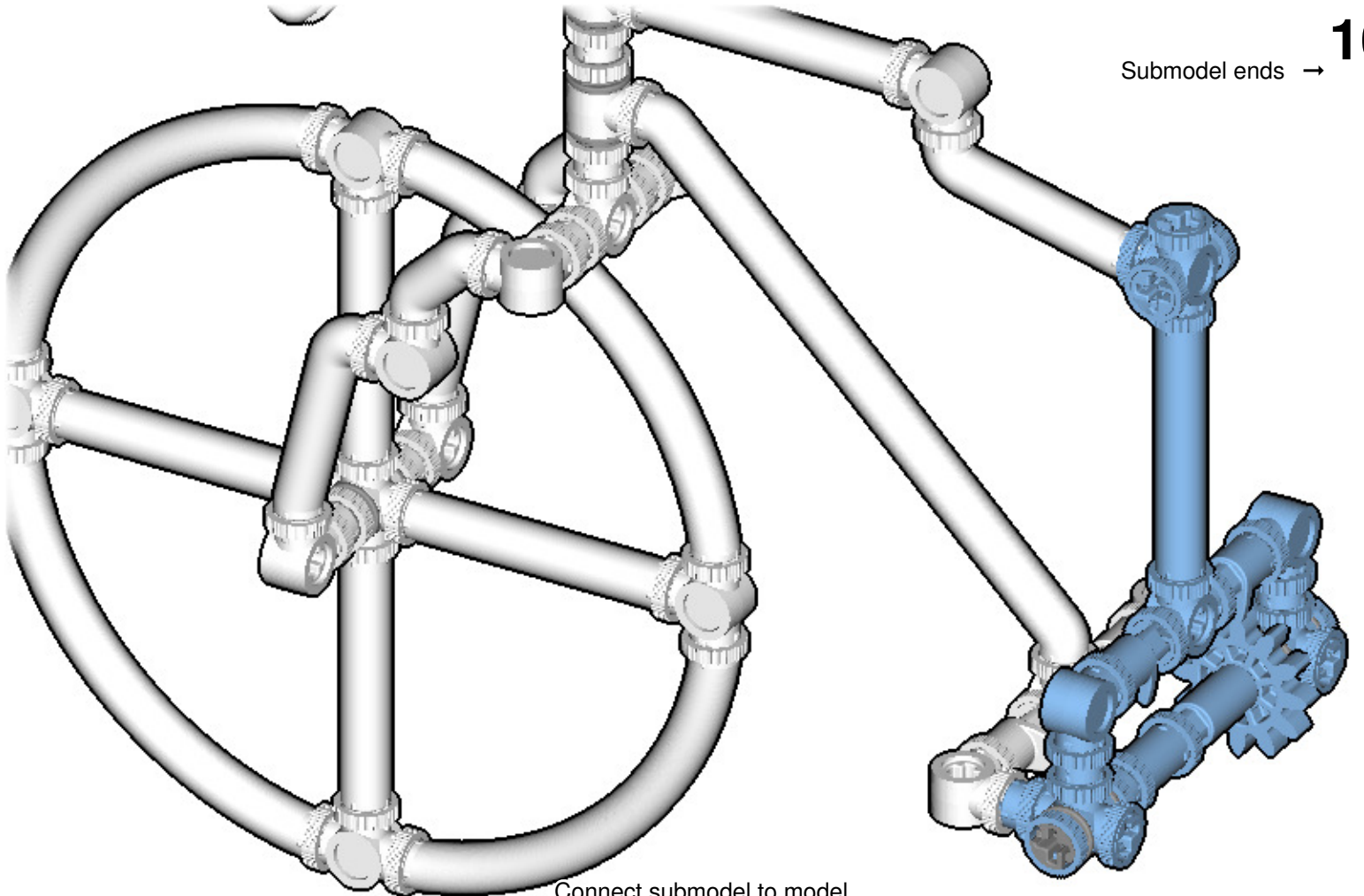

Connect submodel to model.

17

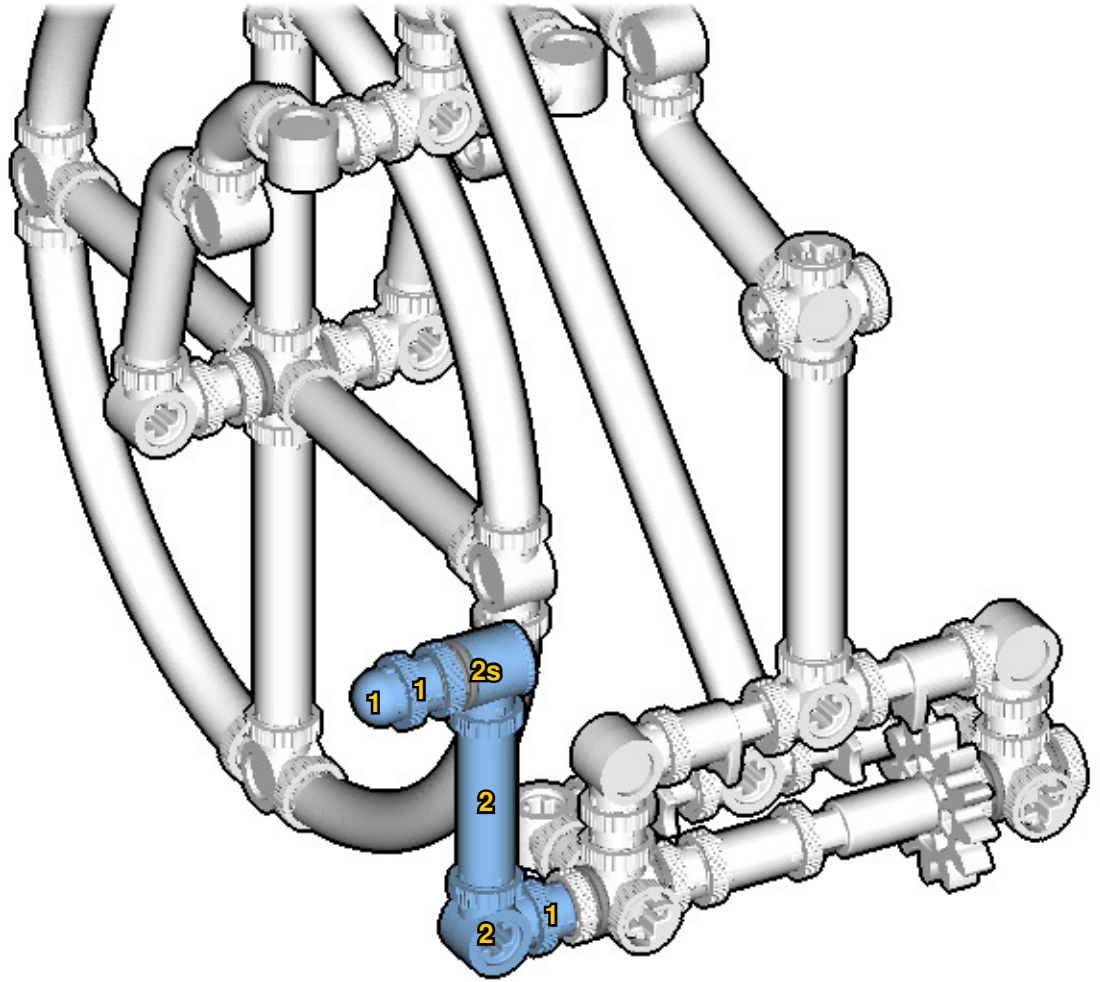

18

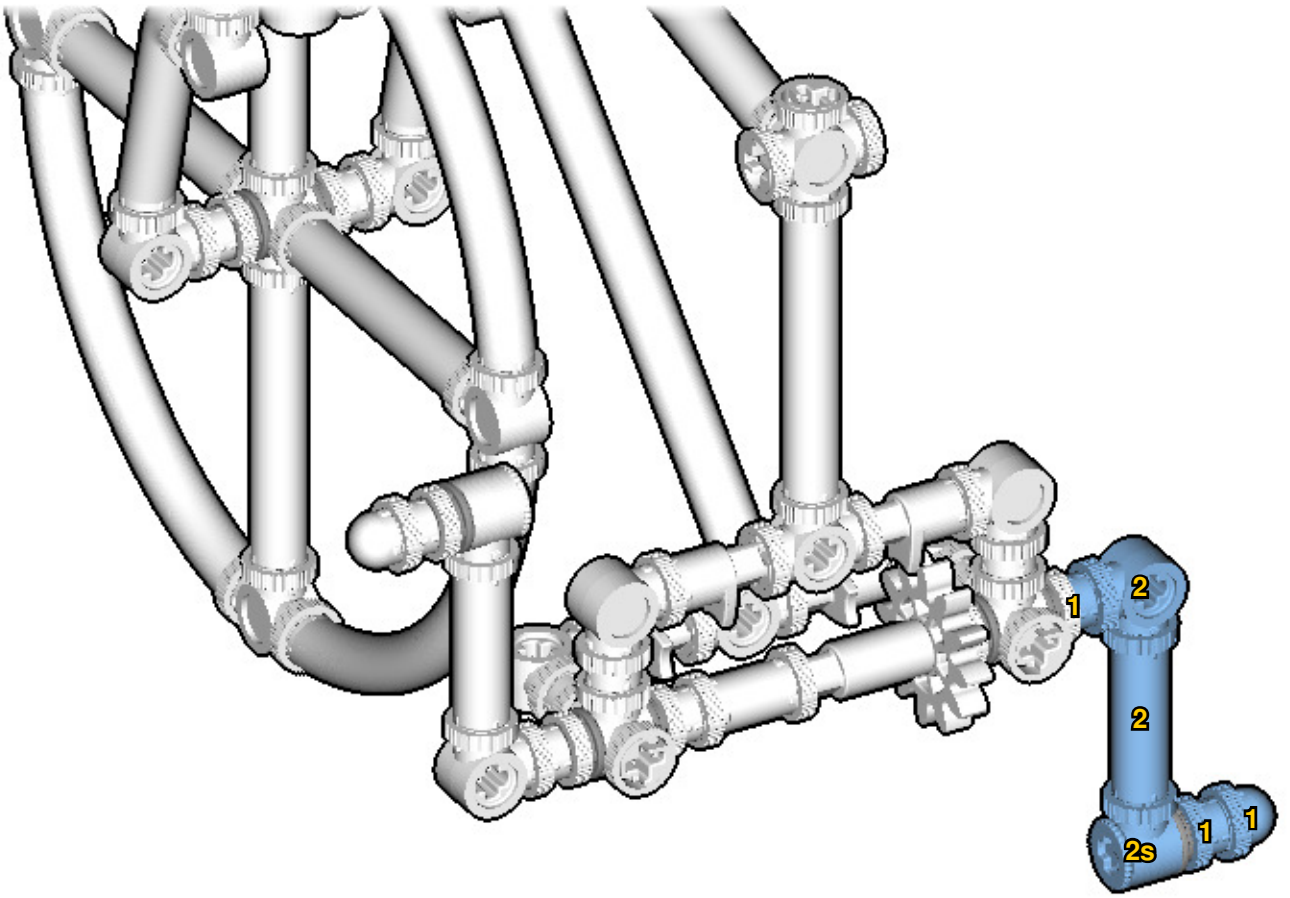



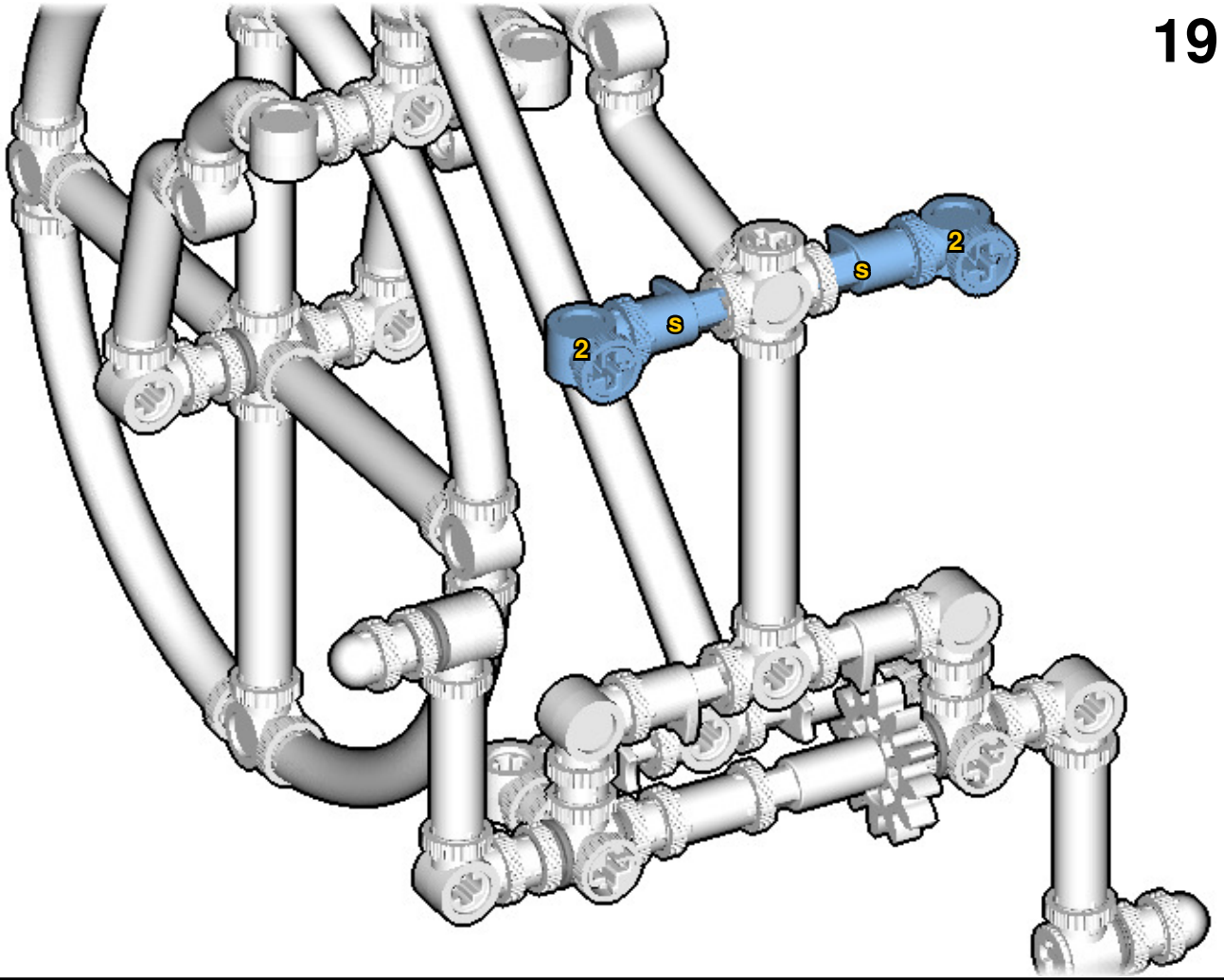

**axle\_g1 gear1**

Slide axle\_g1 through gear1 and join. Make hub face joint.

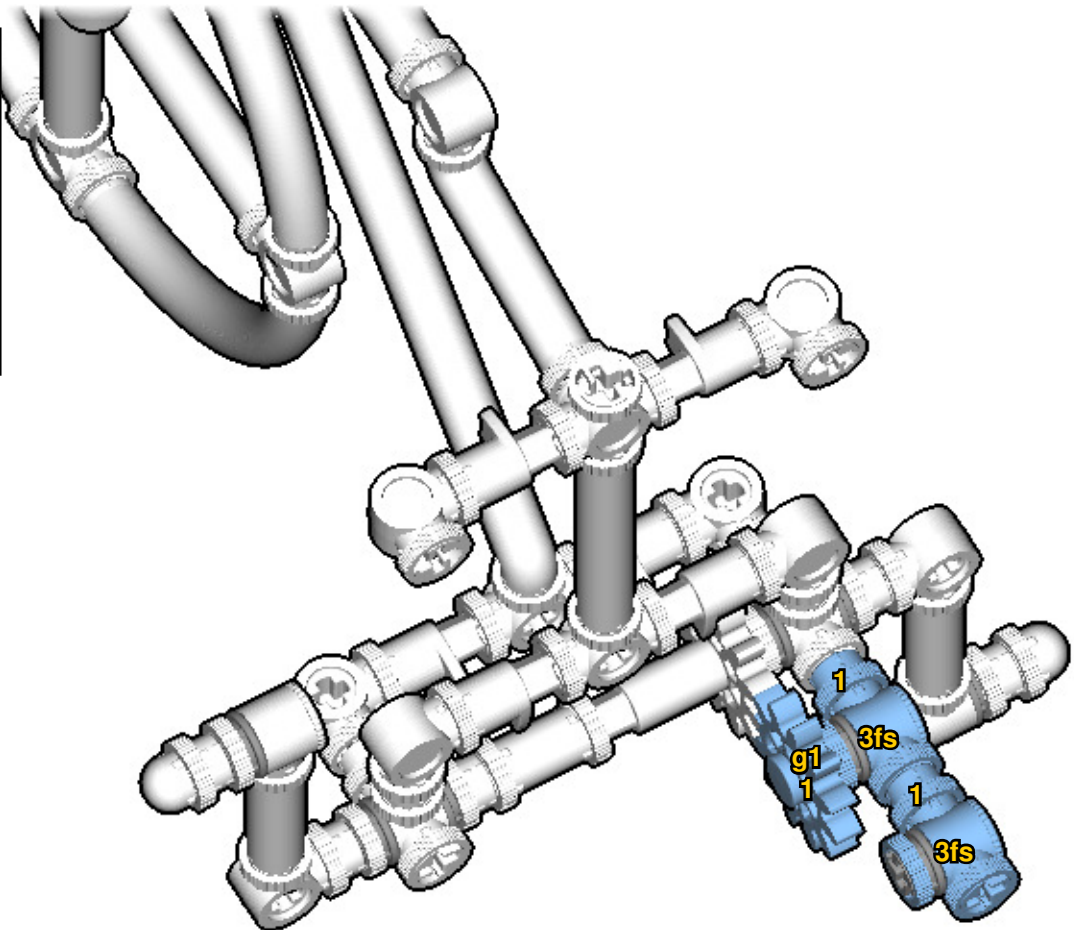
An inset diagram showing the assembly of an axle and a gear. It consists of three parts: a grey axle with a hole, a grey gear with a hole, and a grey axle with a hole. Yellow arrows indicate the assembly sequence: the axle is inserted into the gear, and then another axle is inserted into the gear's hole.

**axle\_g1 gear3s**

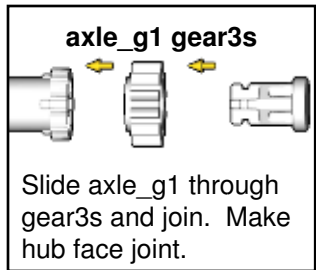

Slide axle\_g1 through gear3s and join. Make hub face joint.

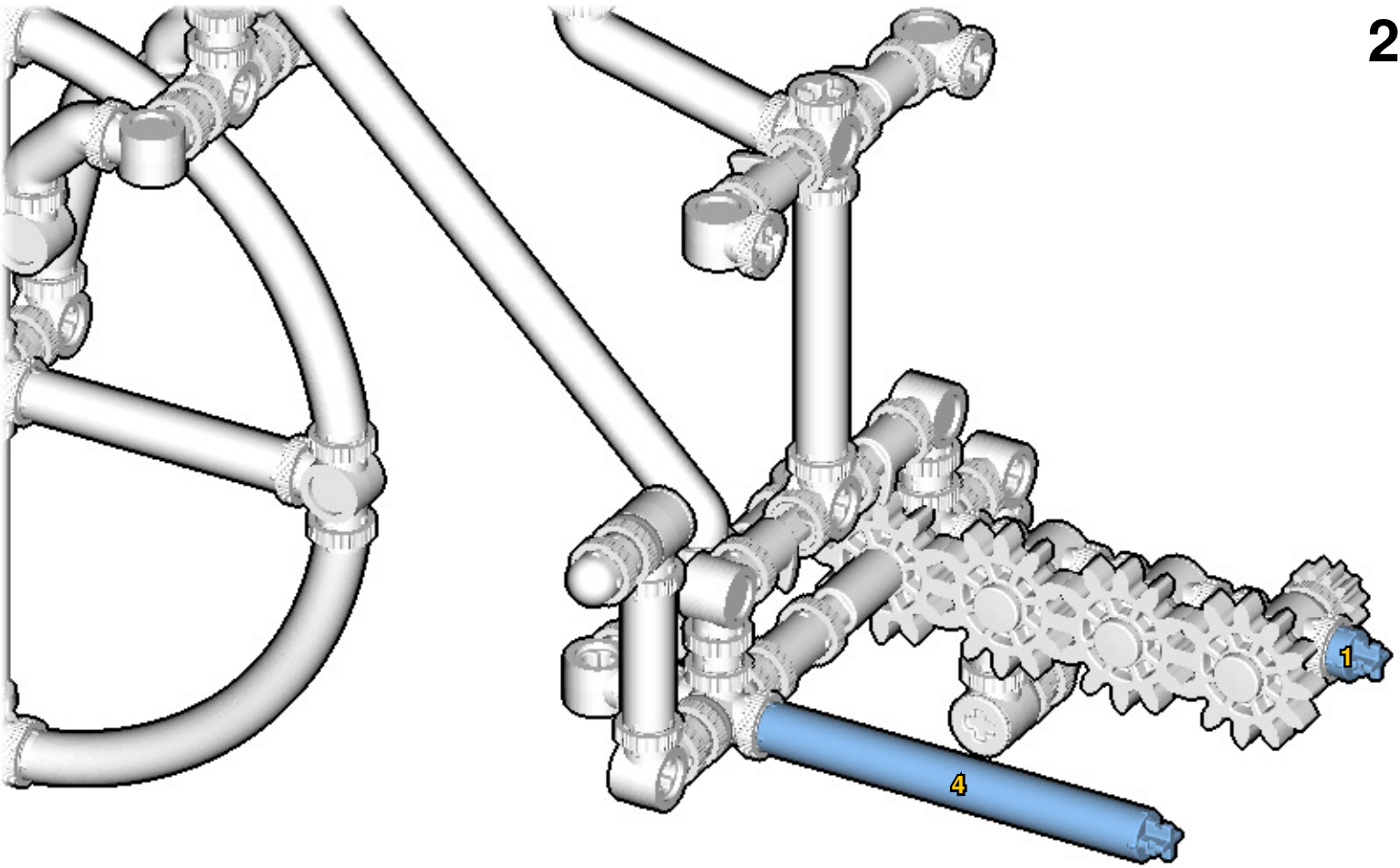
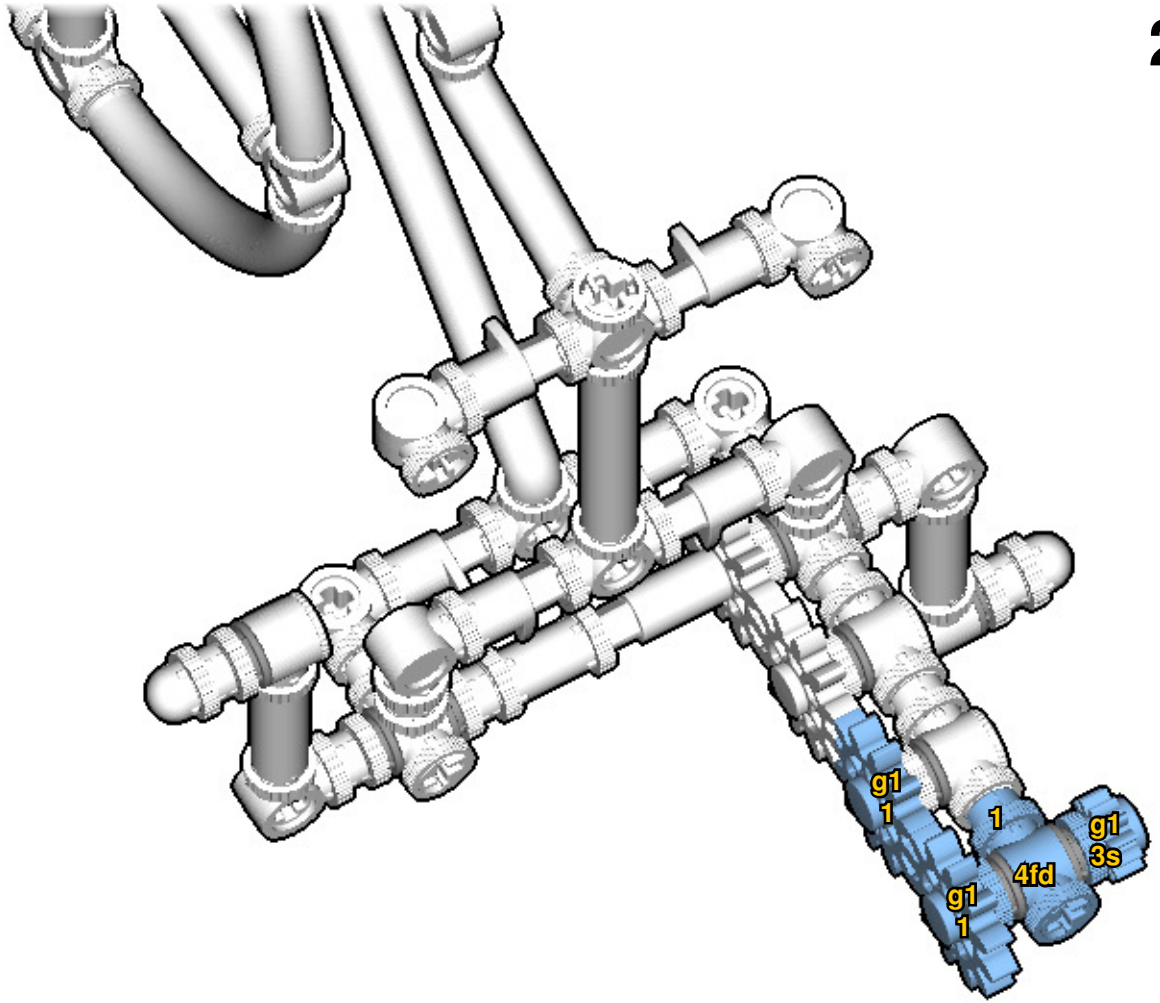

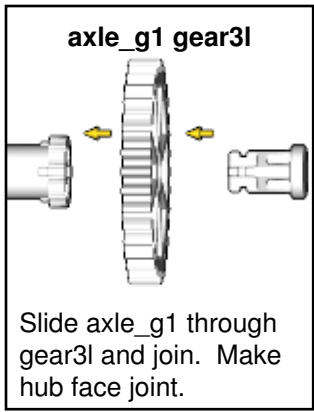

**23**



**24**

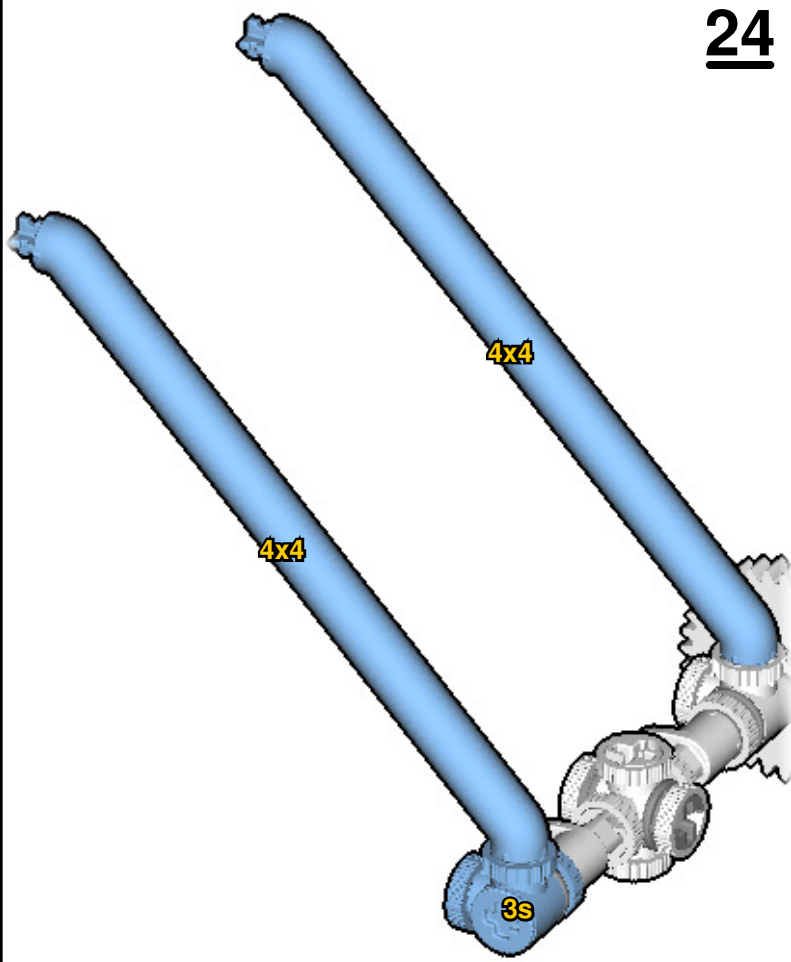

**25**

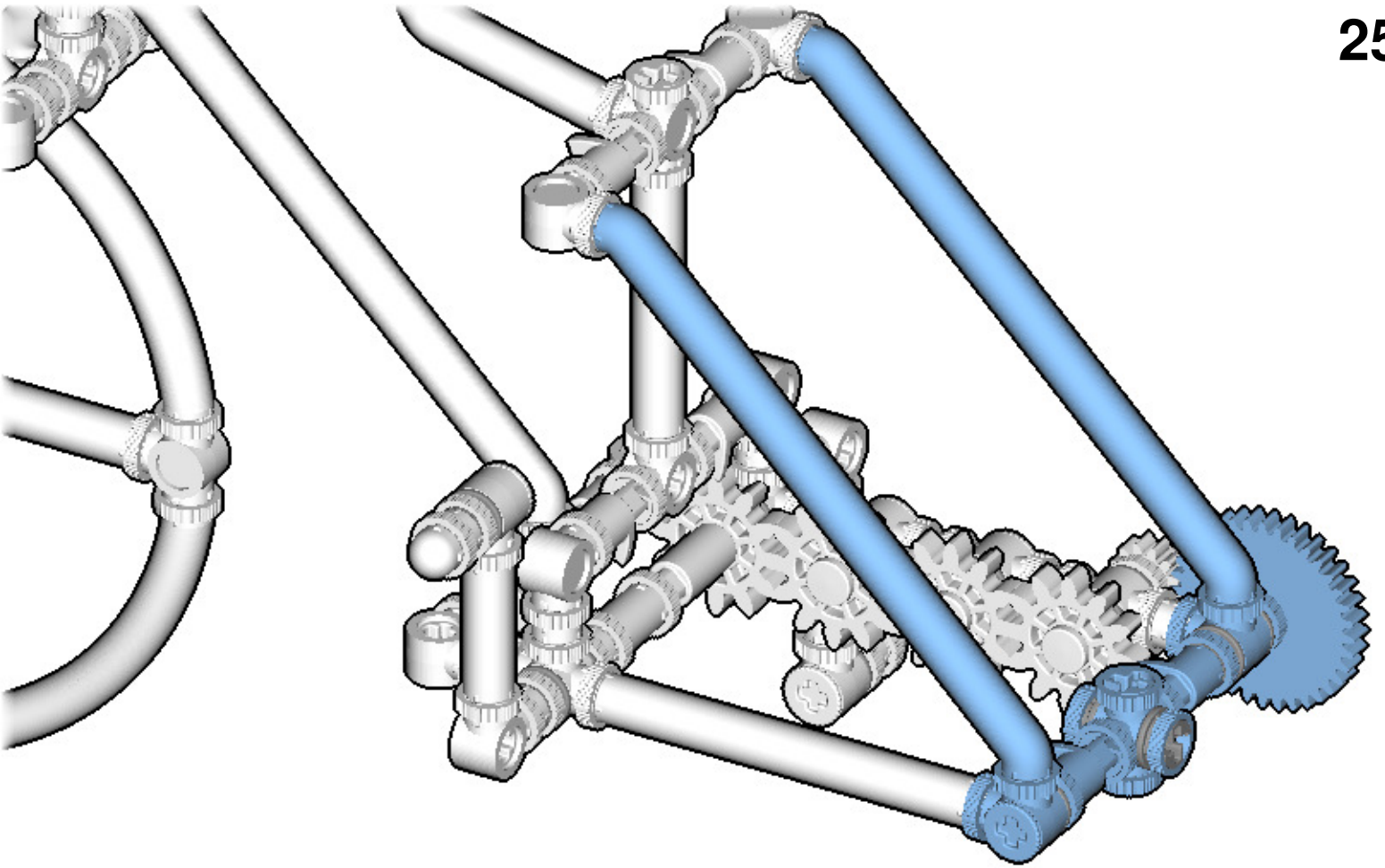

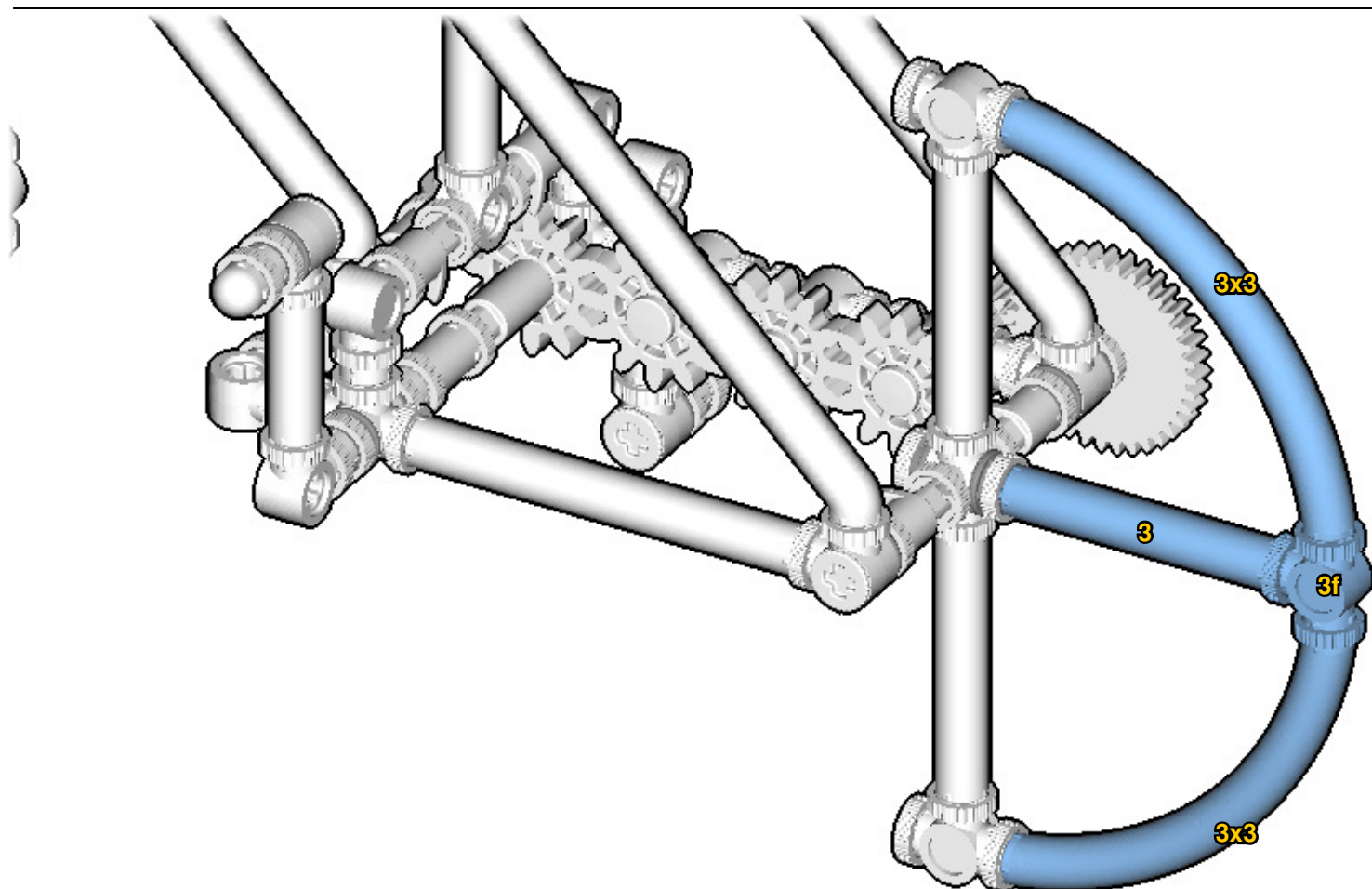
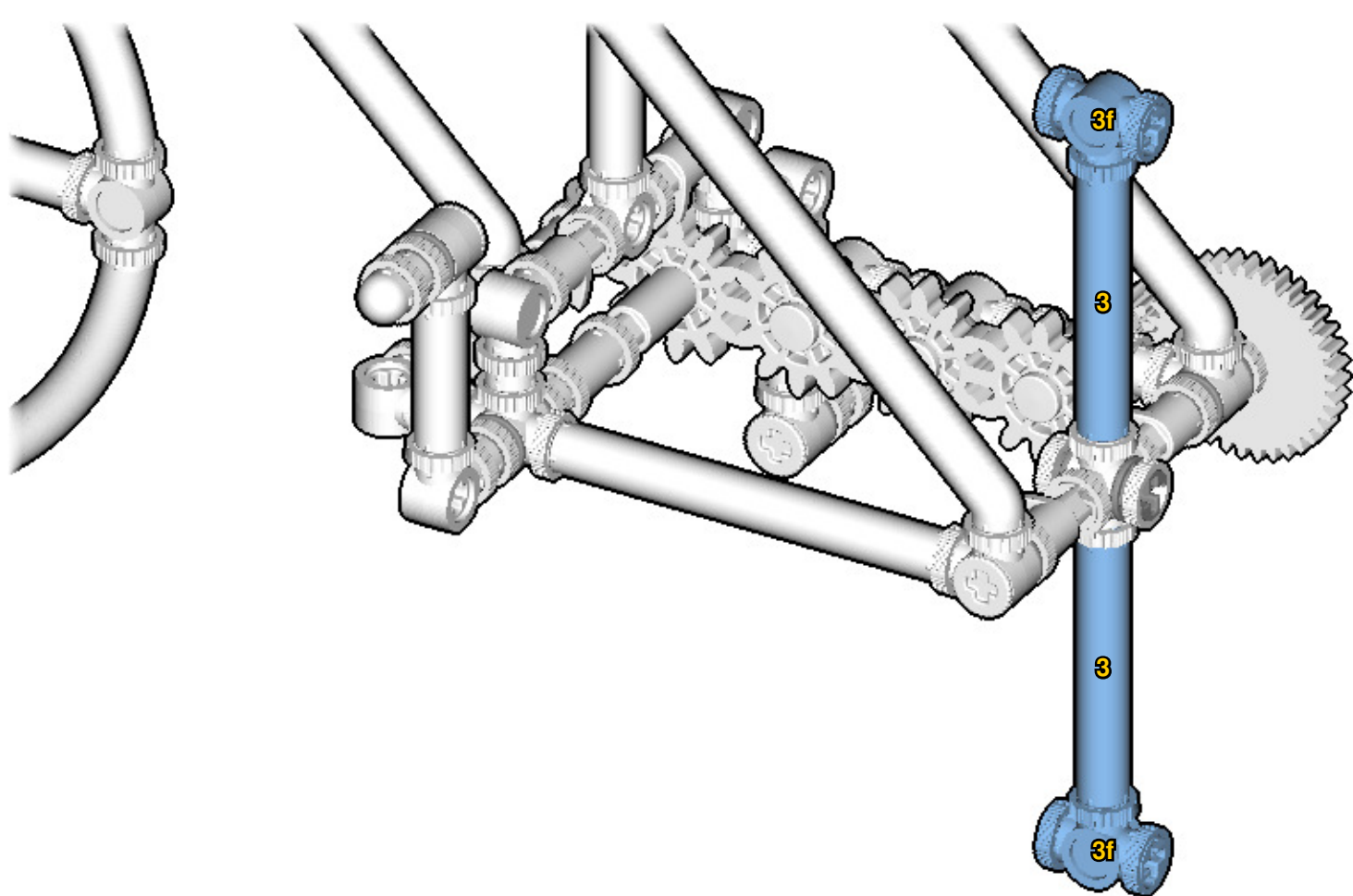

28

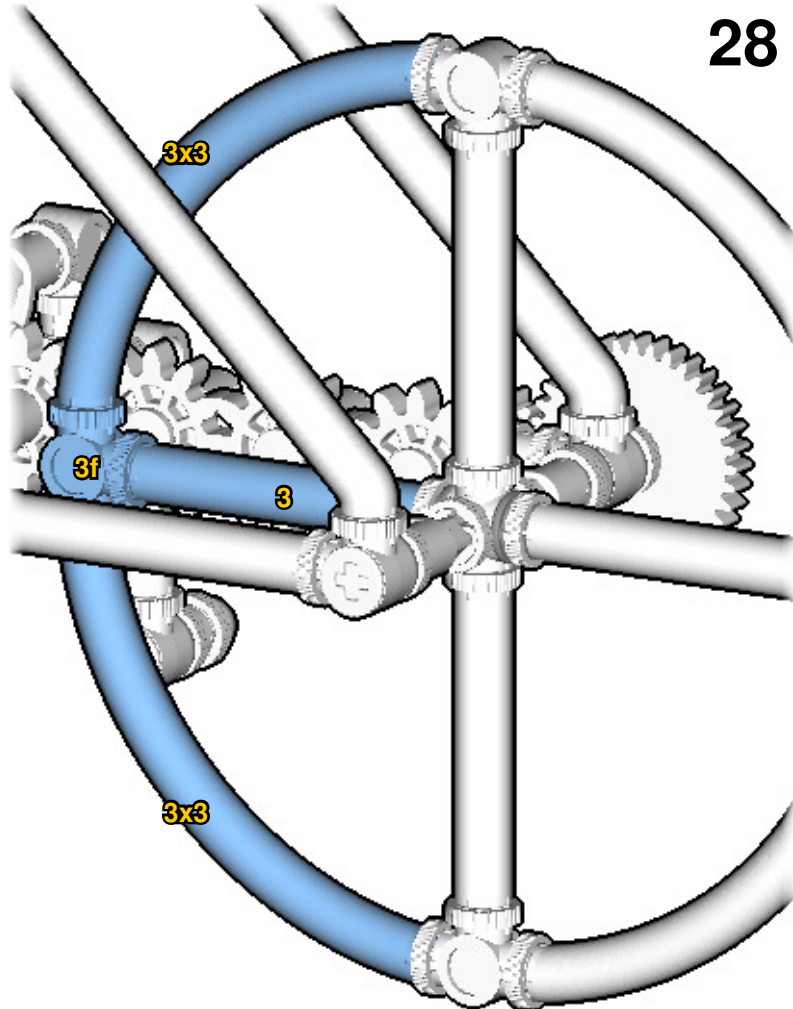

29

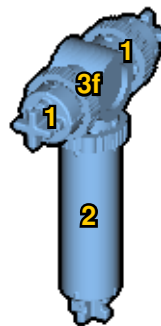

30

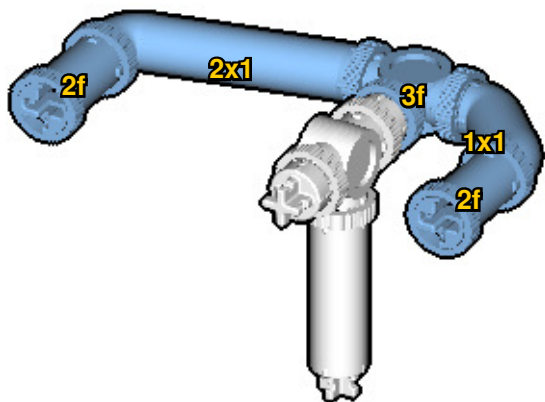

31

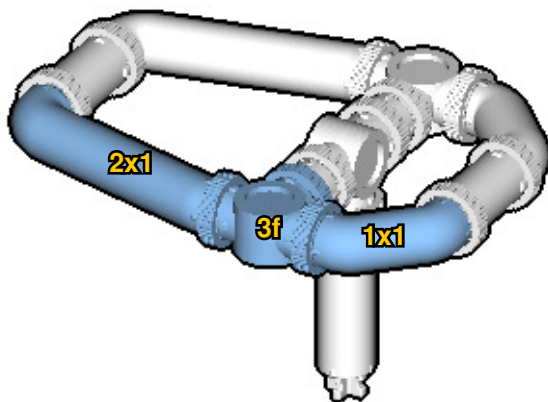

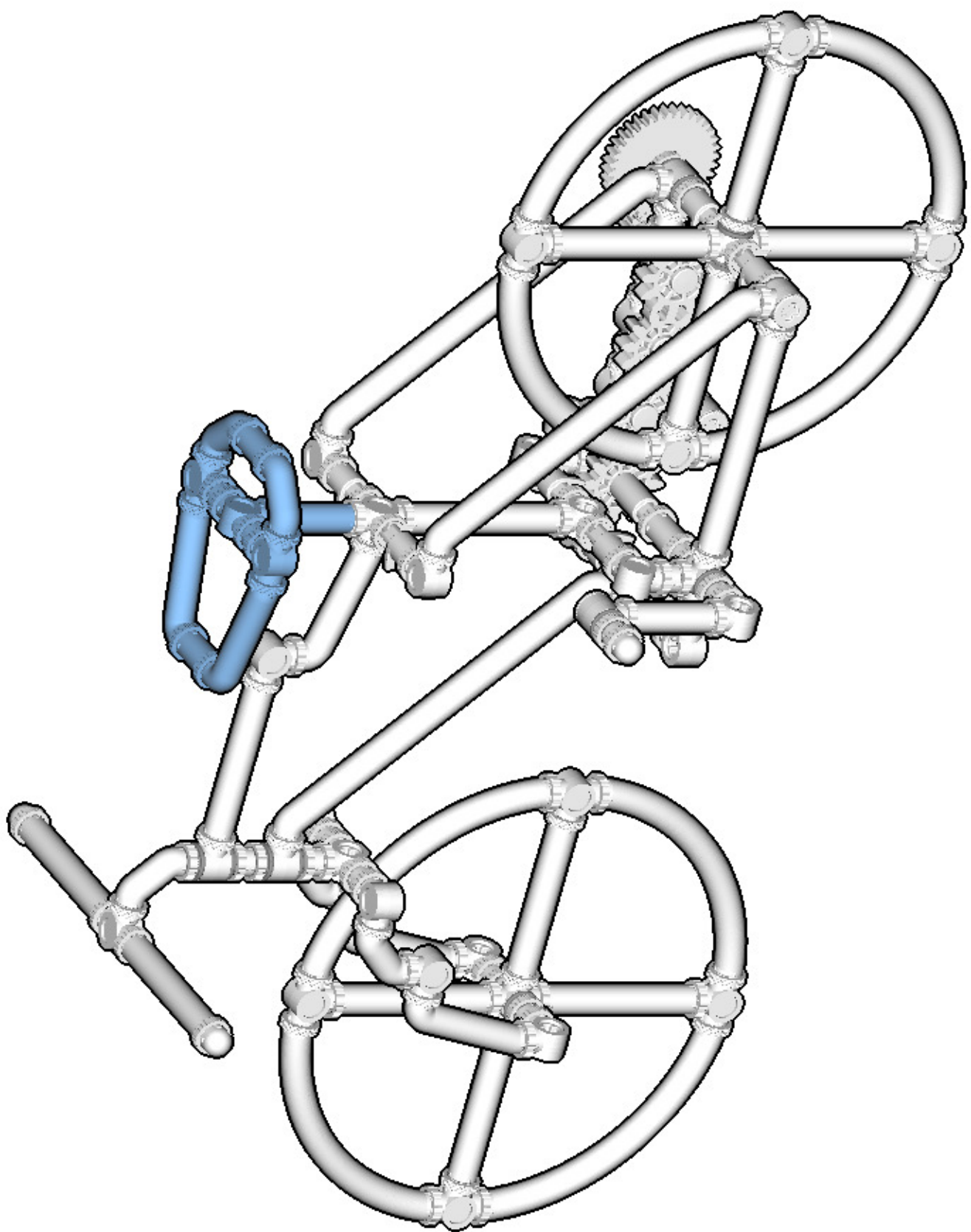

# INVENTORY

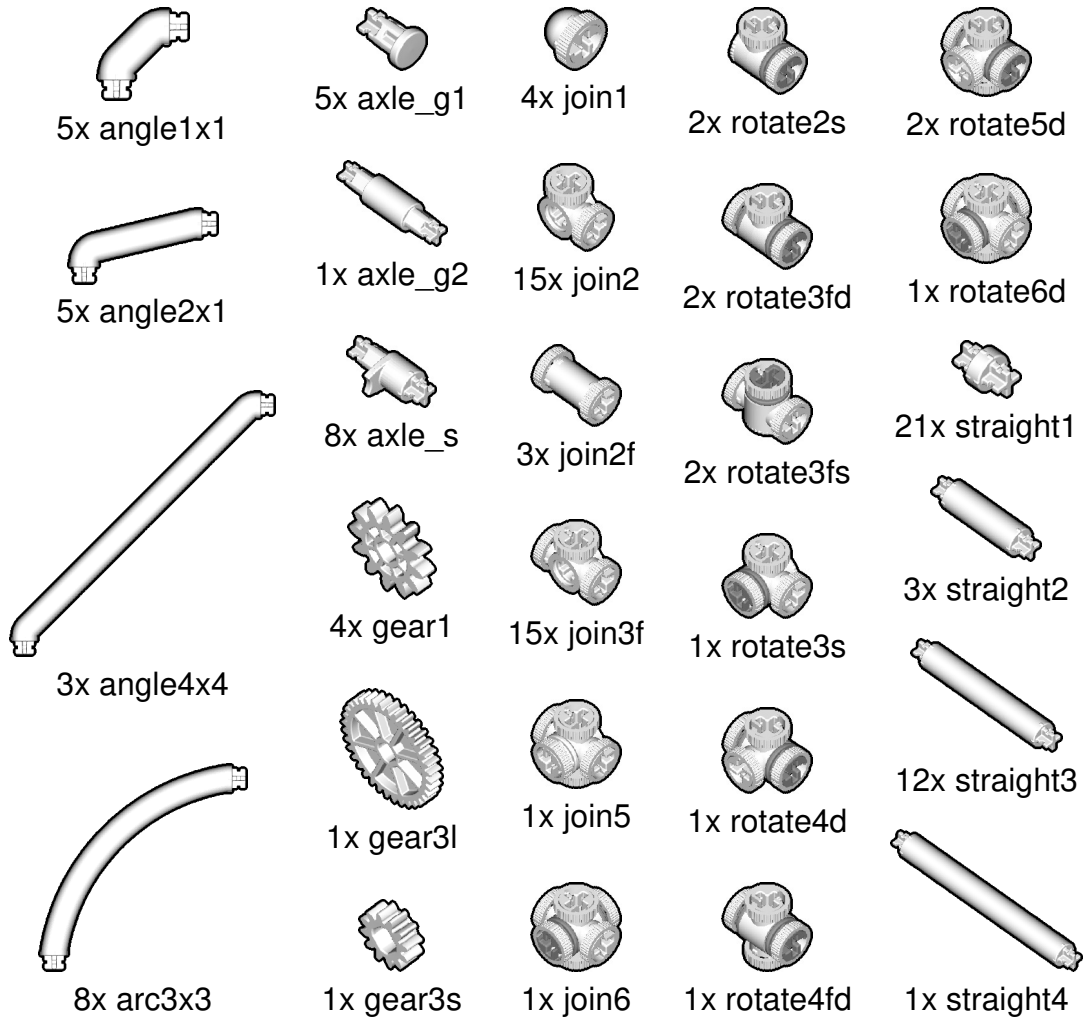

# ACTUAL SIZE

