

DOLPHIN

| | | | |
|----------|-----------------------|---------|--------|
| SIZE | 2.6ft x 1.2ft x 0.7ft | PIECES | 212 |
| DESIGNER | Charles Sharman | MADE IN | U.S.A. |

⚠ WARNING: Small parts. Age 12+. Handle responsibly. U.S. Patent 9,086,087.

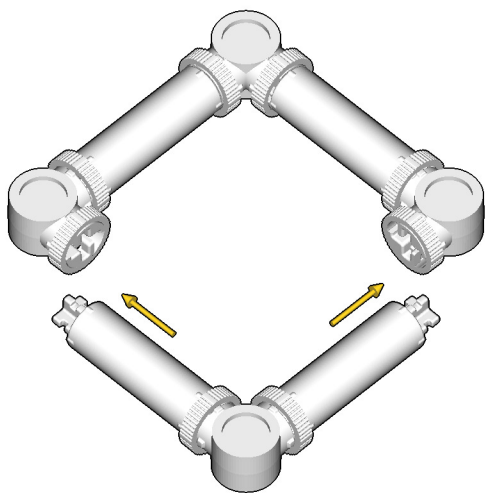
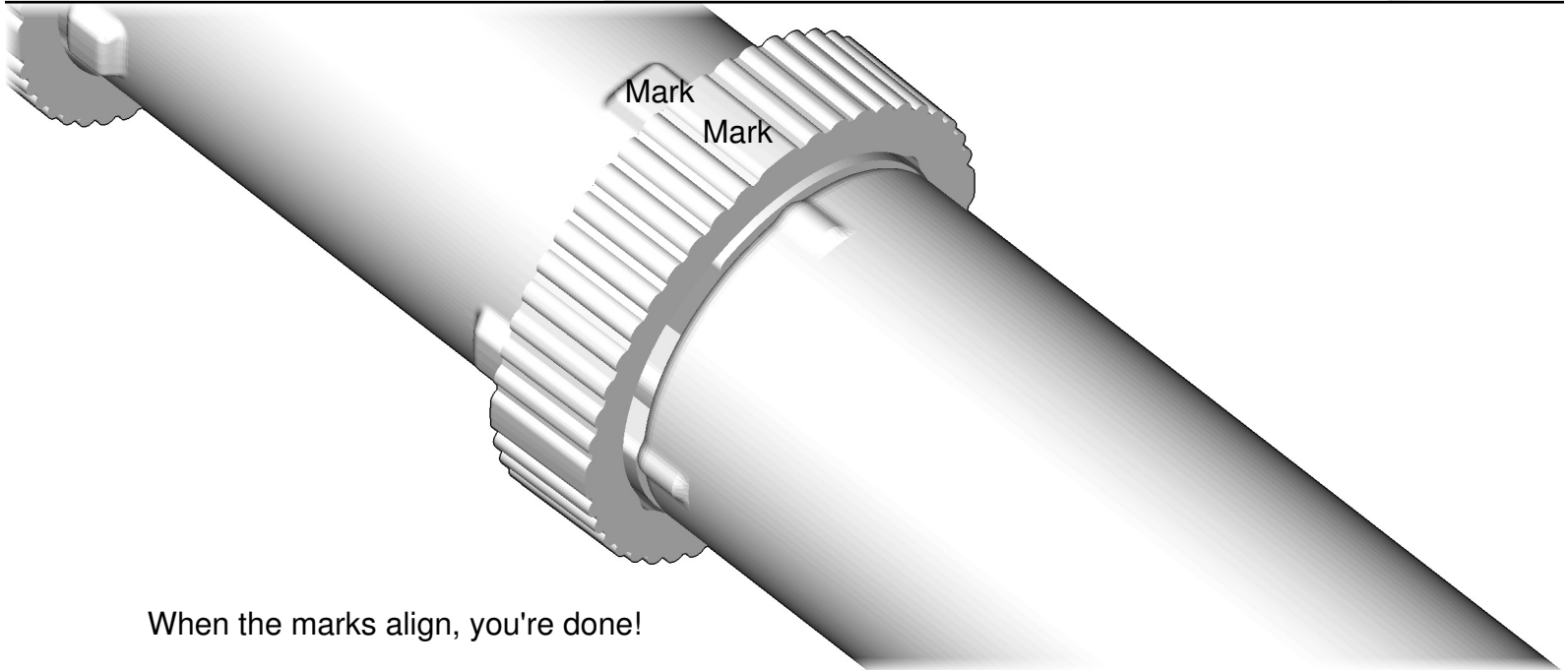
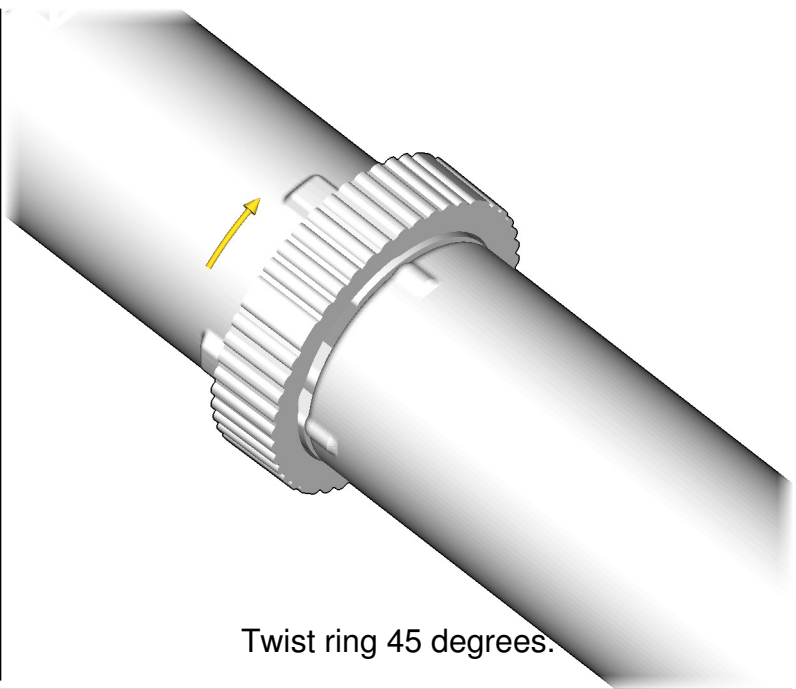
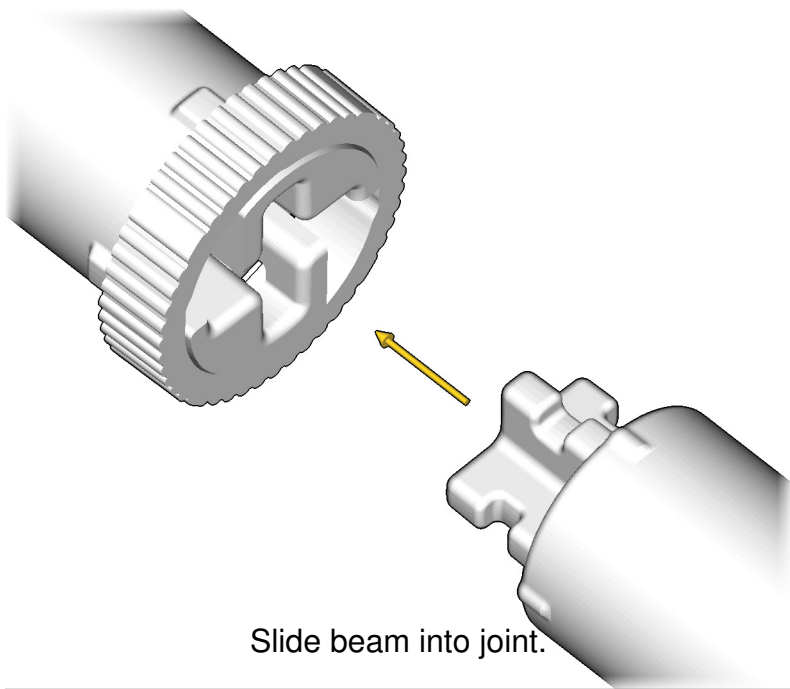

Wrong
Connecting/Disconnecting Two Directions

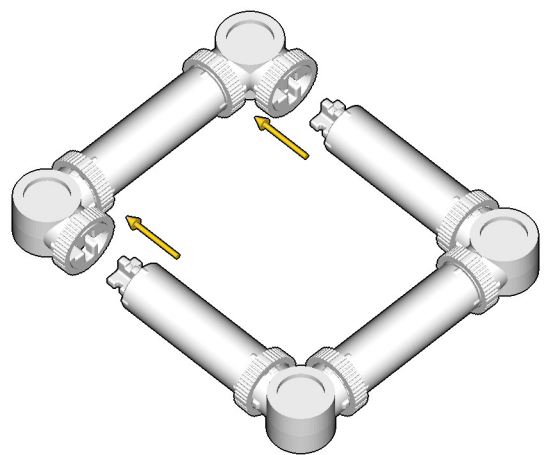

Right
Connecting/Disconnecting One Direction

1

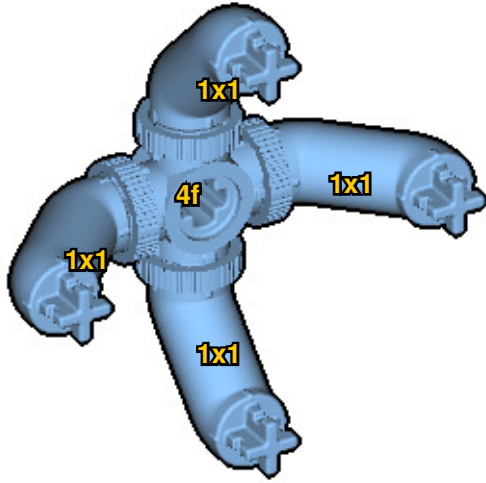

New pieces are drawn blue. Old pieces are drawn white.
See back for piece names.

2

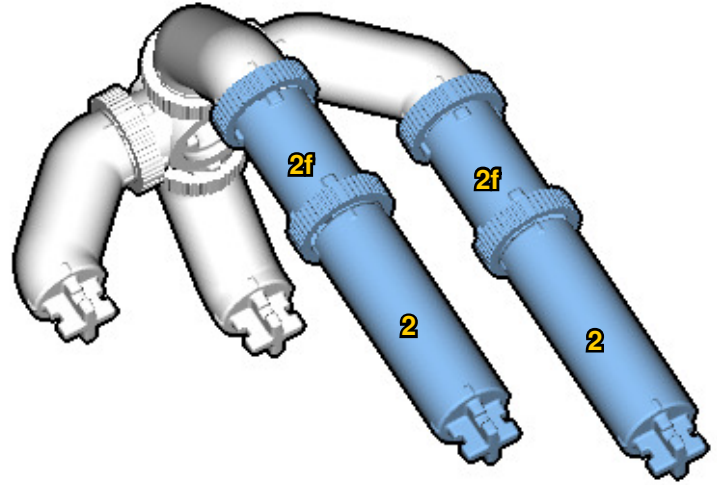

Connect new pieces together before connecting to old pieces.

3

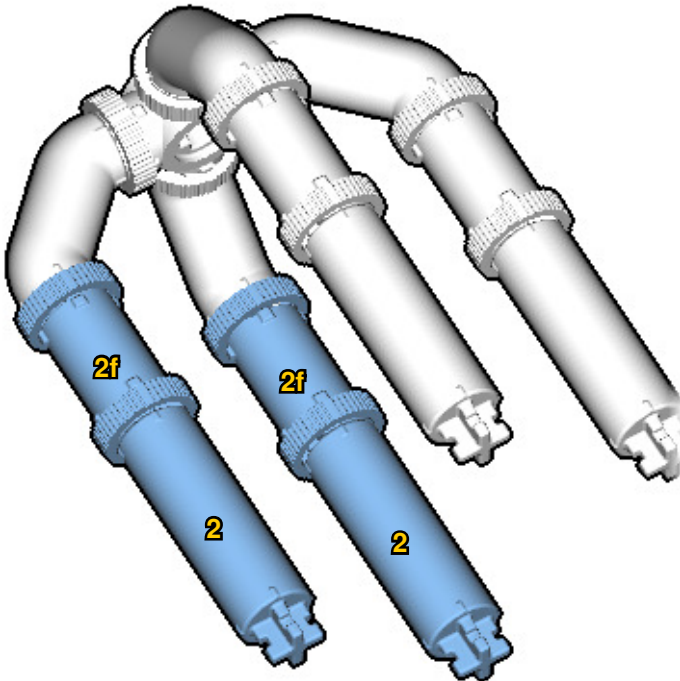

4

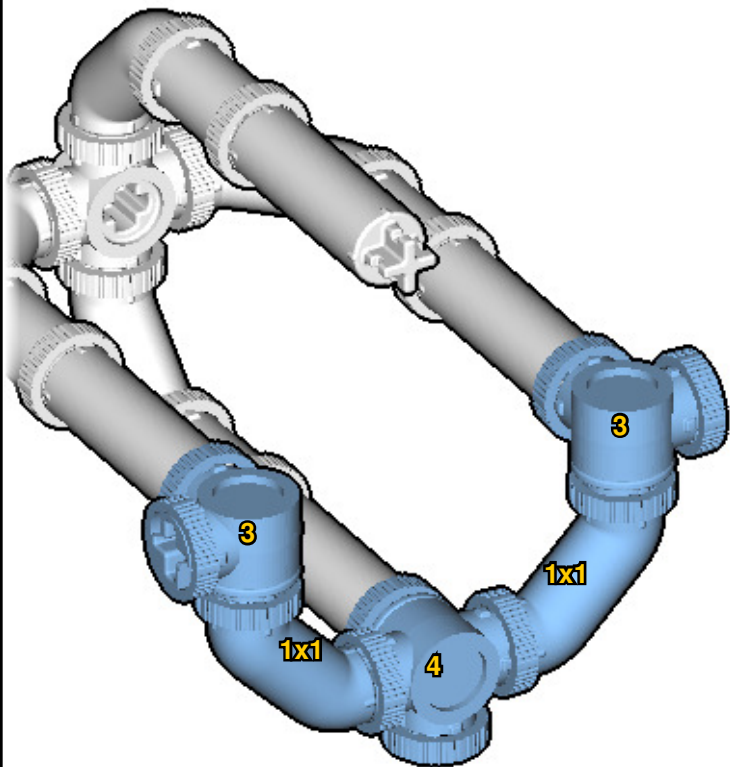

5

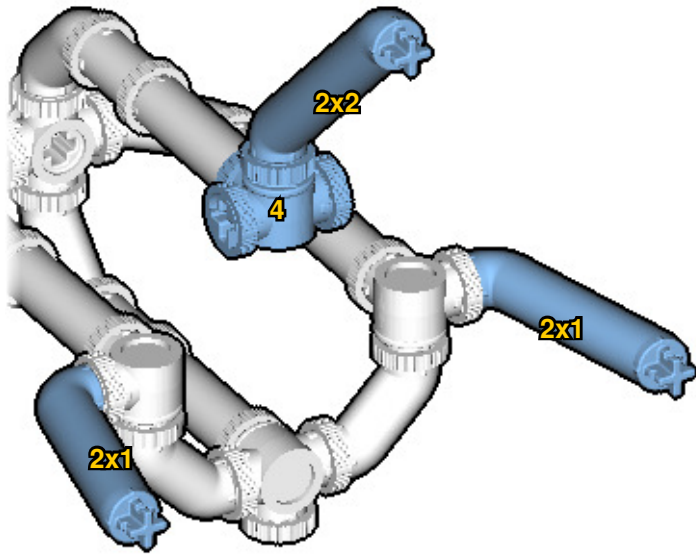

6

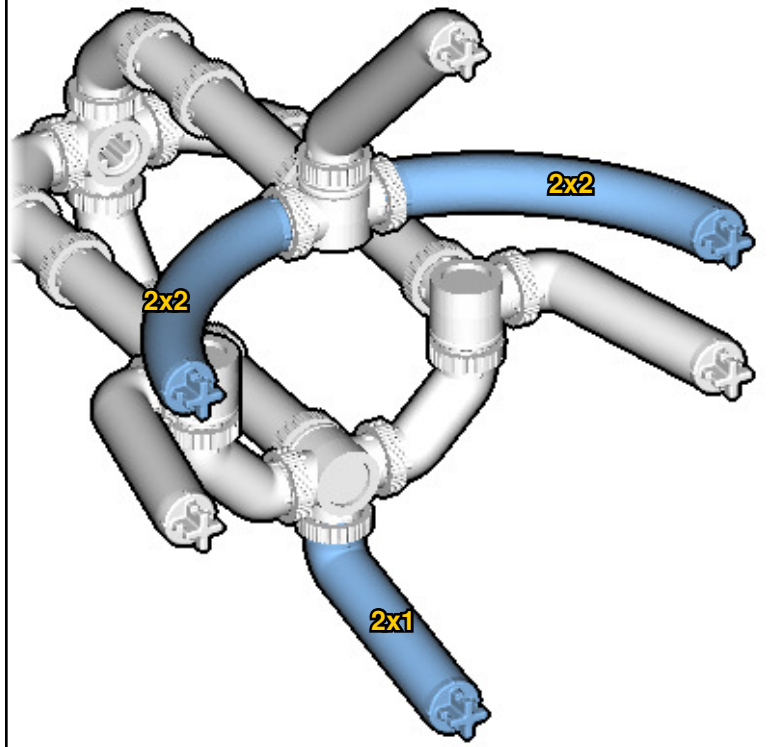

Submodel begins → 7

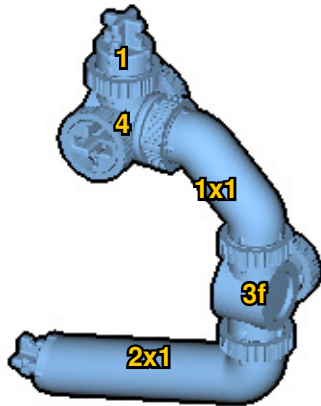

8

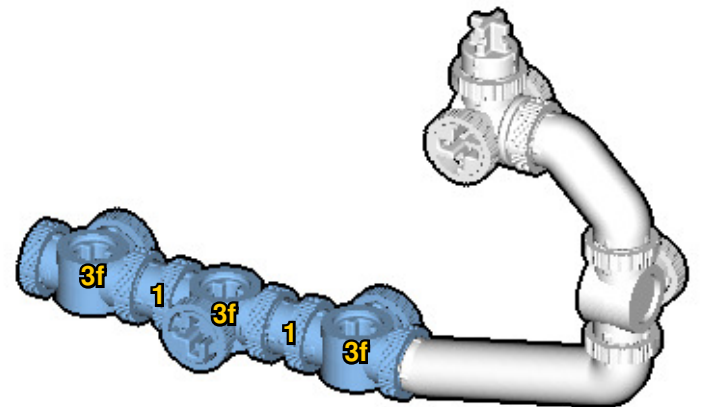

9

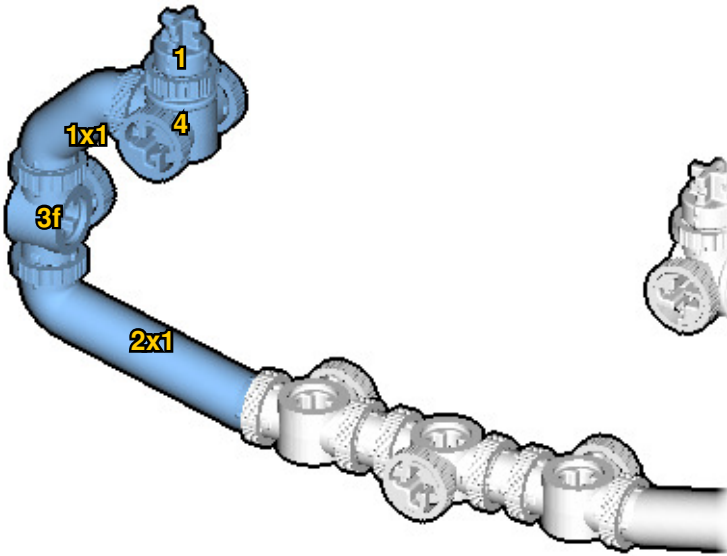

10

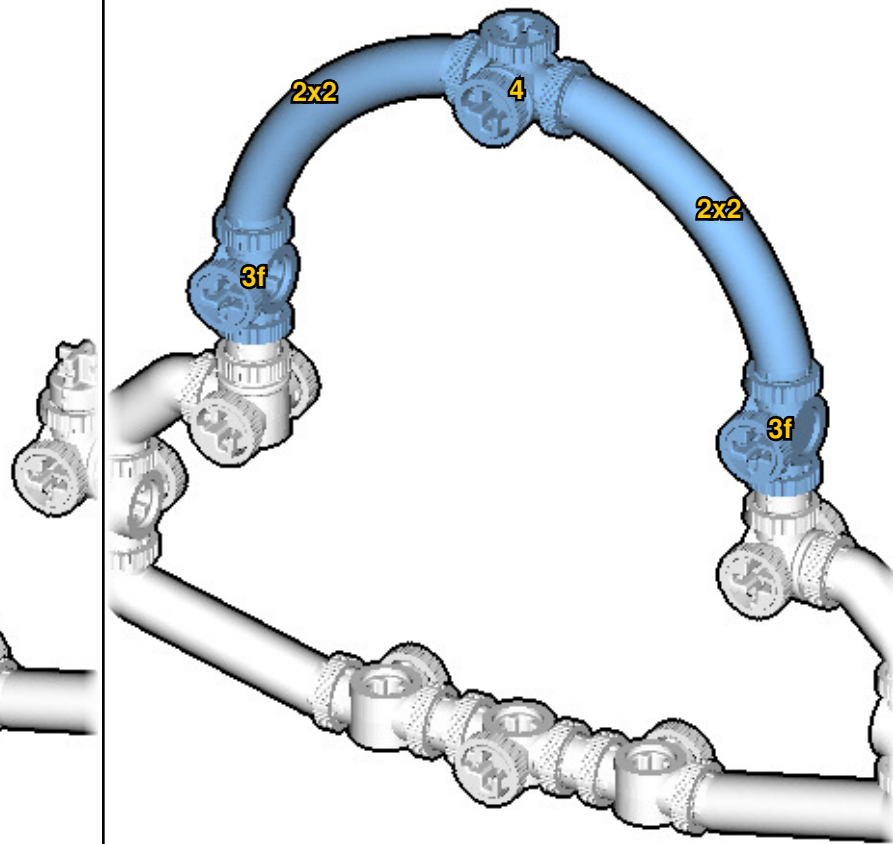

Submodel ends → 11

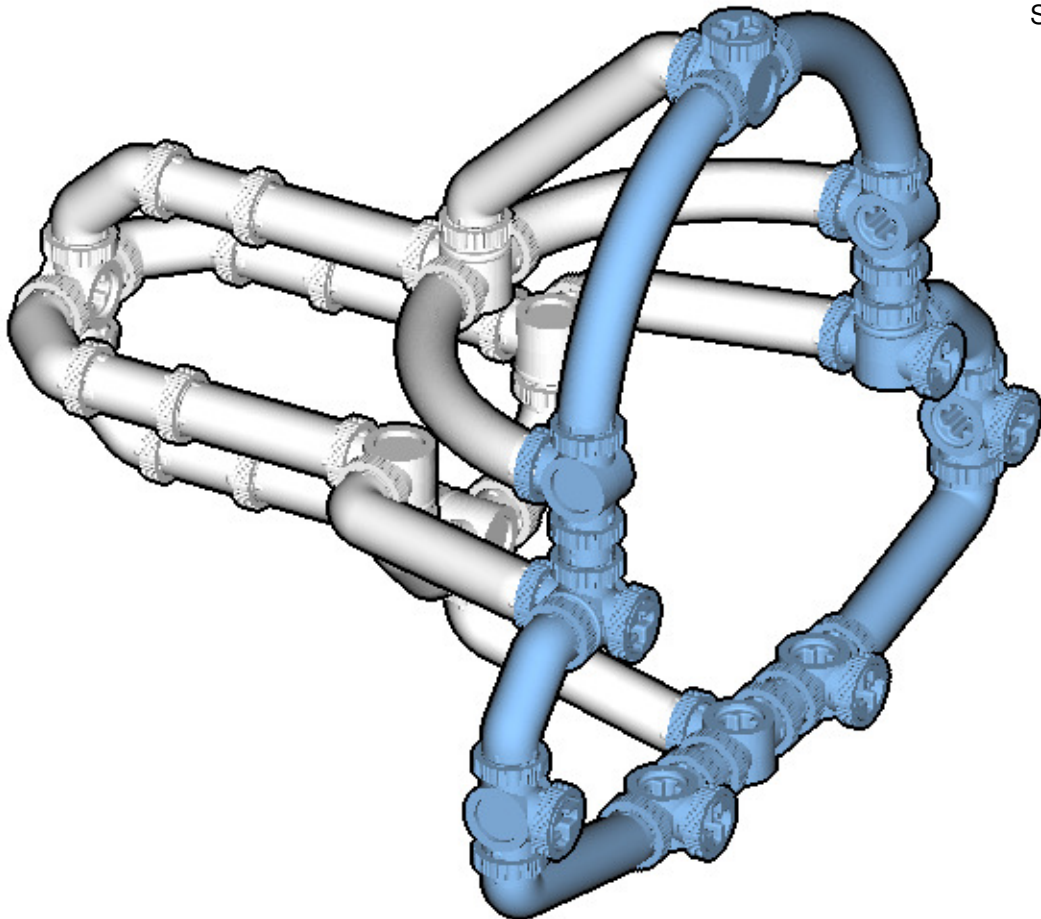

Connect submodel to model.

12

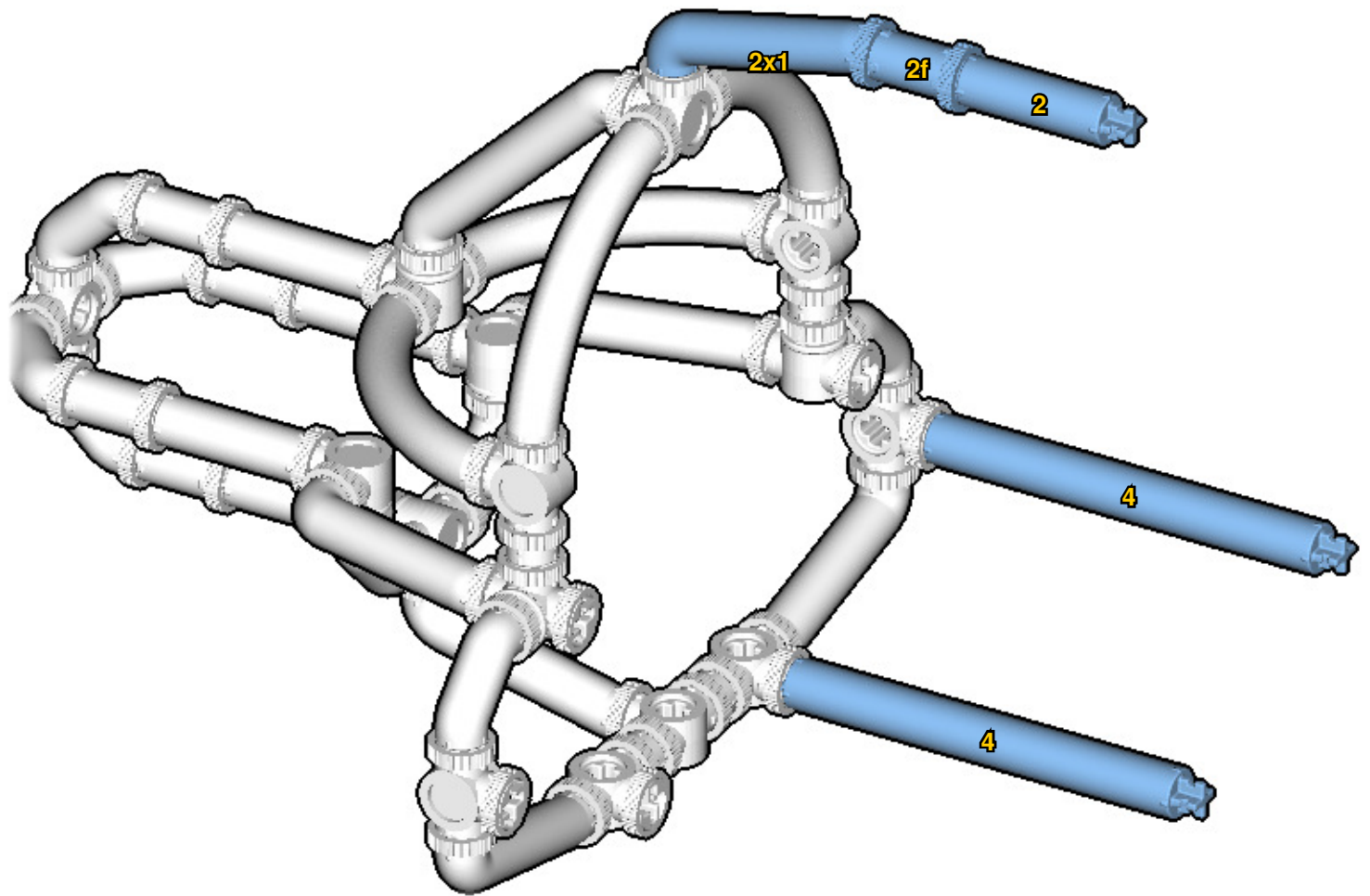

13

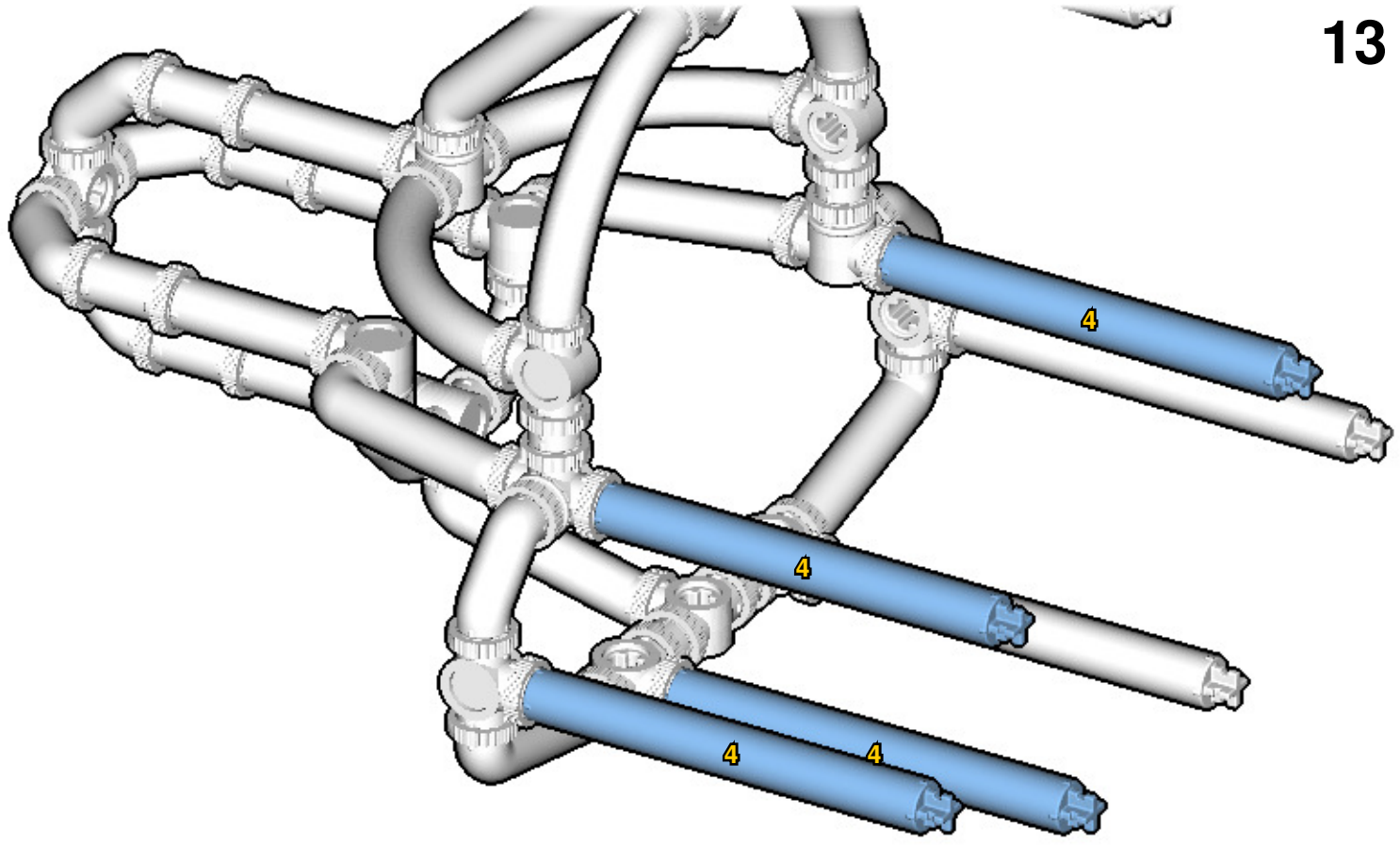

14

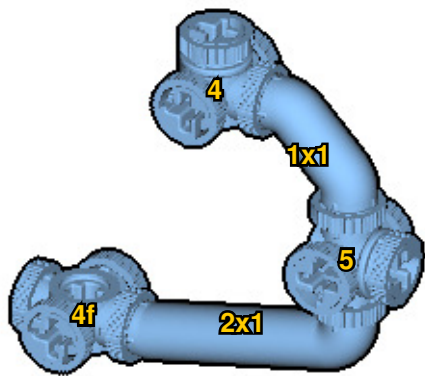

15

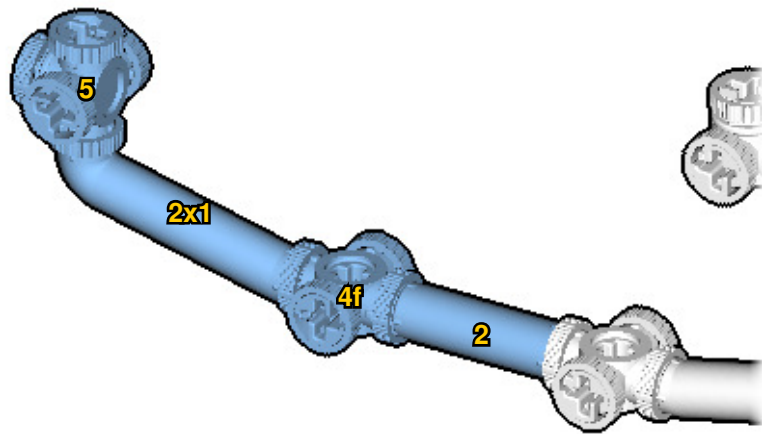

16

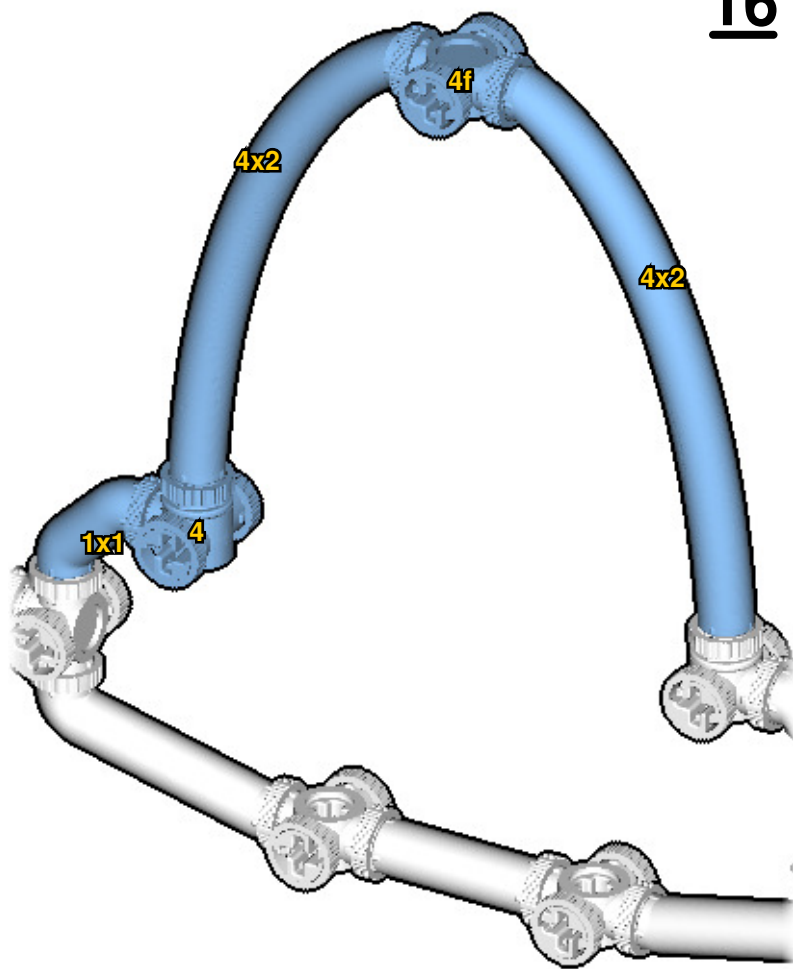

17

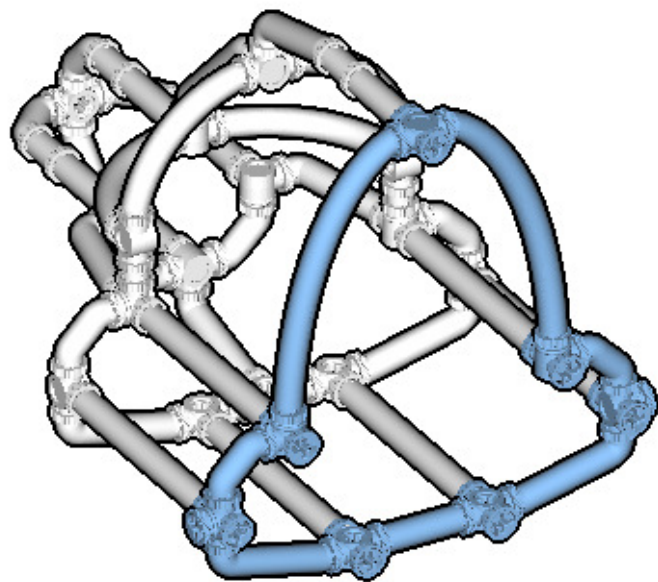

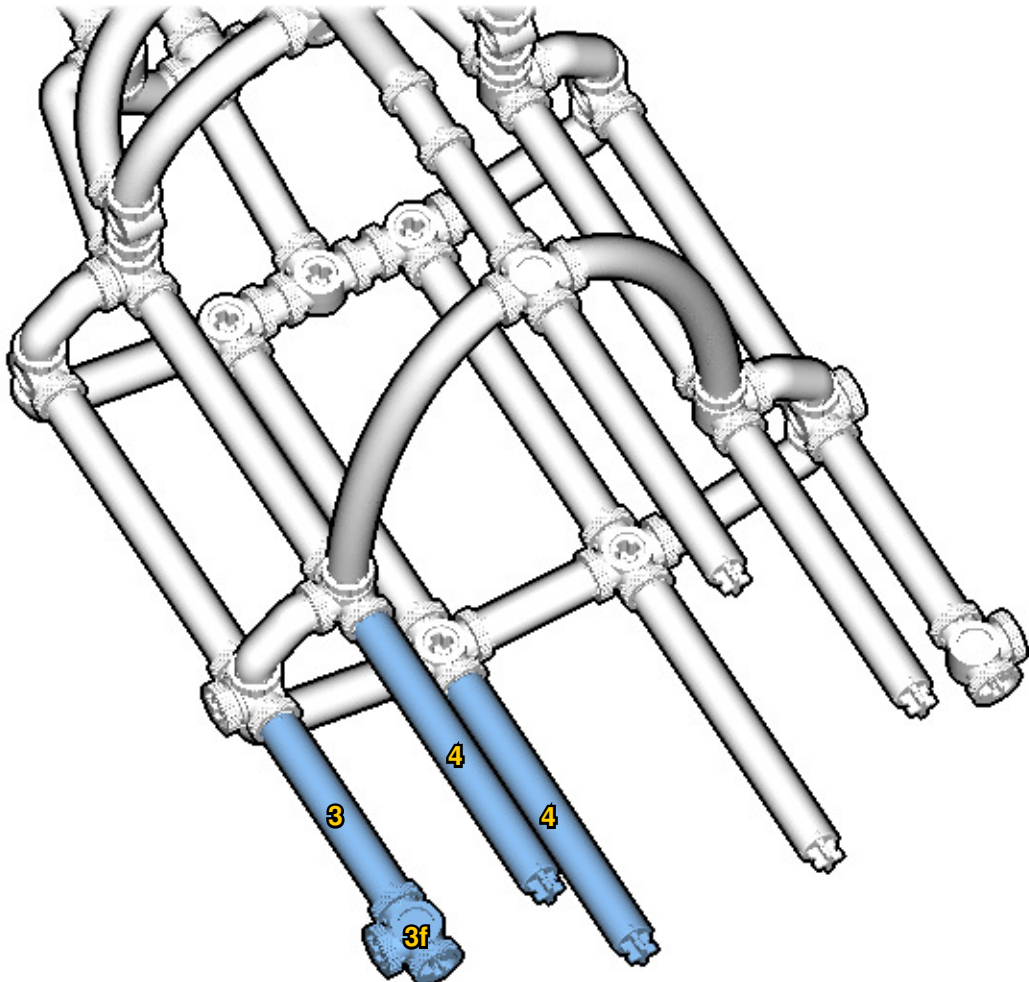
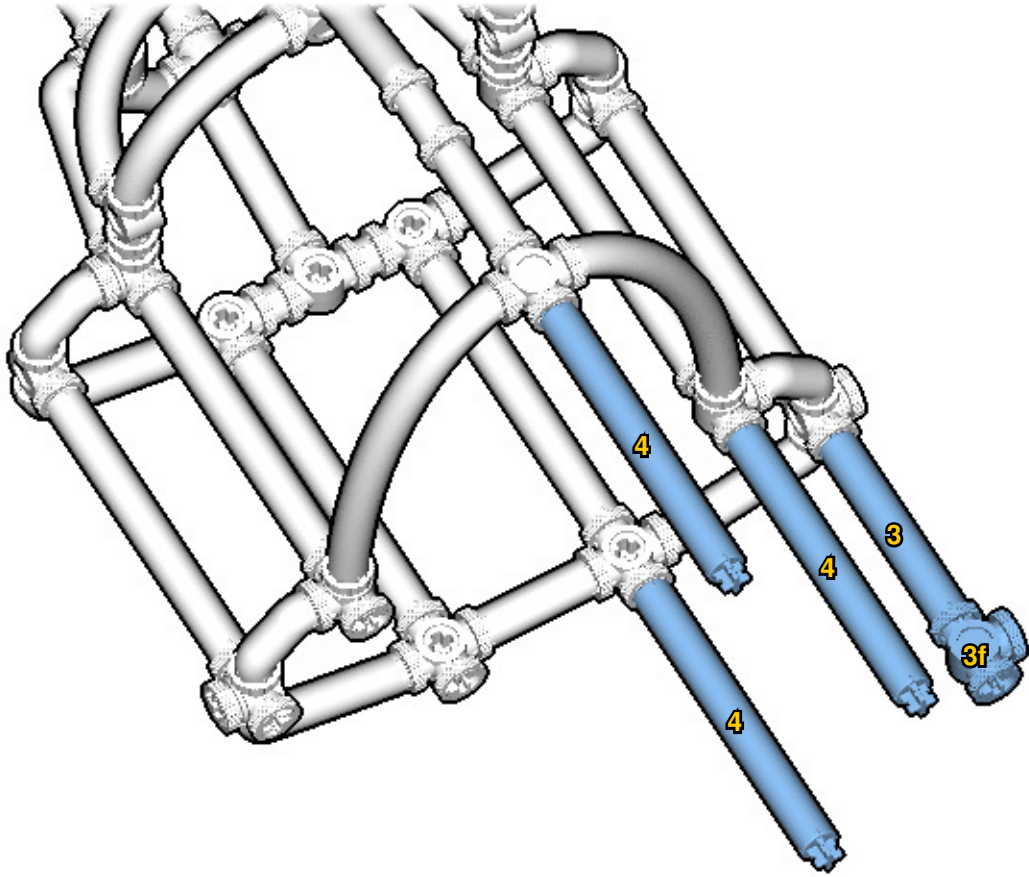

20

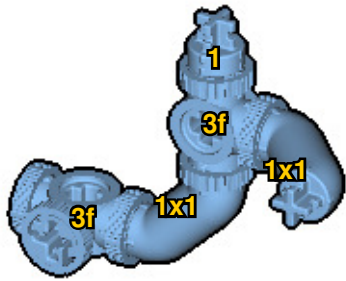

21

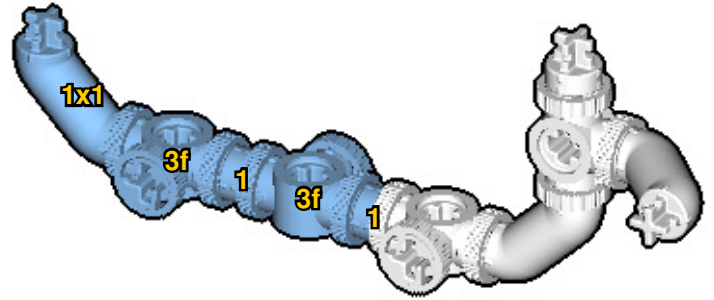

22

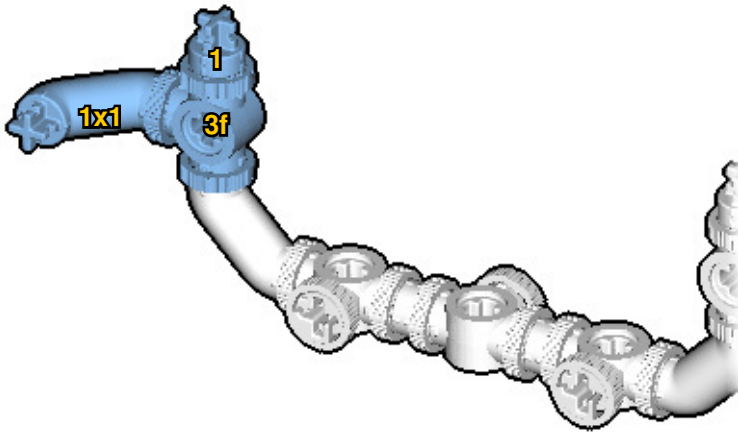

23

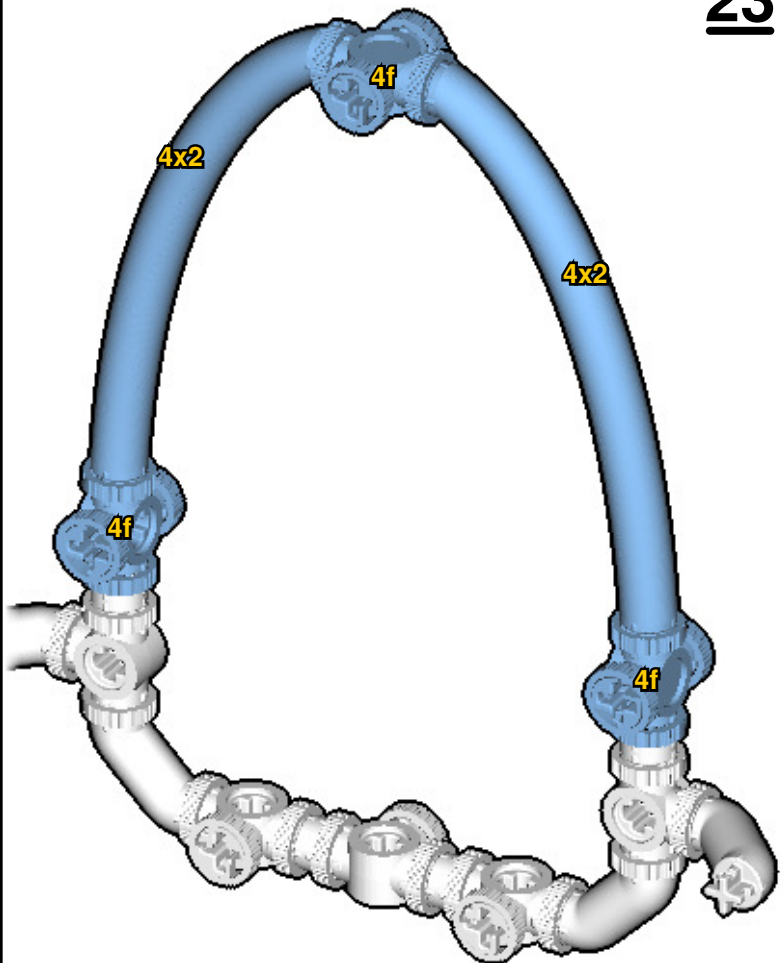

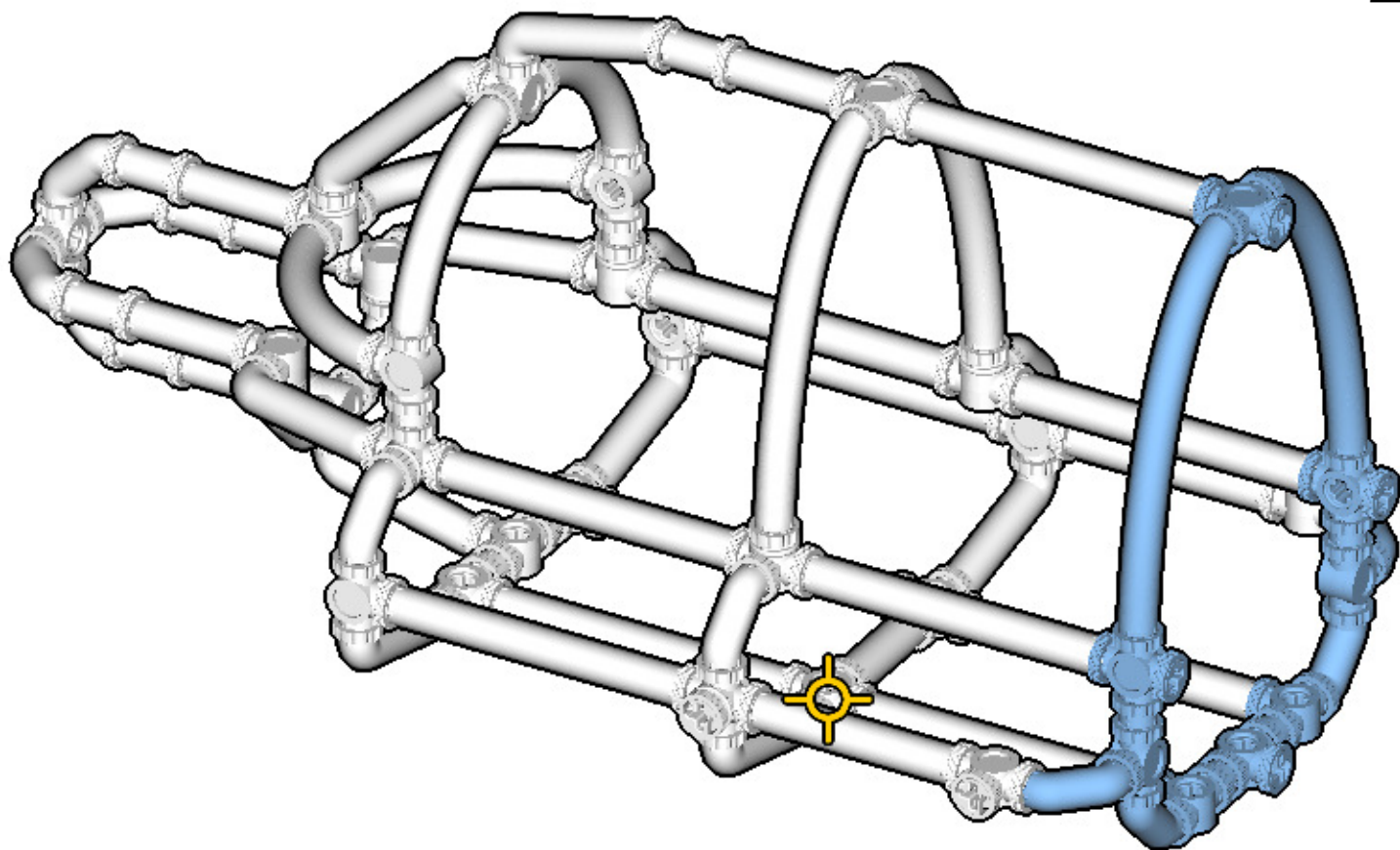

✦ : The next frame is centered on this piece.

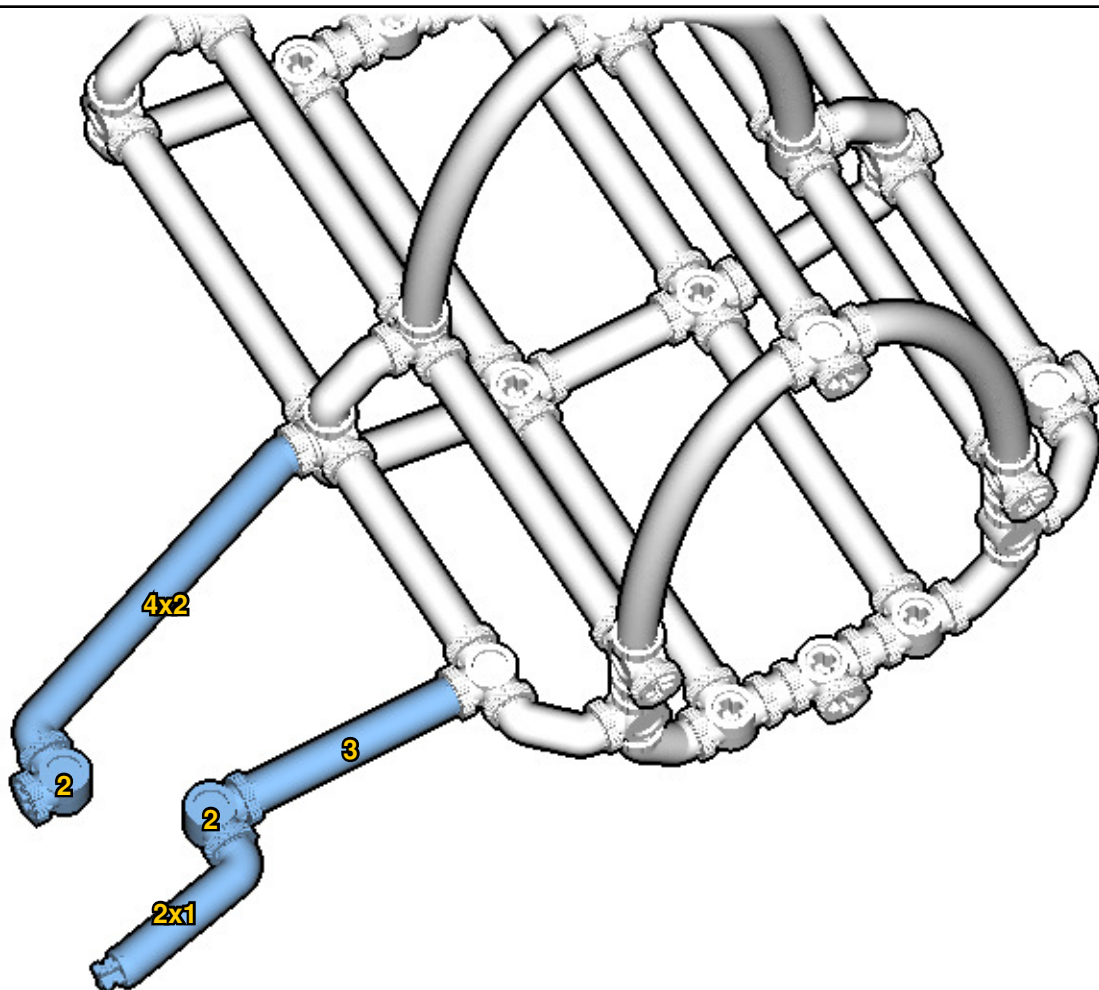

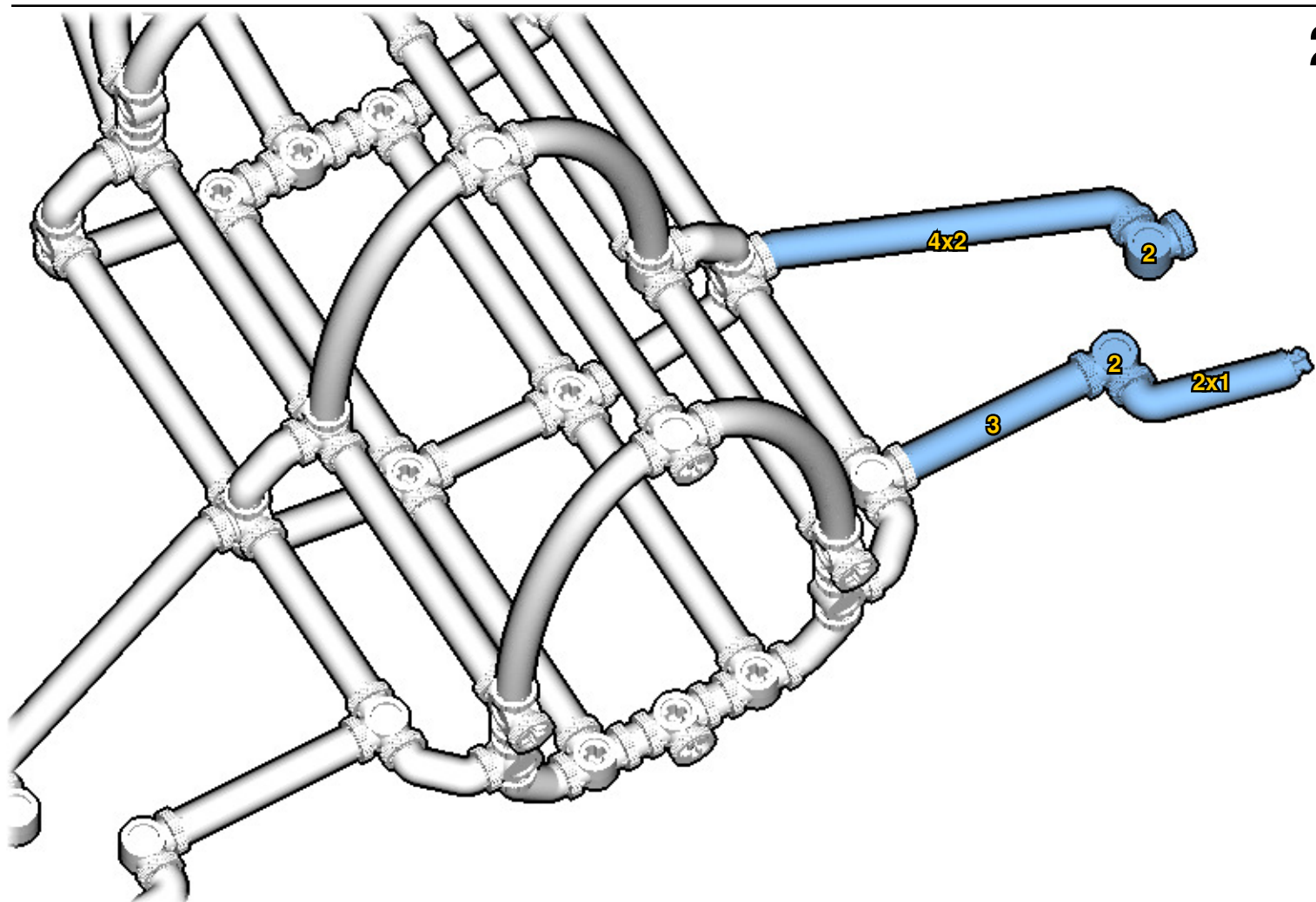
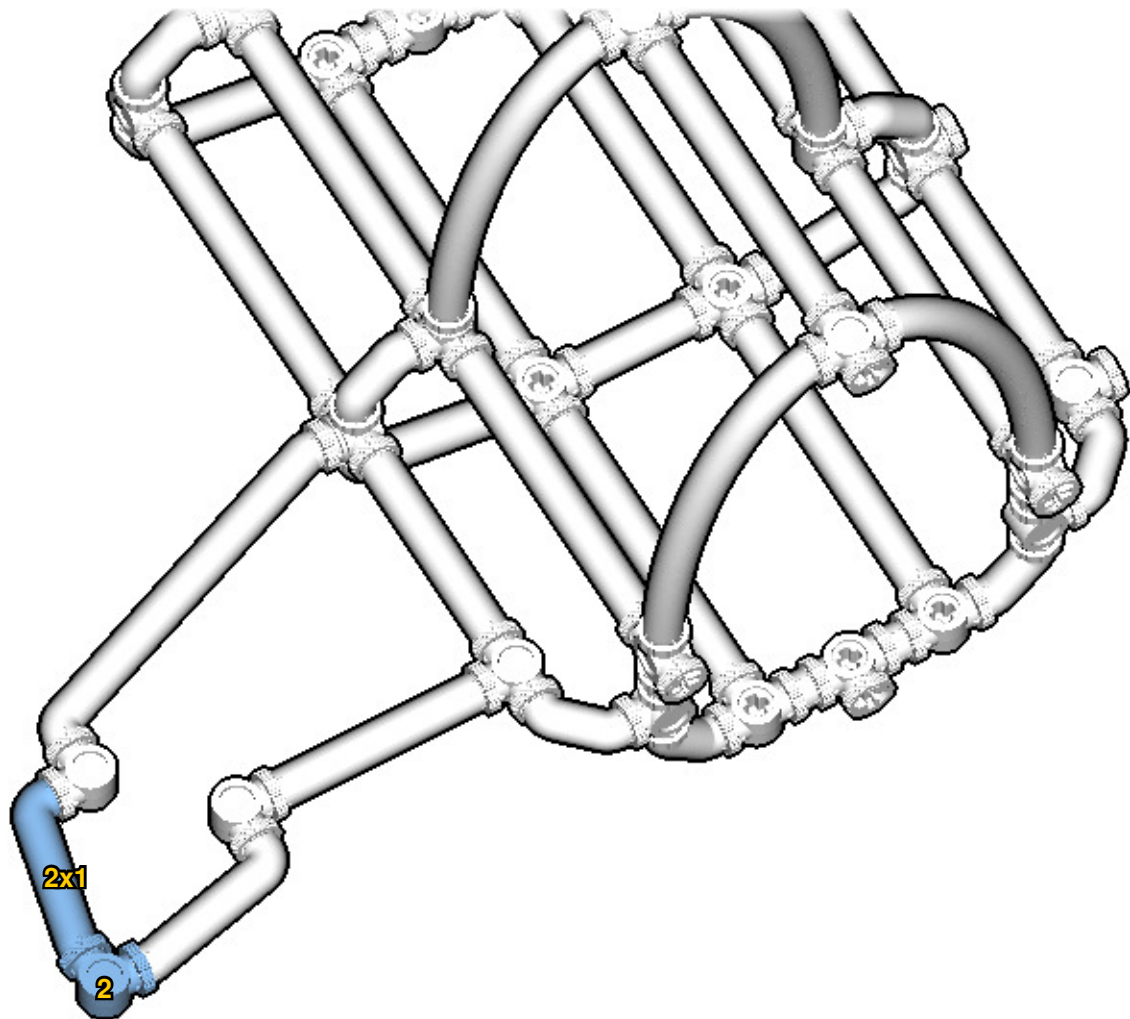

28

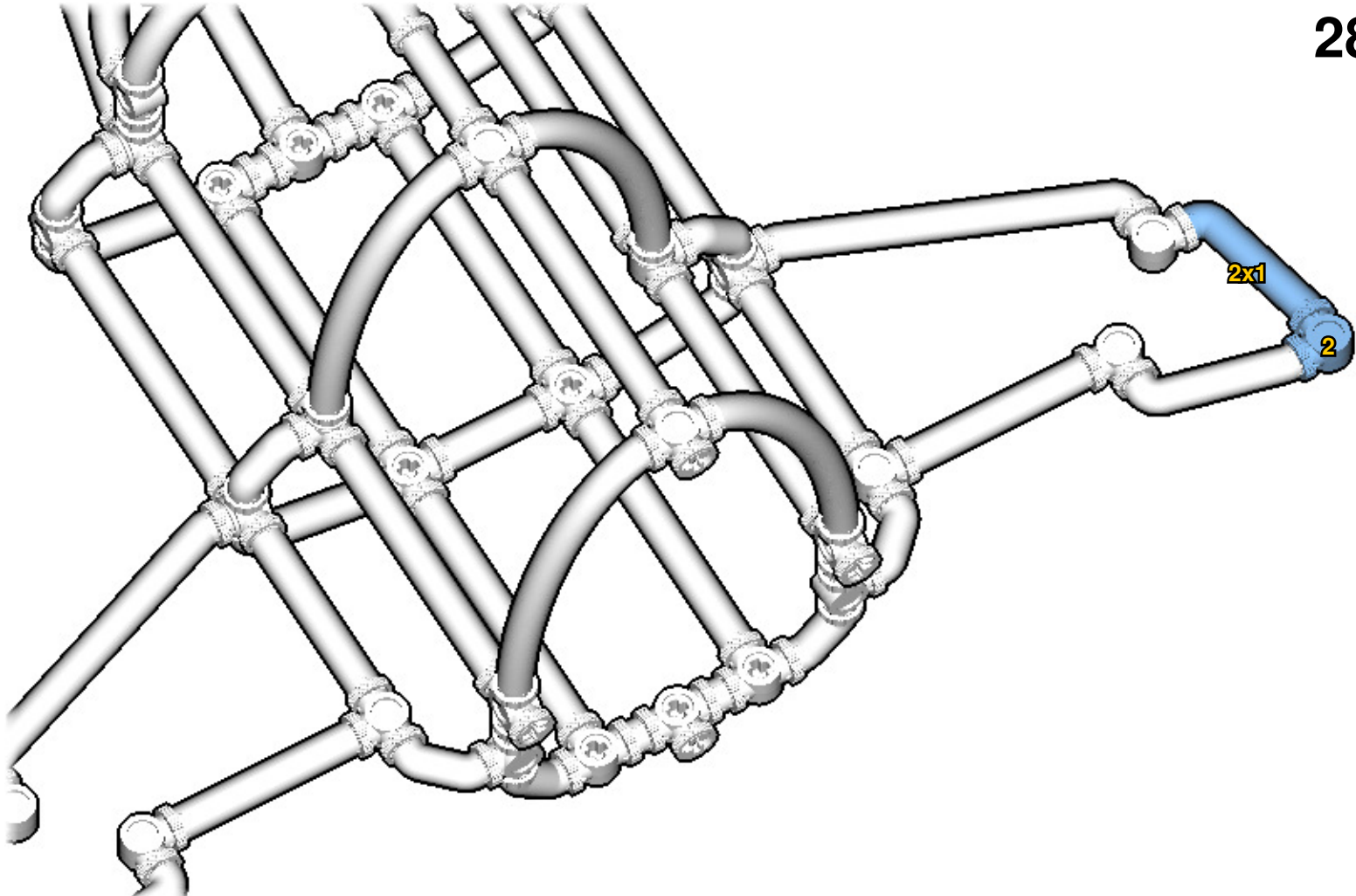

29

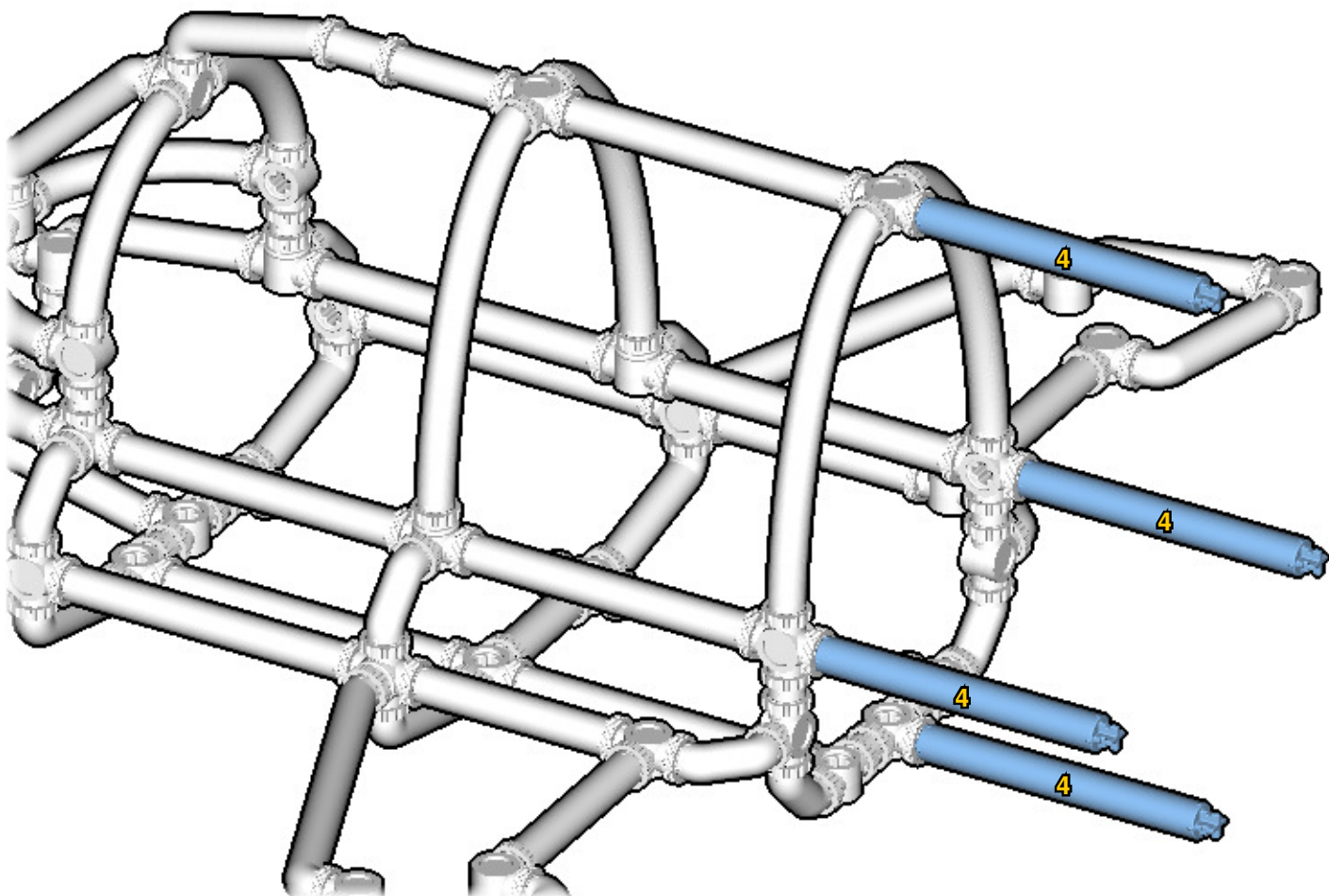

30

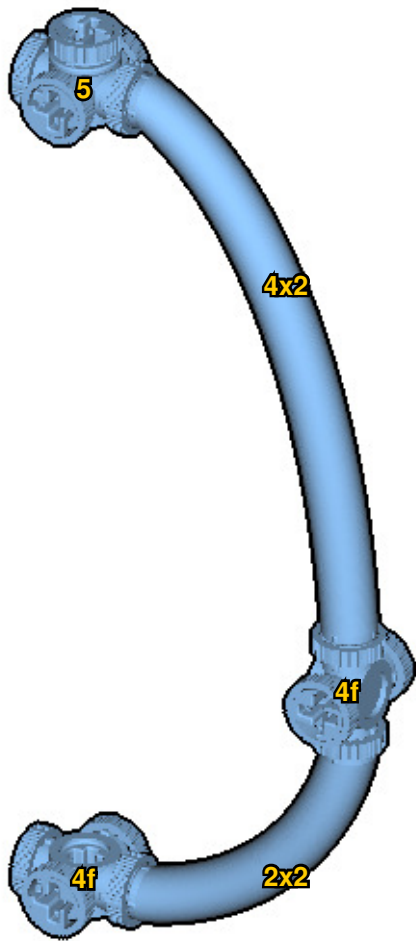

31

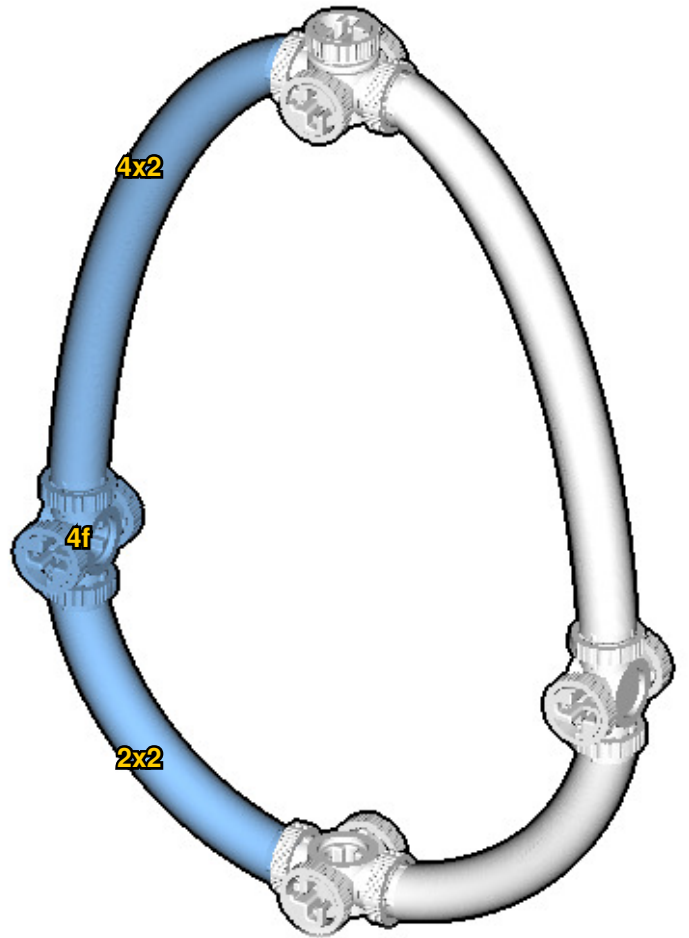

32

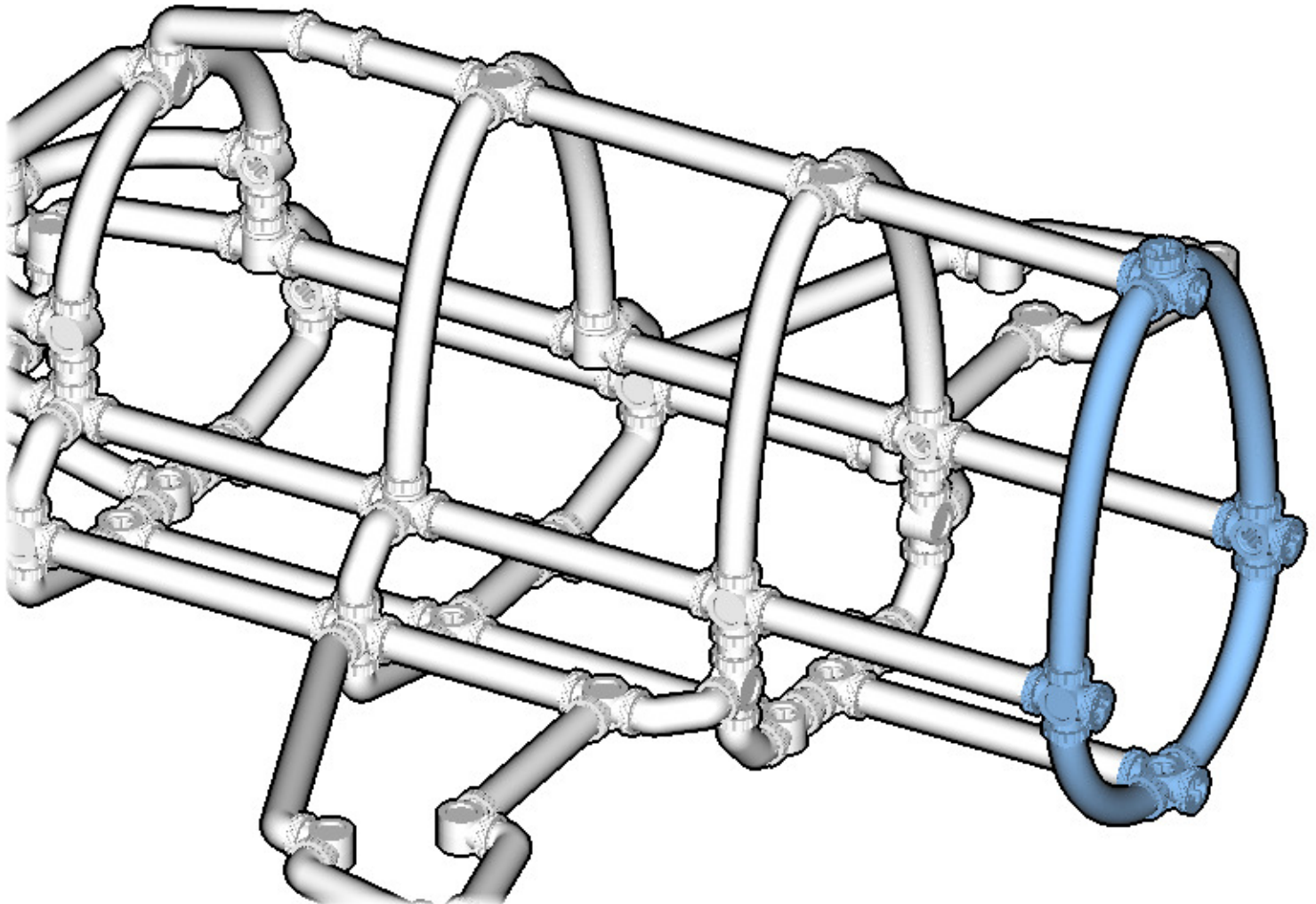

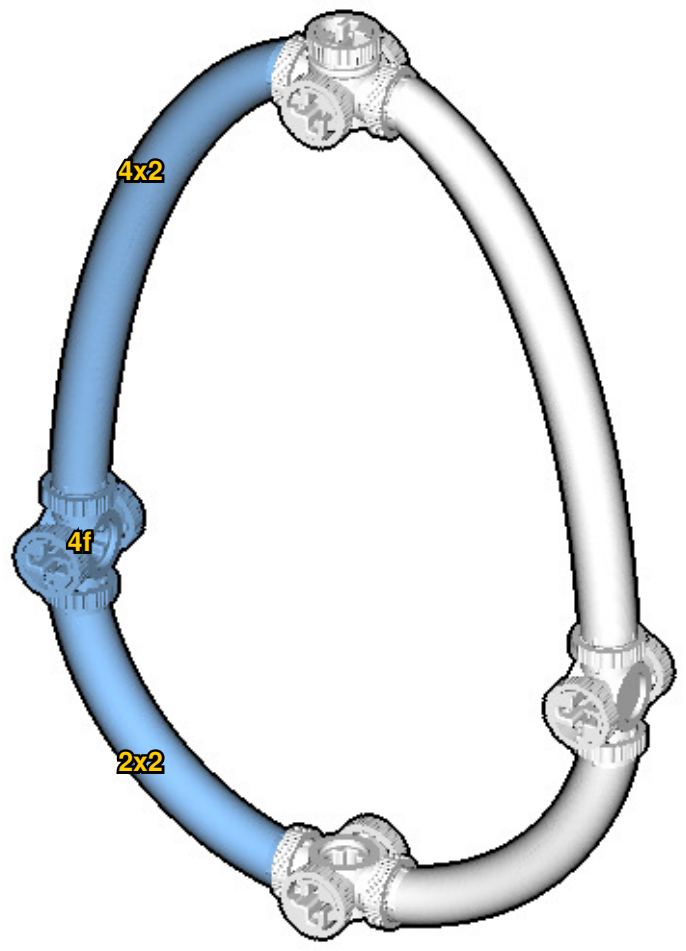
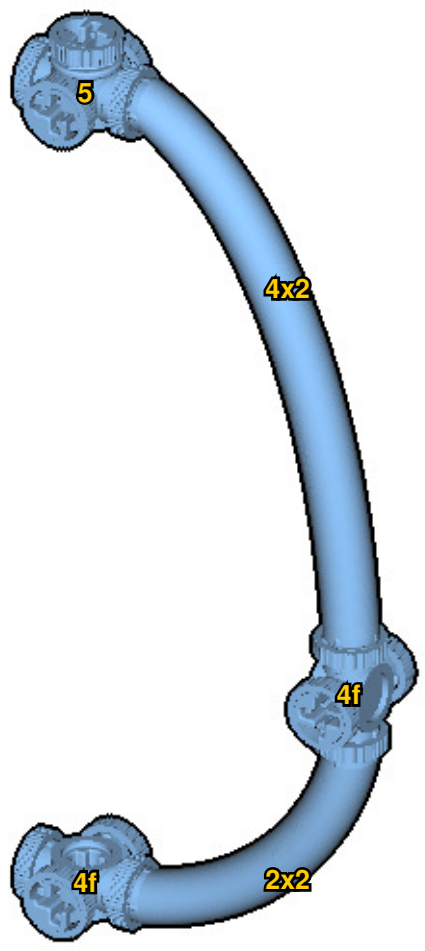
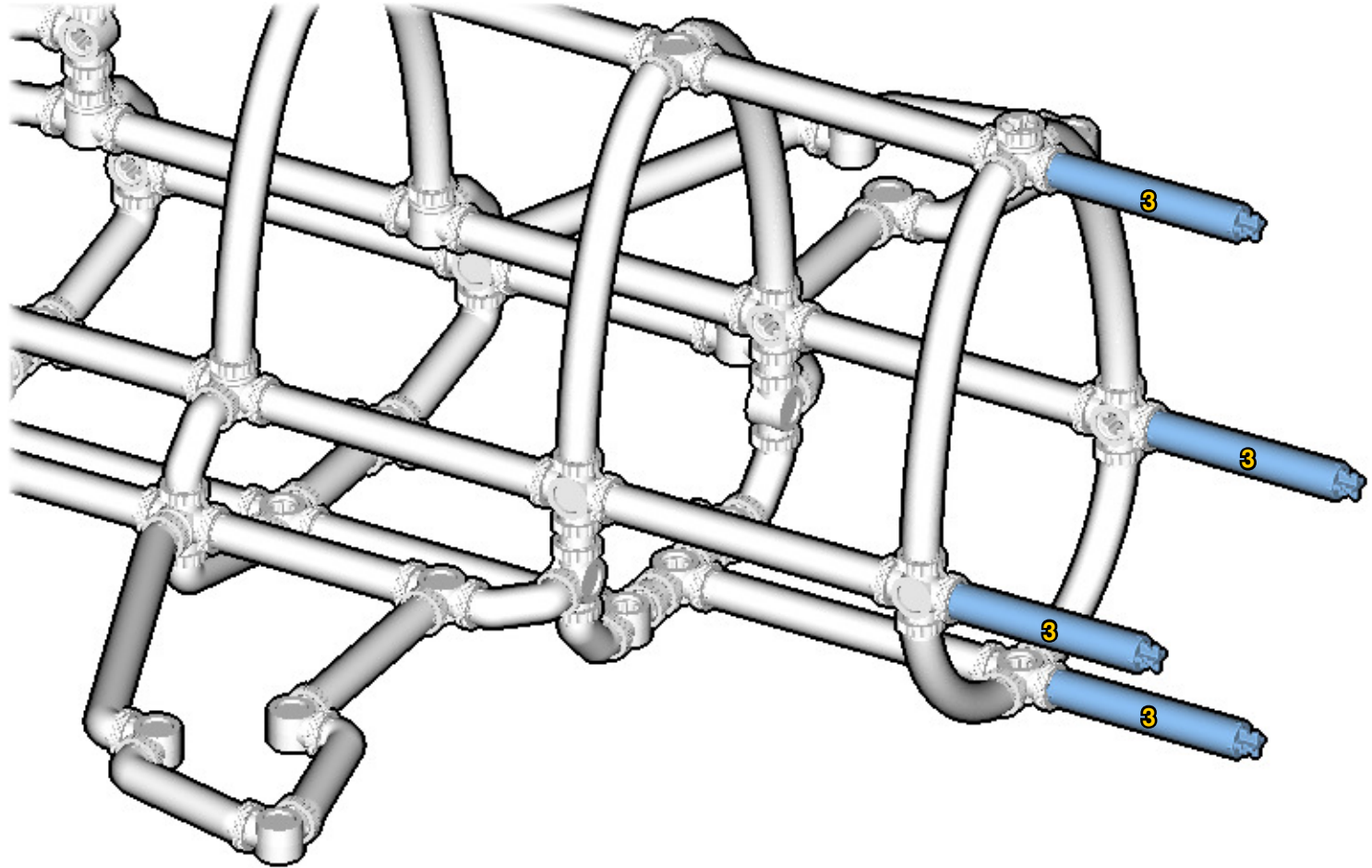

36

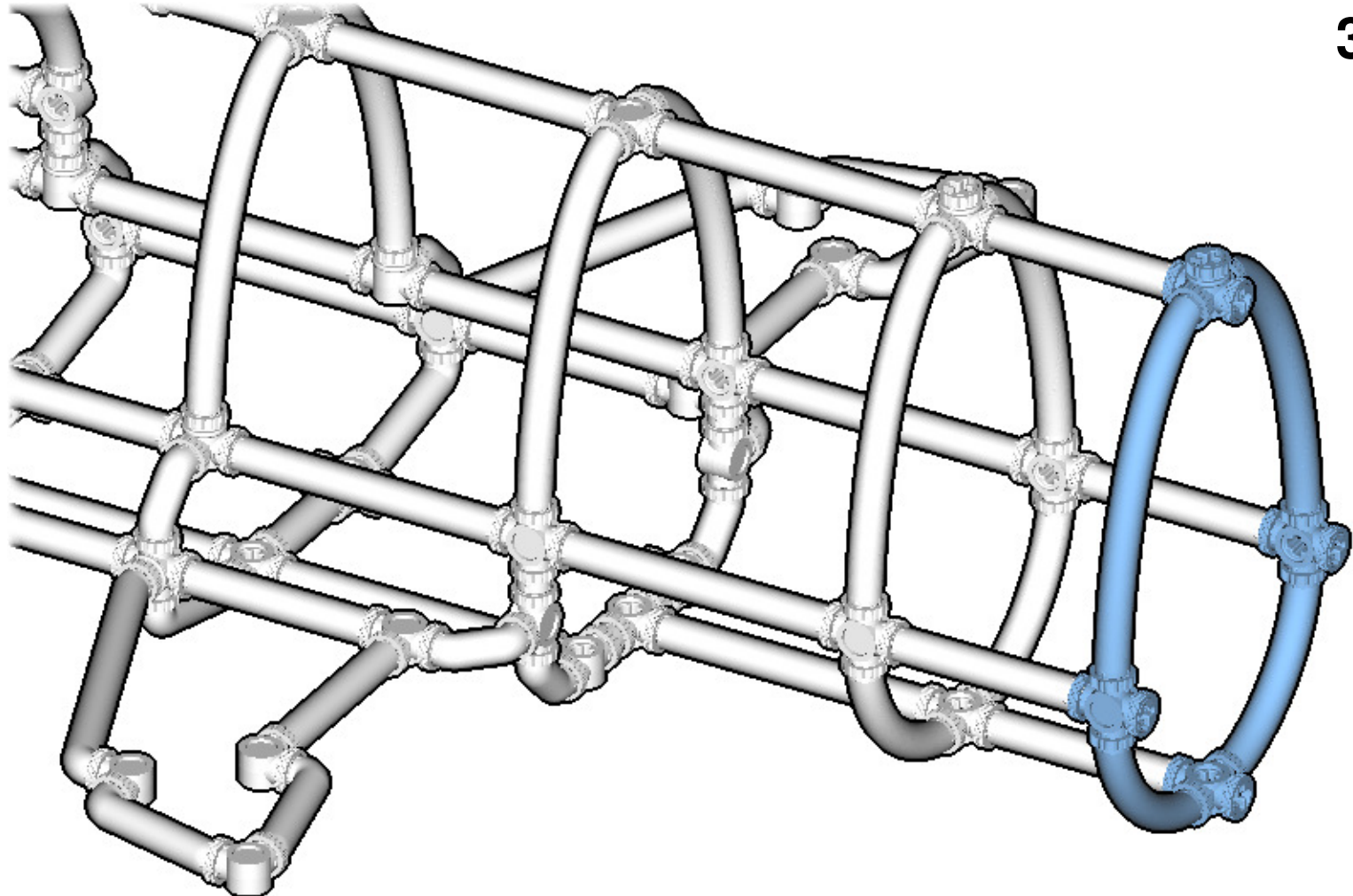

37

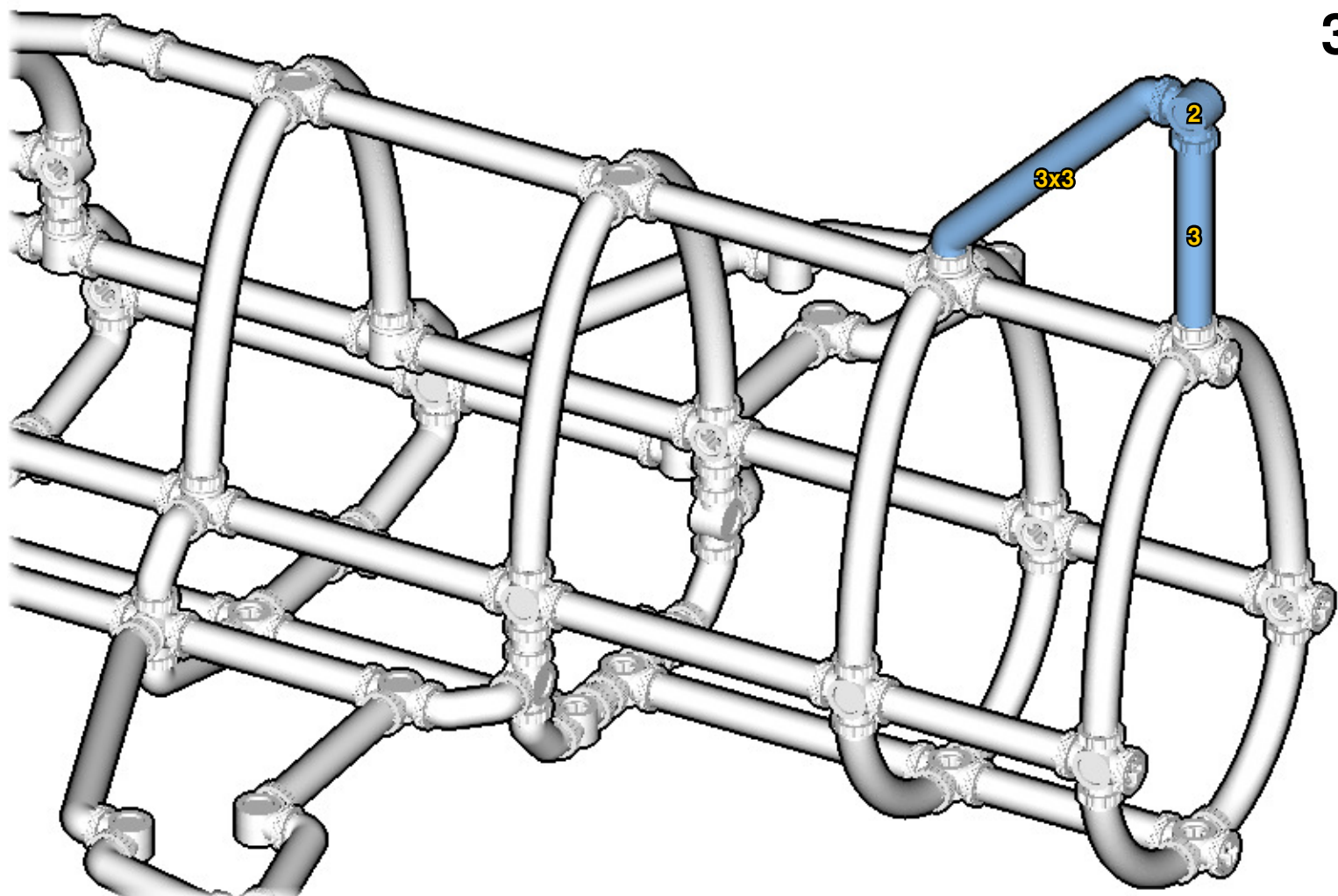

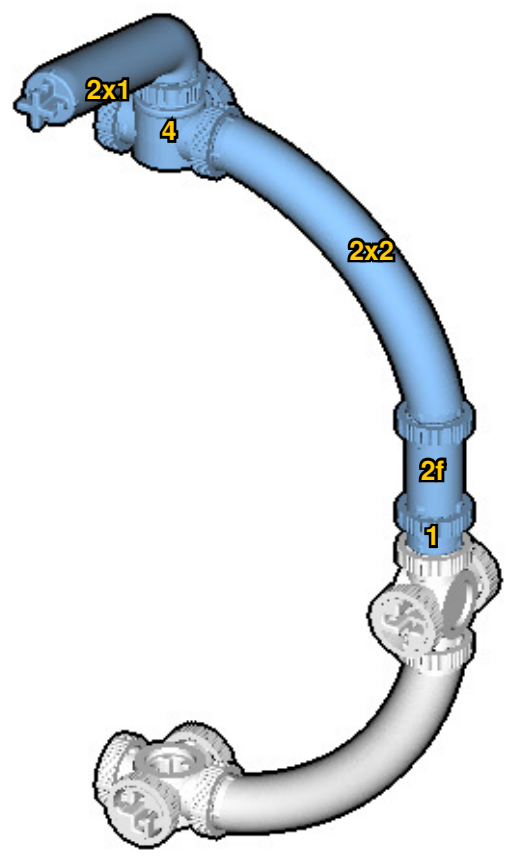
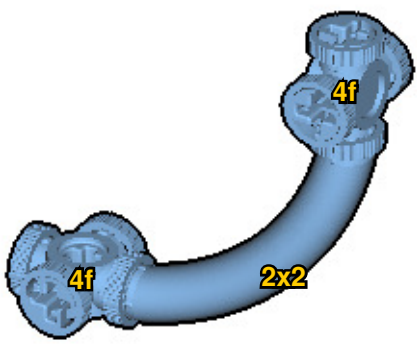
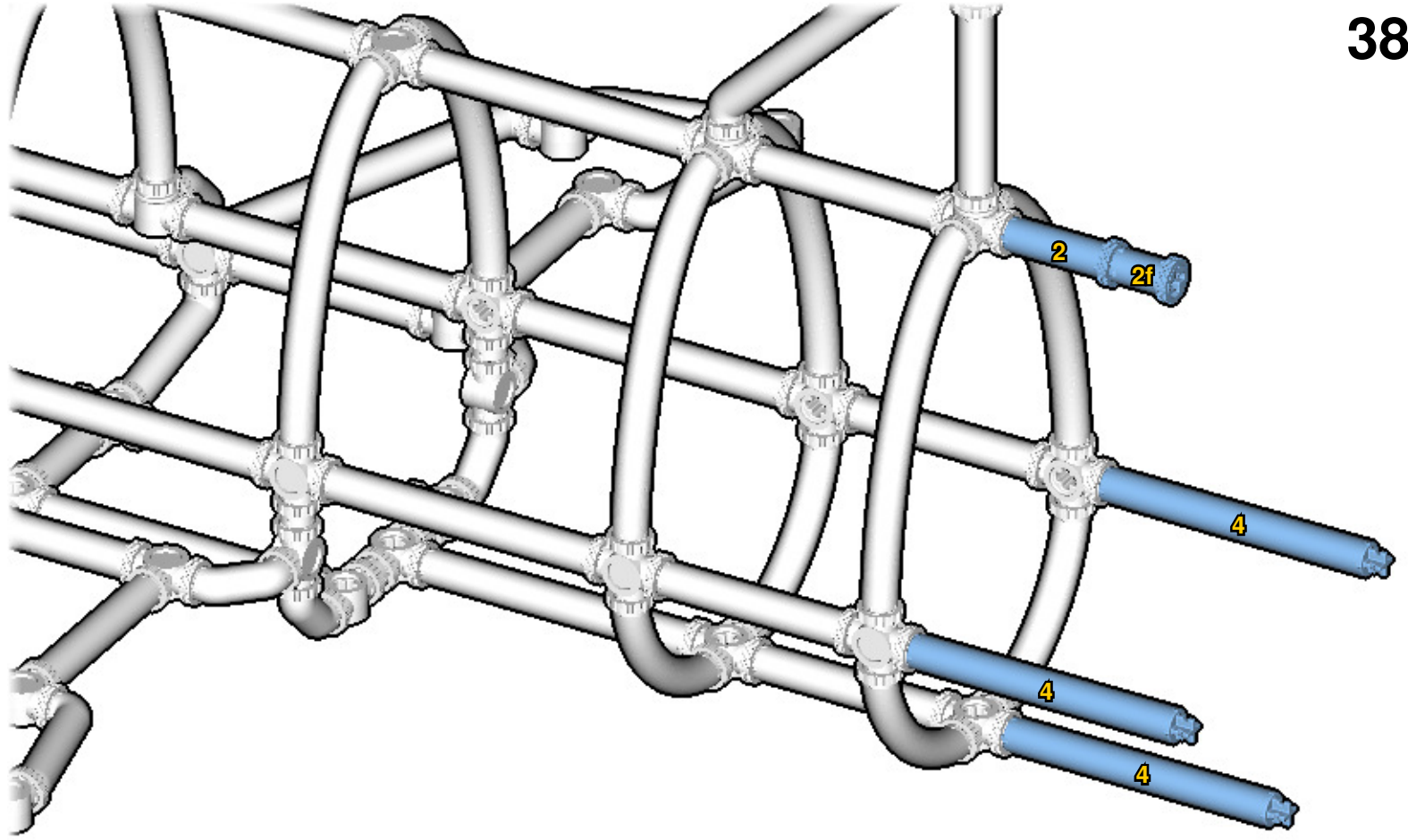

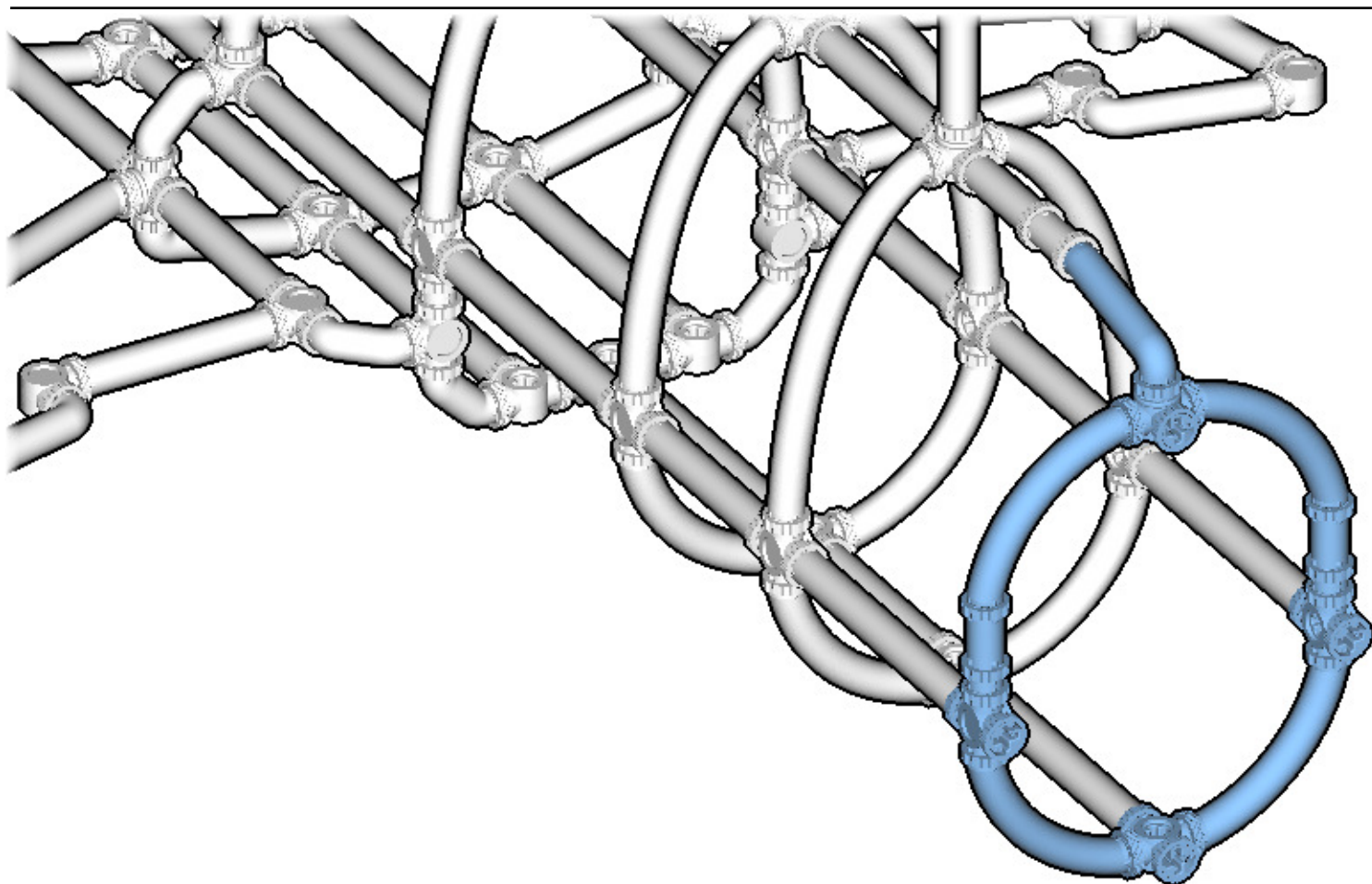
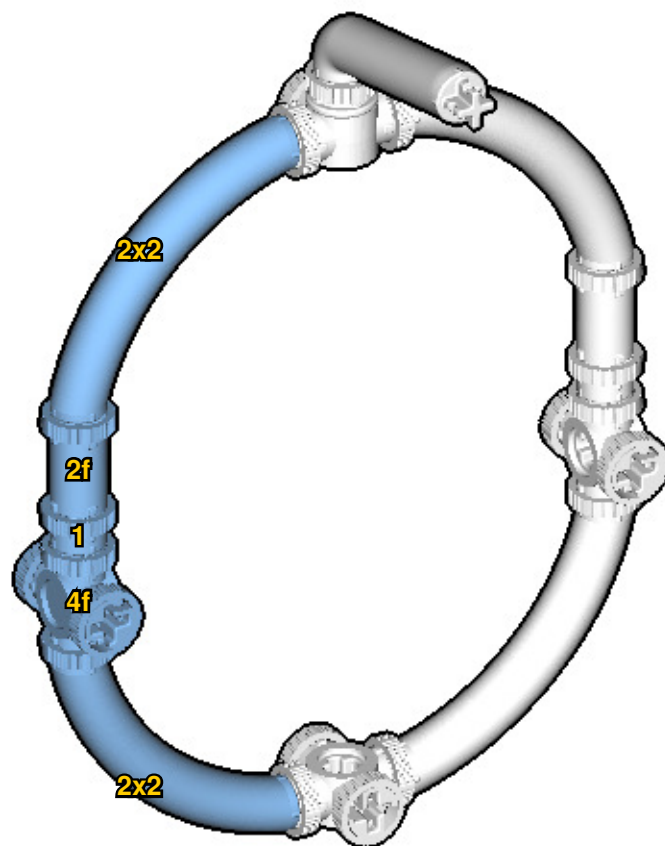

43

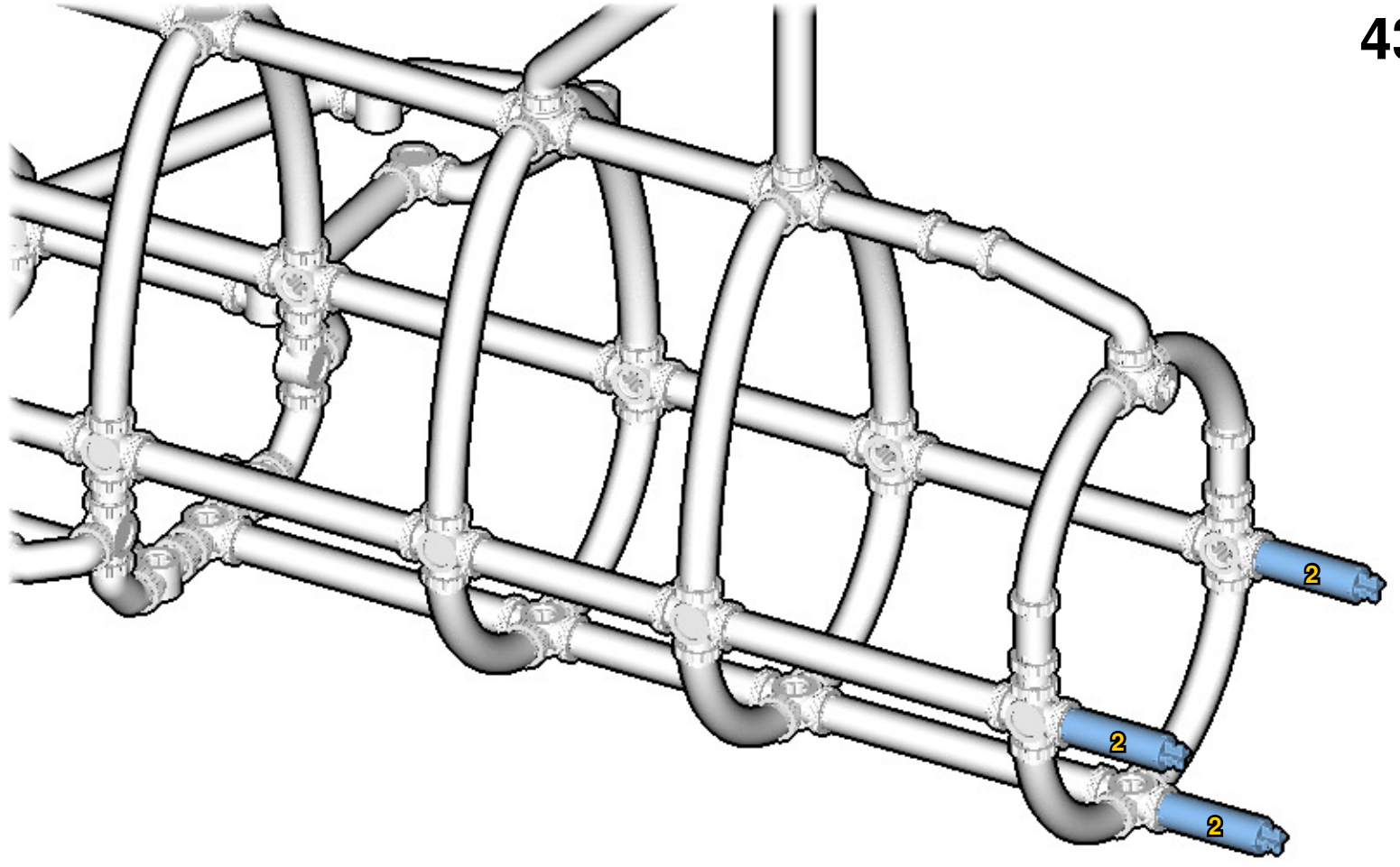

44

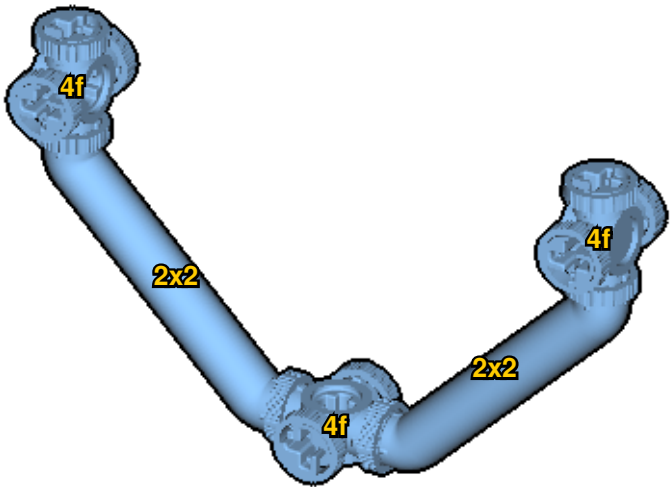

45

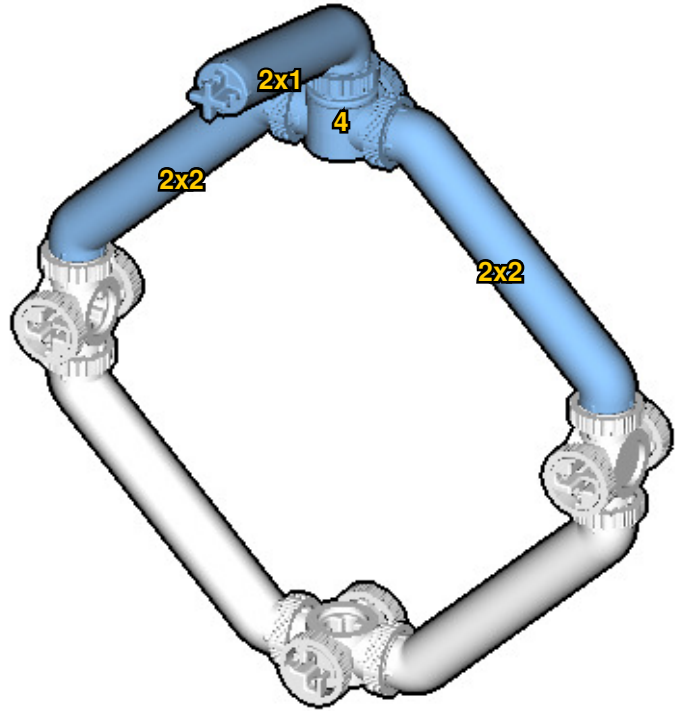

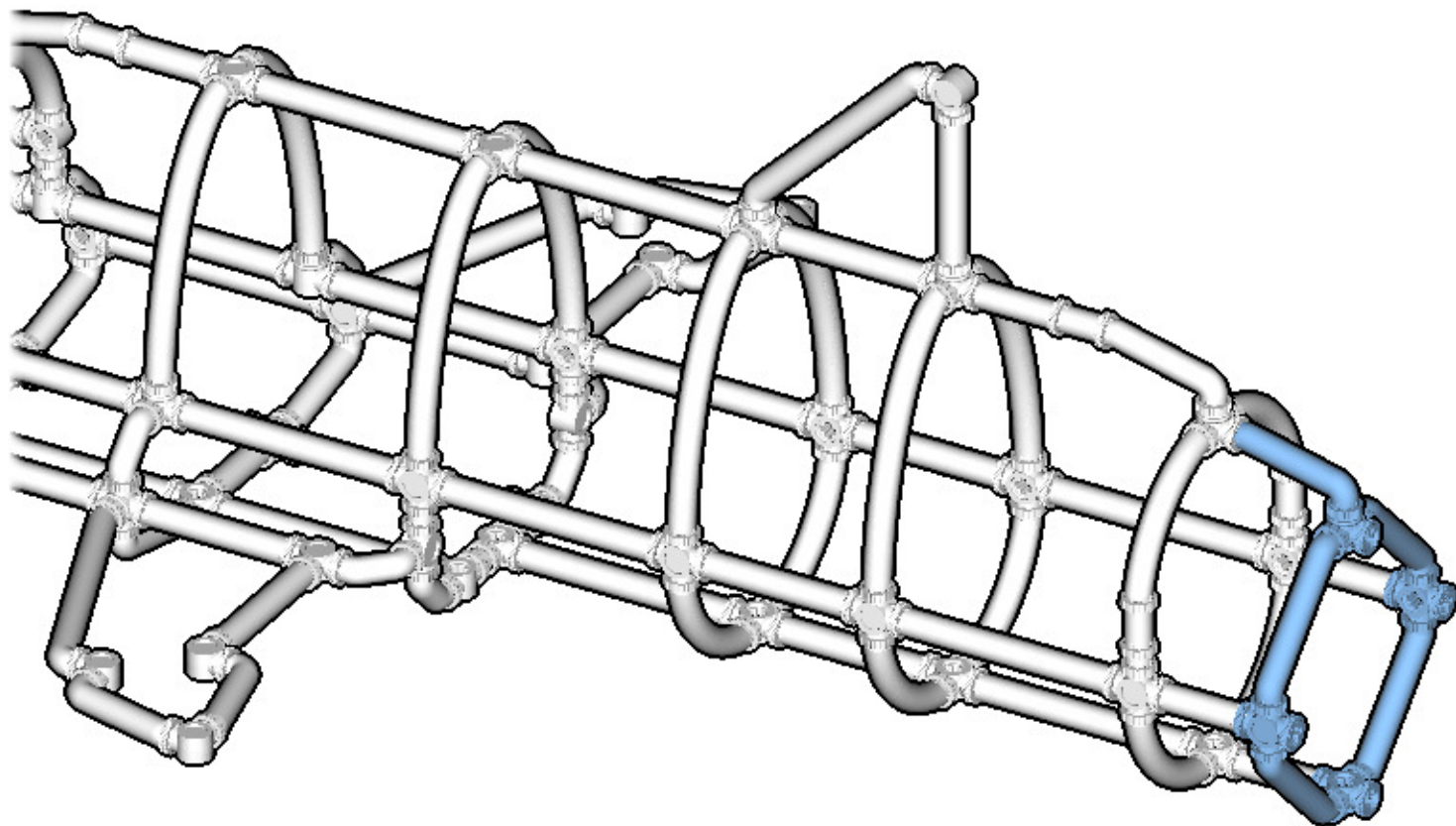
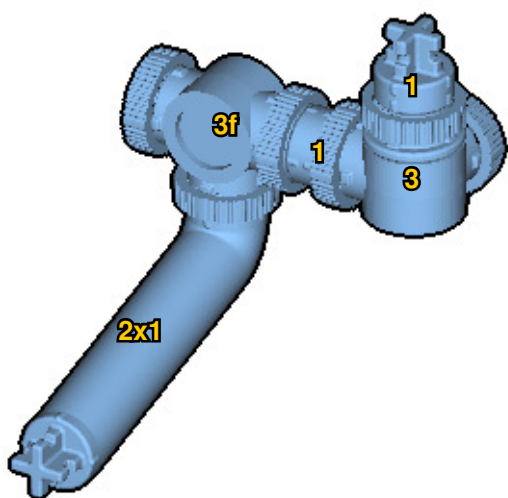
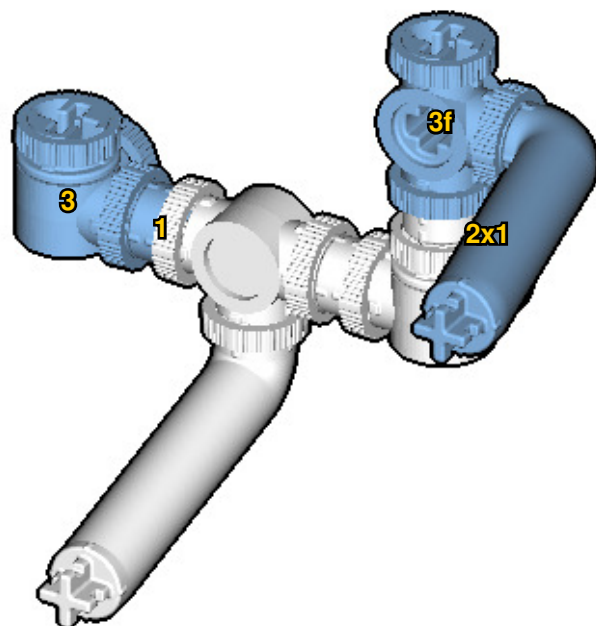
4748

49

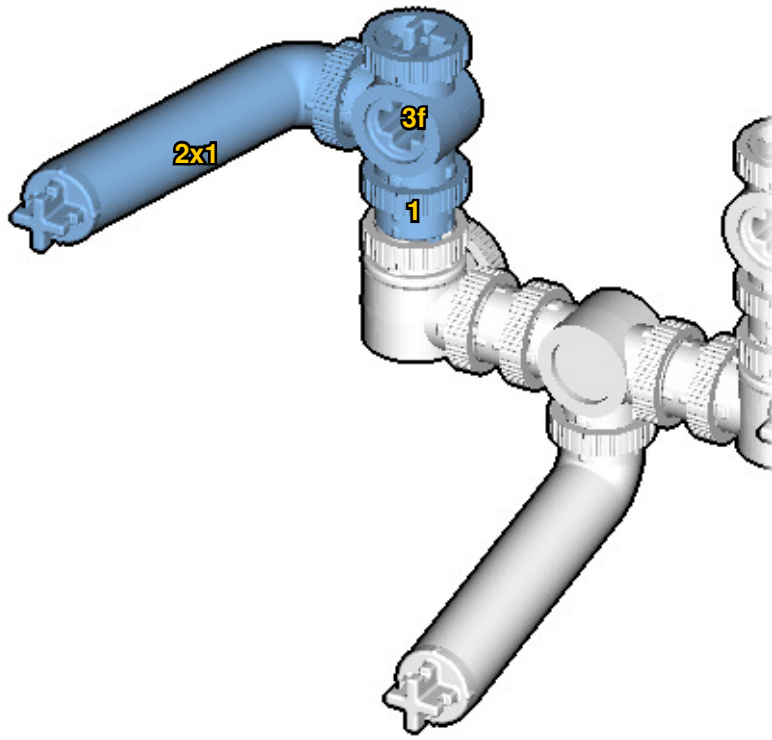

50

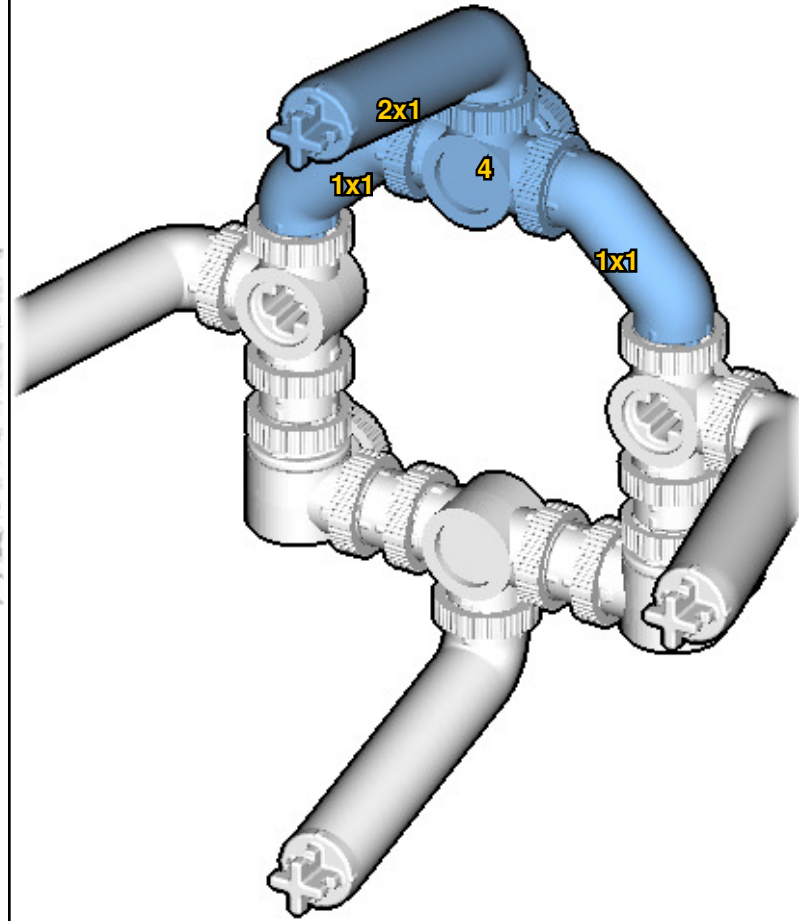

51

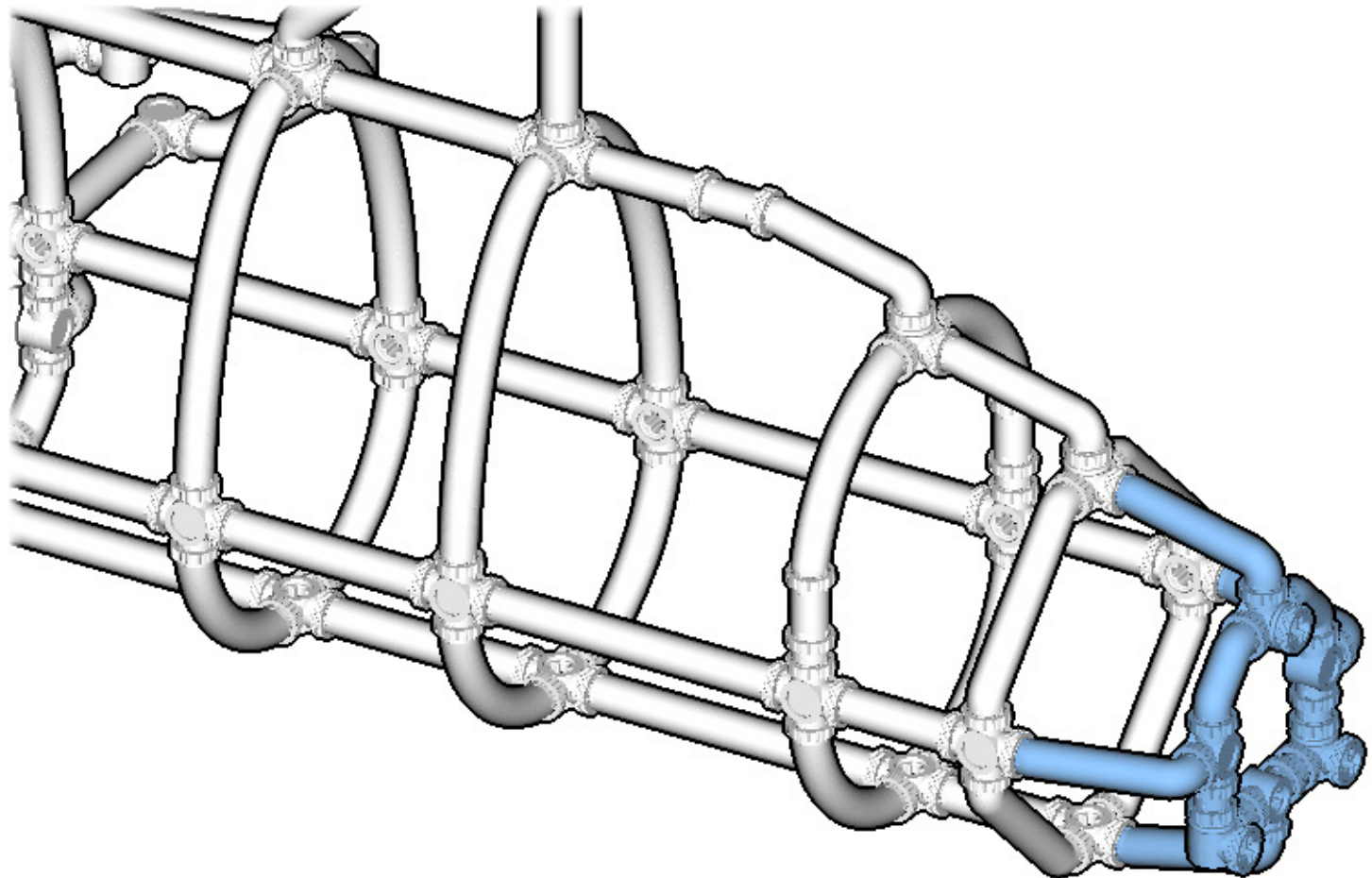

52

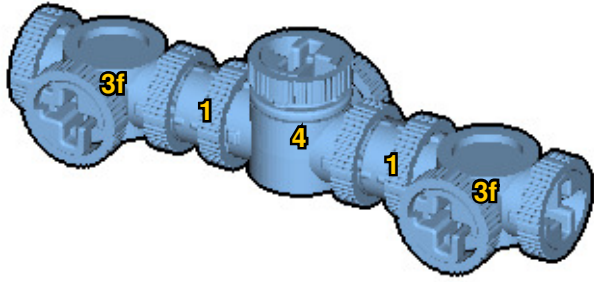

53

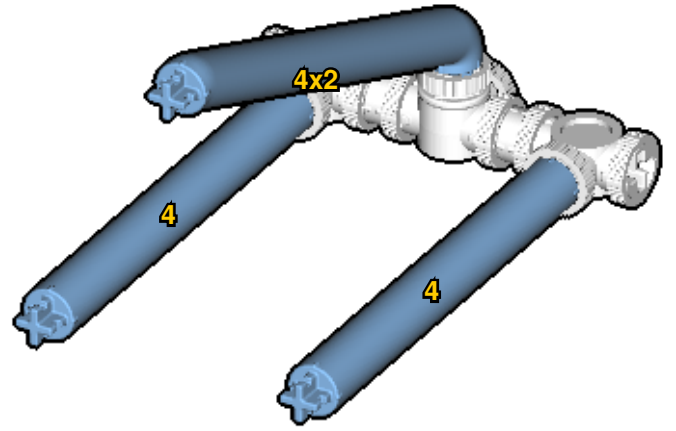

54

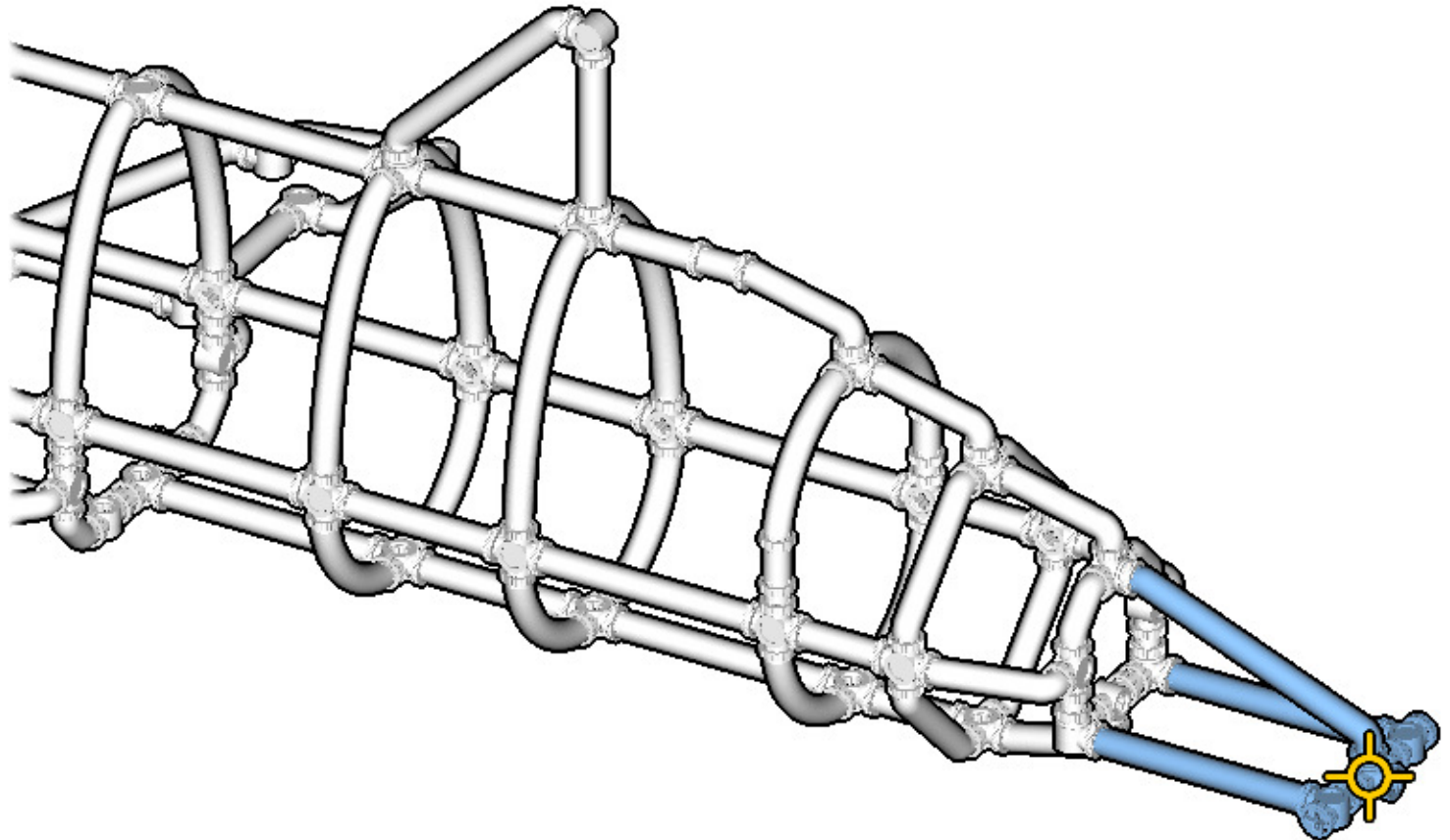

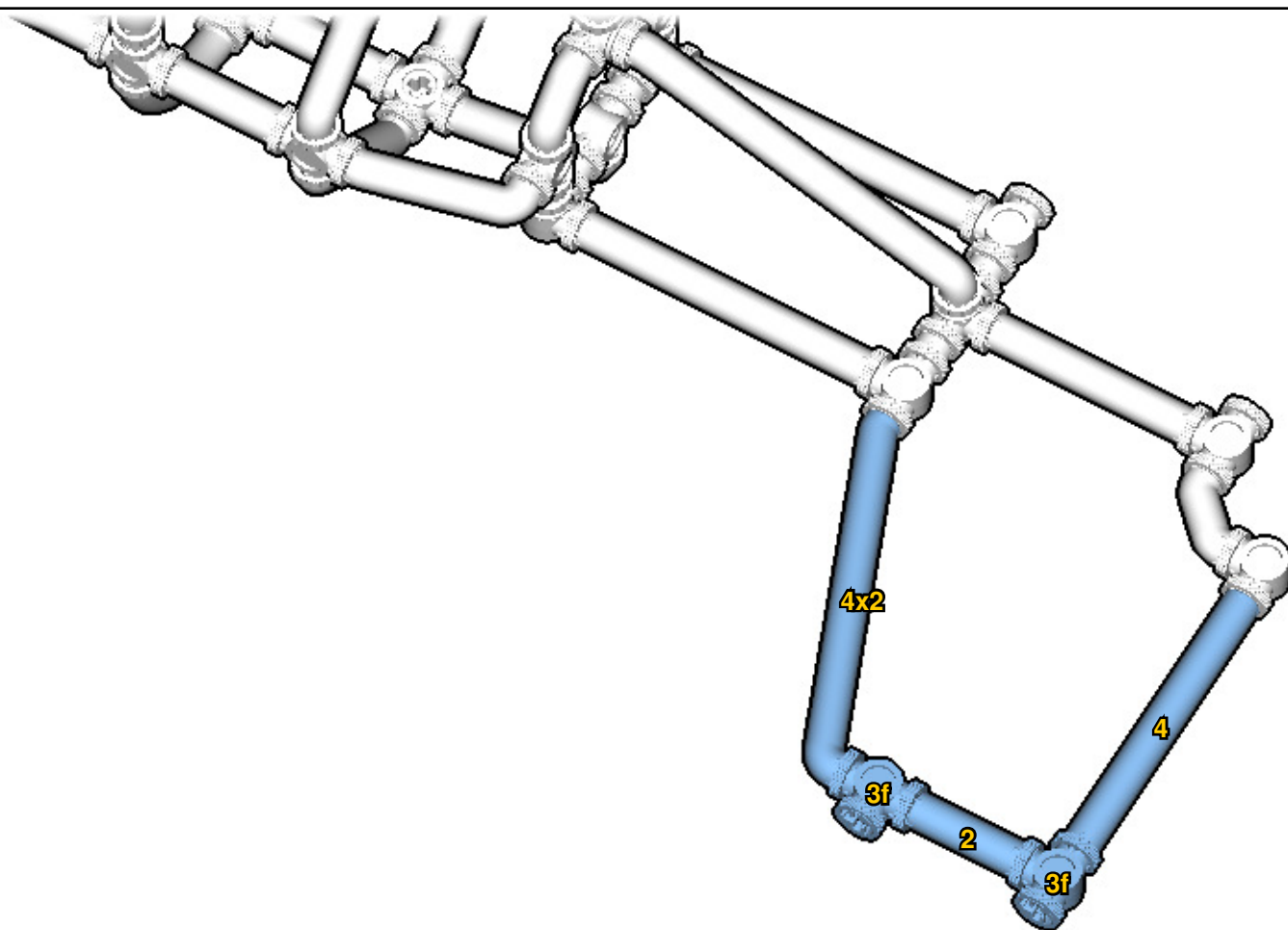
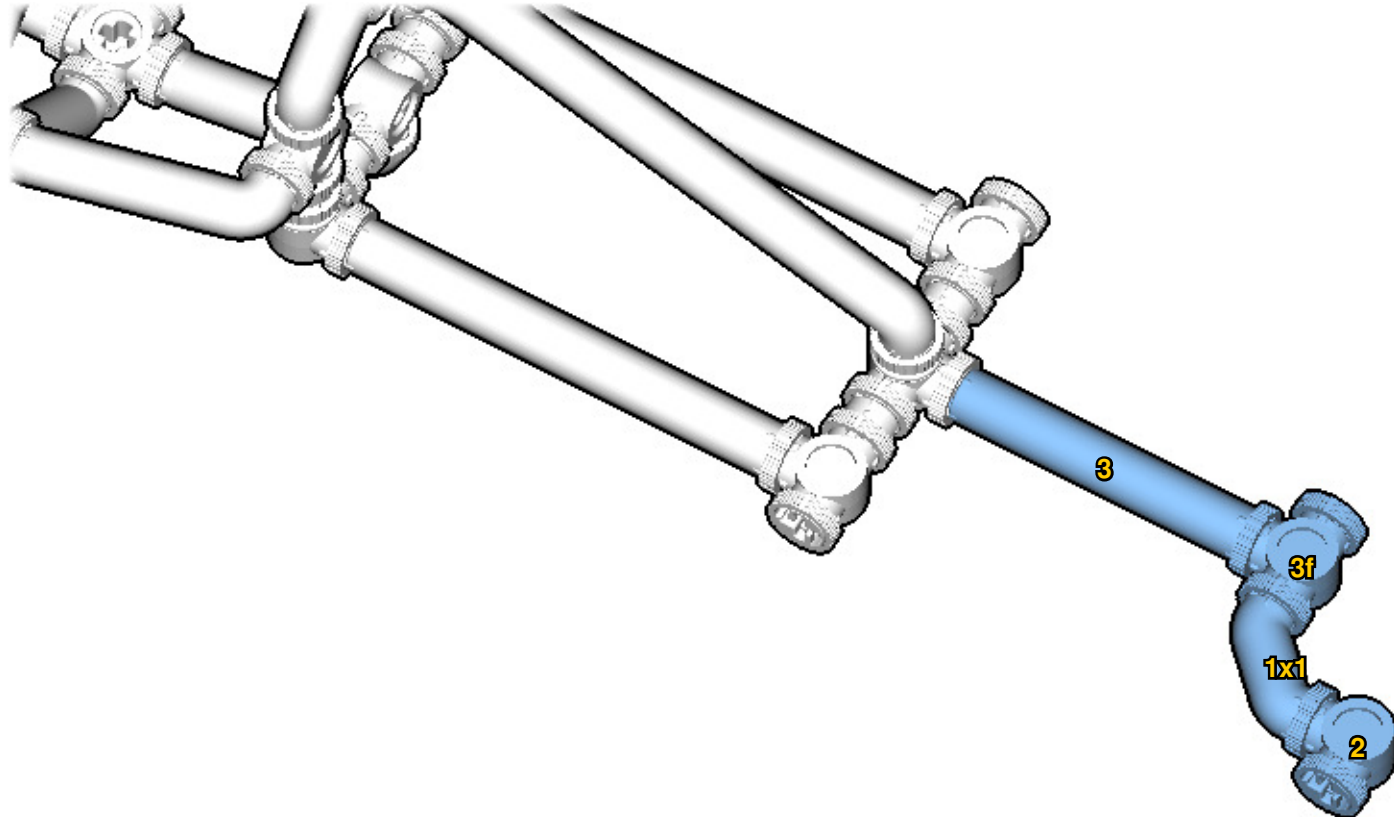

57

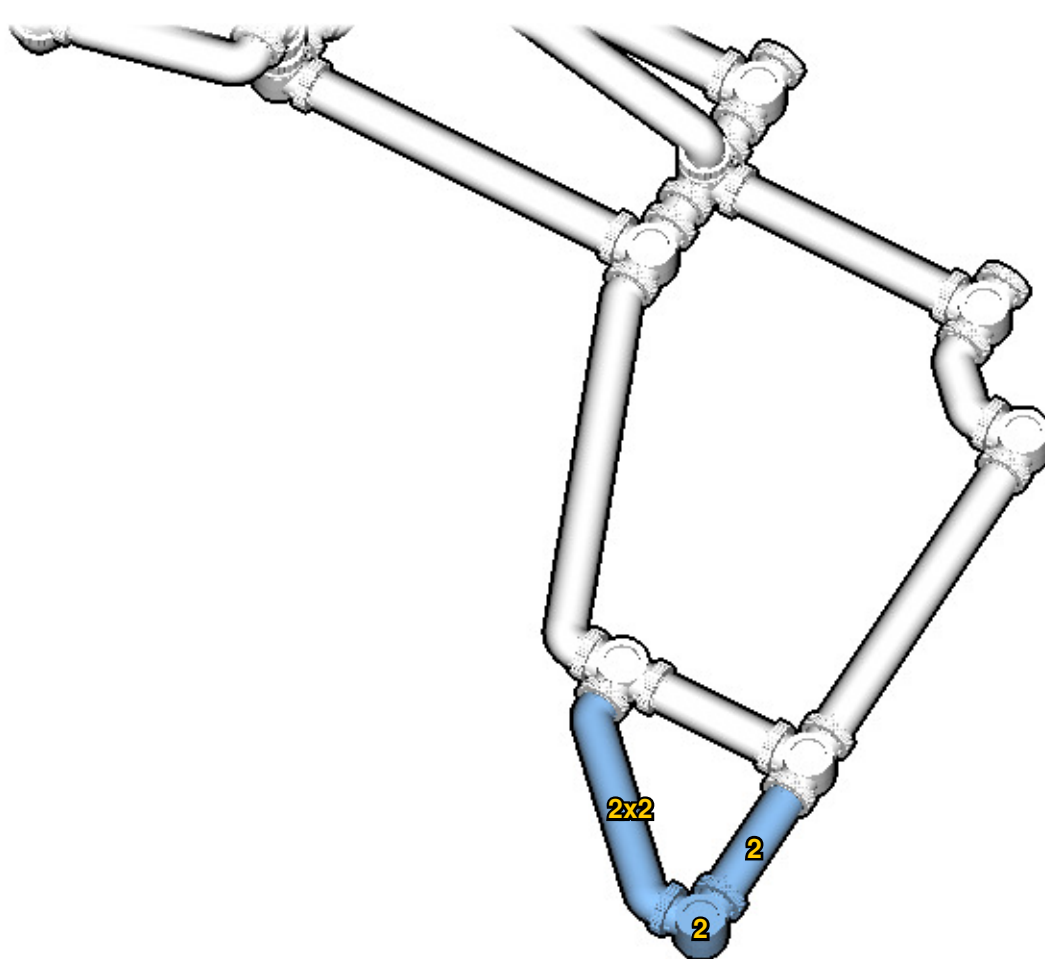

58

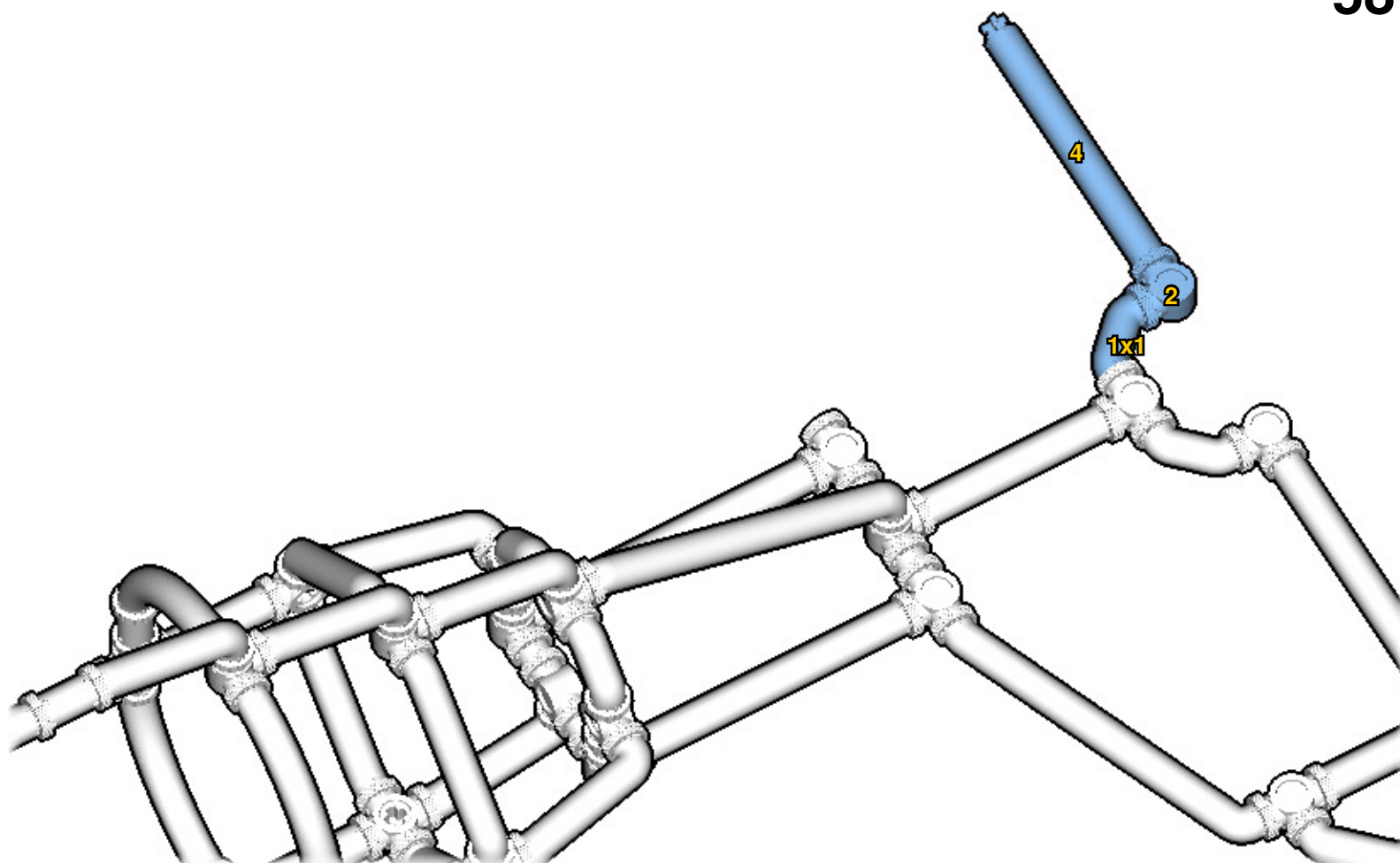

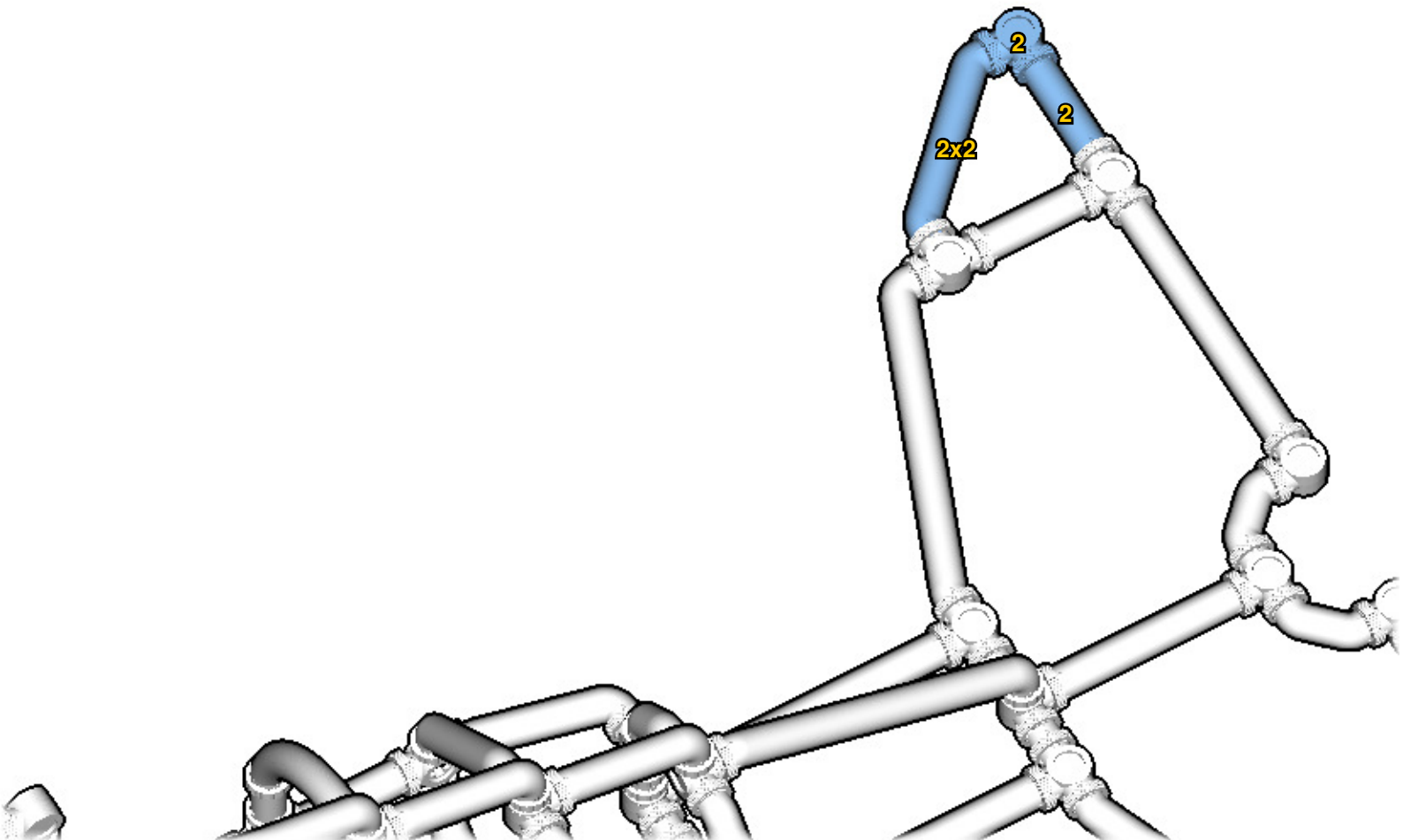
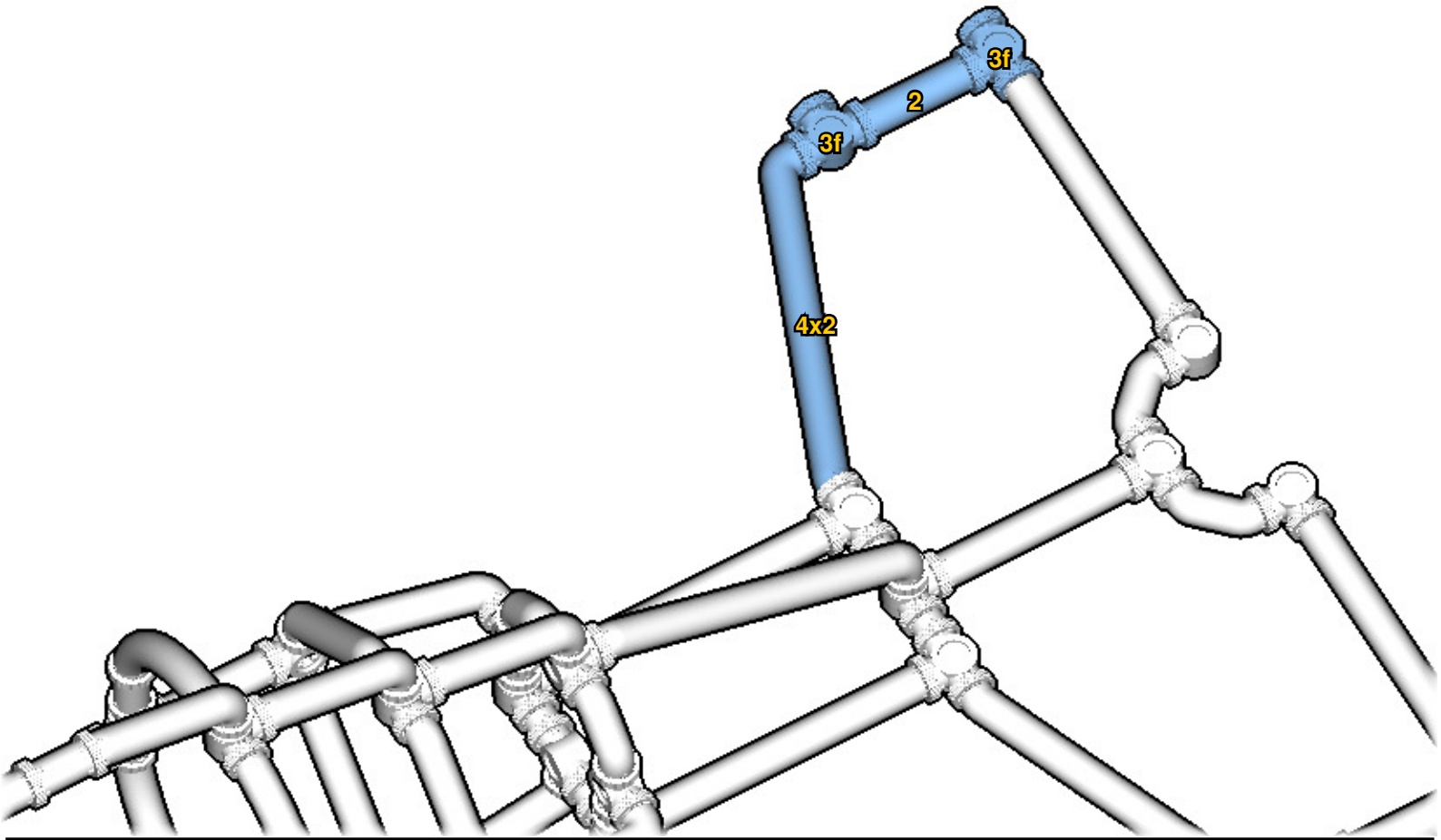

INVENTORY

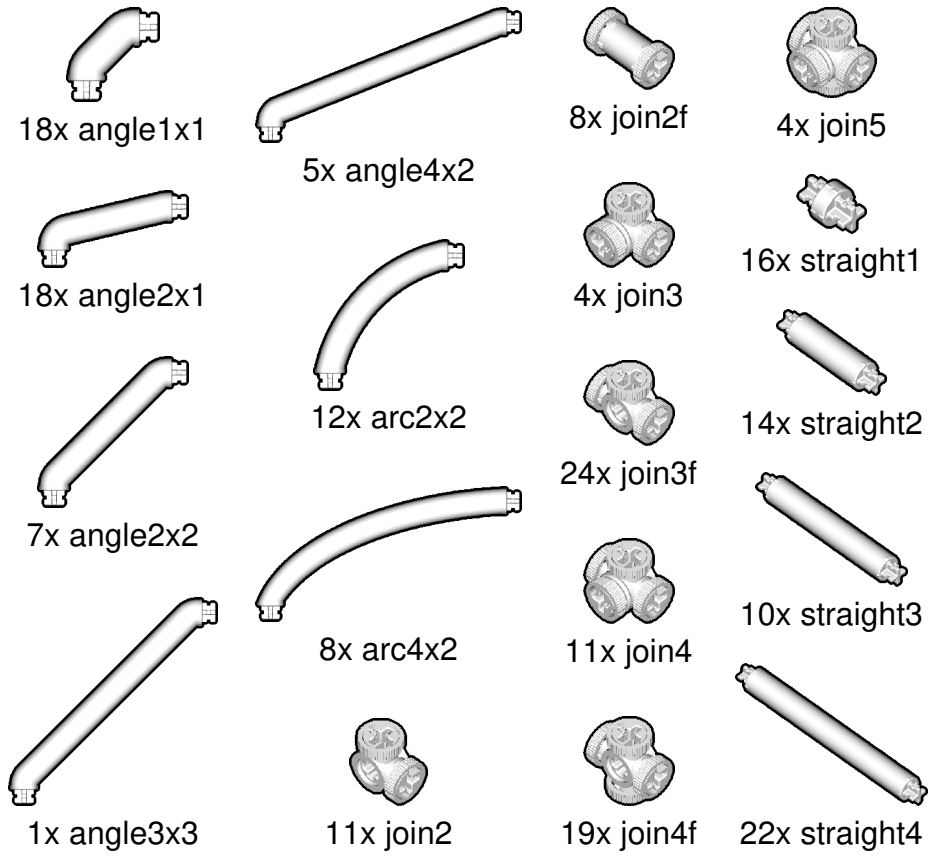

ACTUAL SIZE

