

SIZE	2.7ft x 1.2ft x 0.7ft	PIECES	308
DESIGNER	Charles Sharman	MADE IN	U.S.A.

DOLPHIN

⚠ WARNING: Small parts. Age 14+. Not a toy. Handle responsibly. U.S. Patent 9,086,087.



Wrong
Connecting/Disconnecting Two Directions



Right
Connecting/Disconnecting One Direction

1

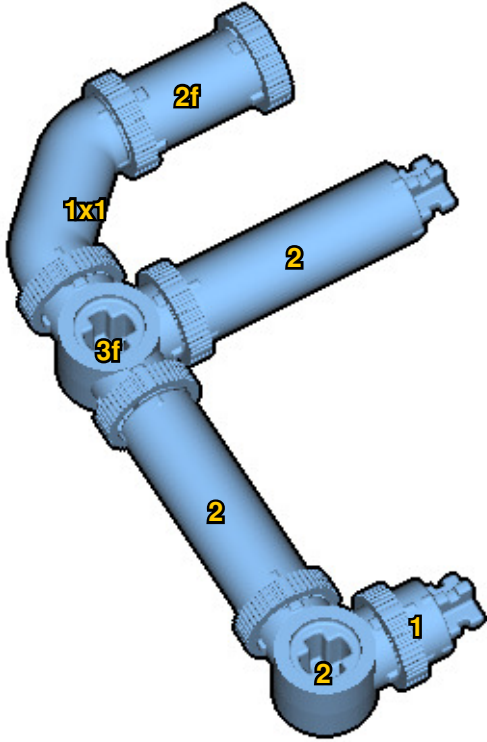

New pieces are drawn blue. Old pieces are drawn white.
See back for piece names.

2

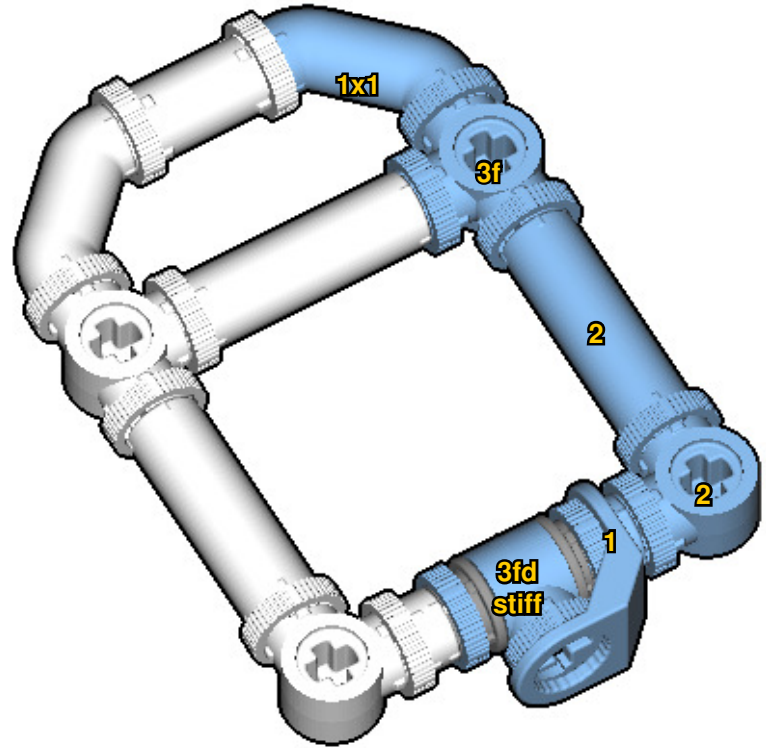

Connect new pieces together before connecting to old pieces.

3

couple axle_g1 axle_g1

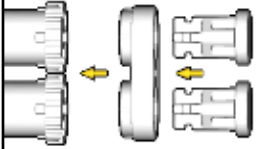

Slide two axle_g1 through couple and join.

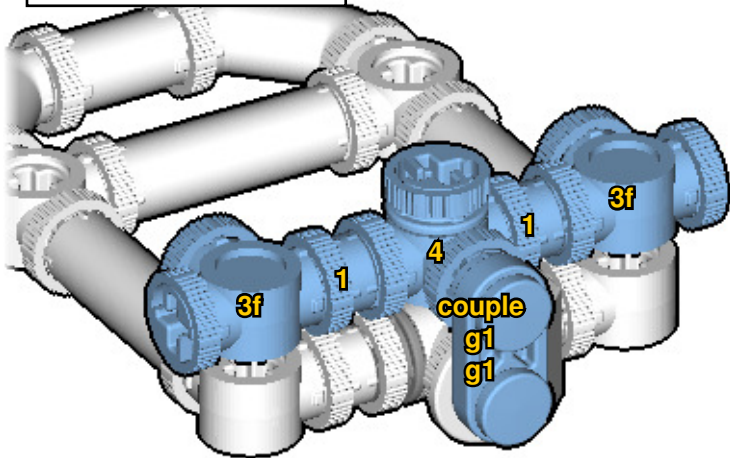

4

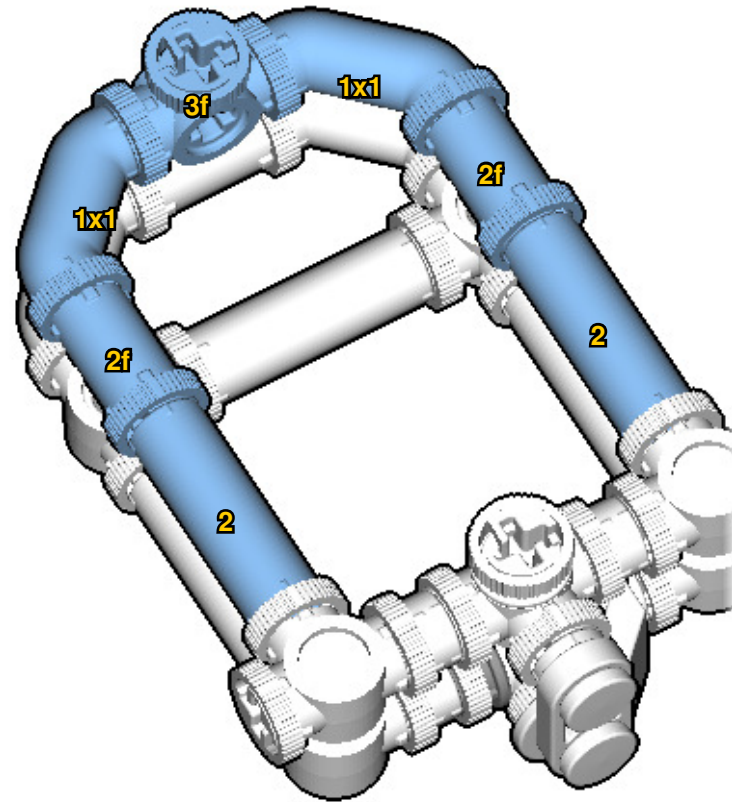

5

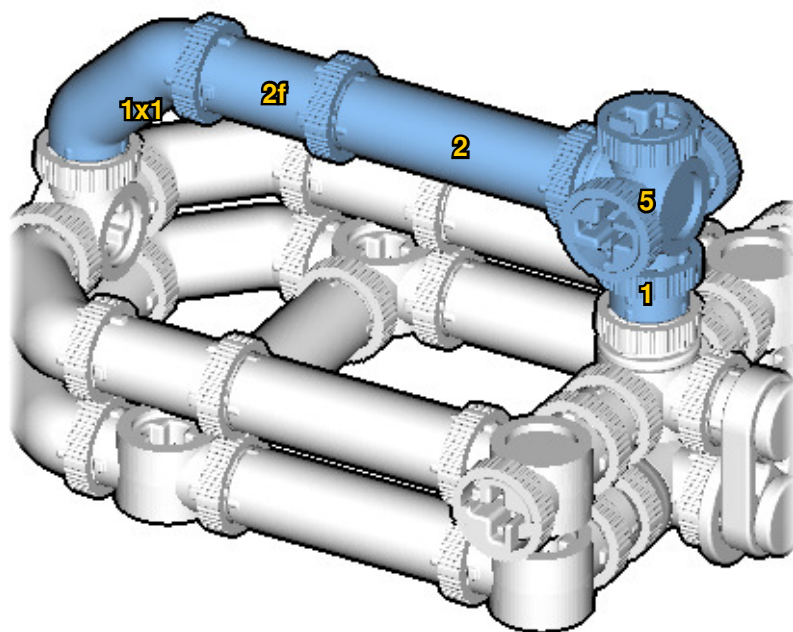

6

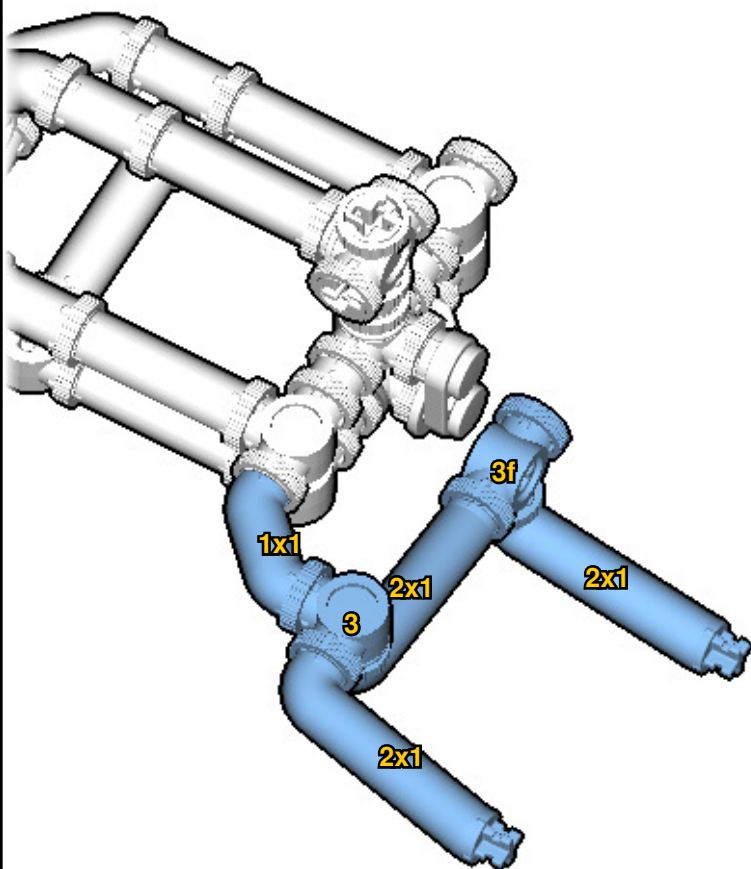

7

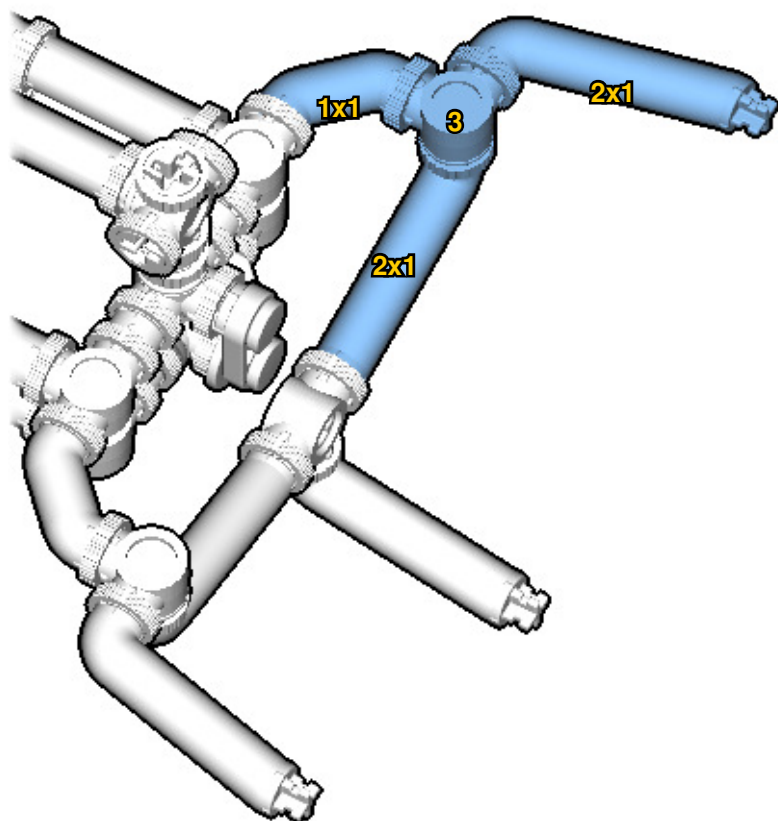

8

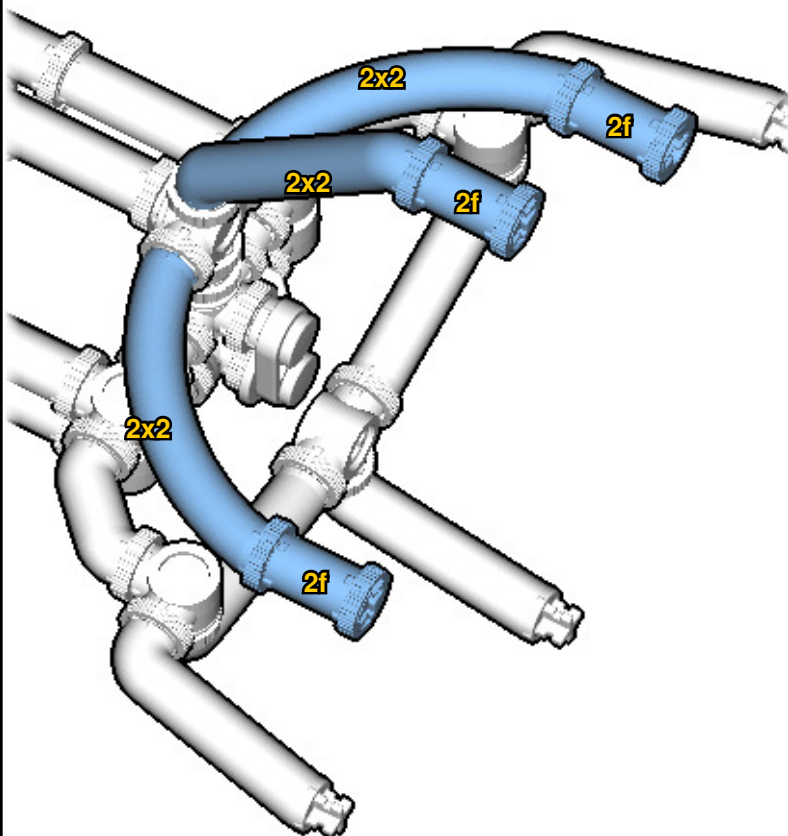

Submodel ends →

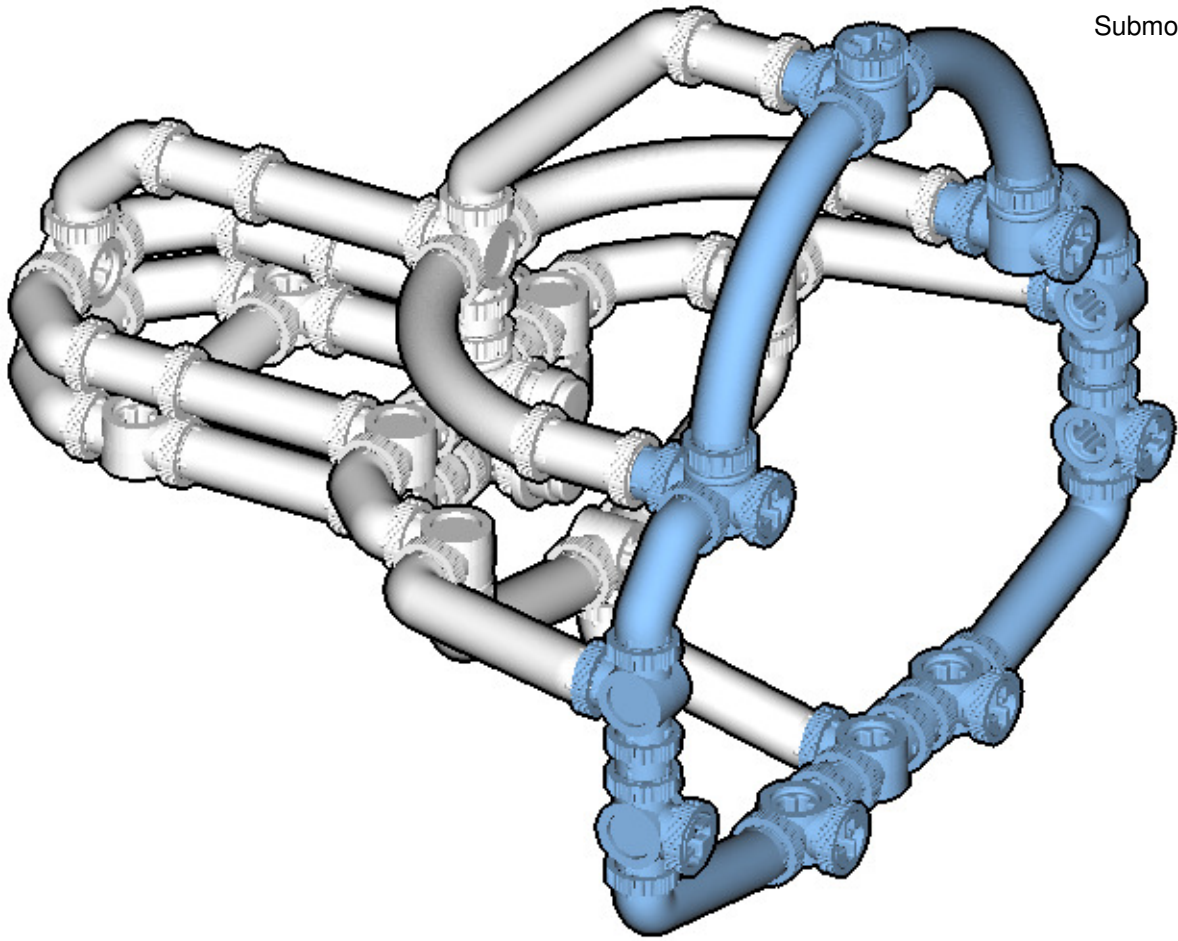

Connect submodel to model.

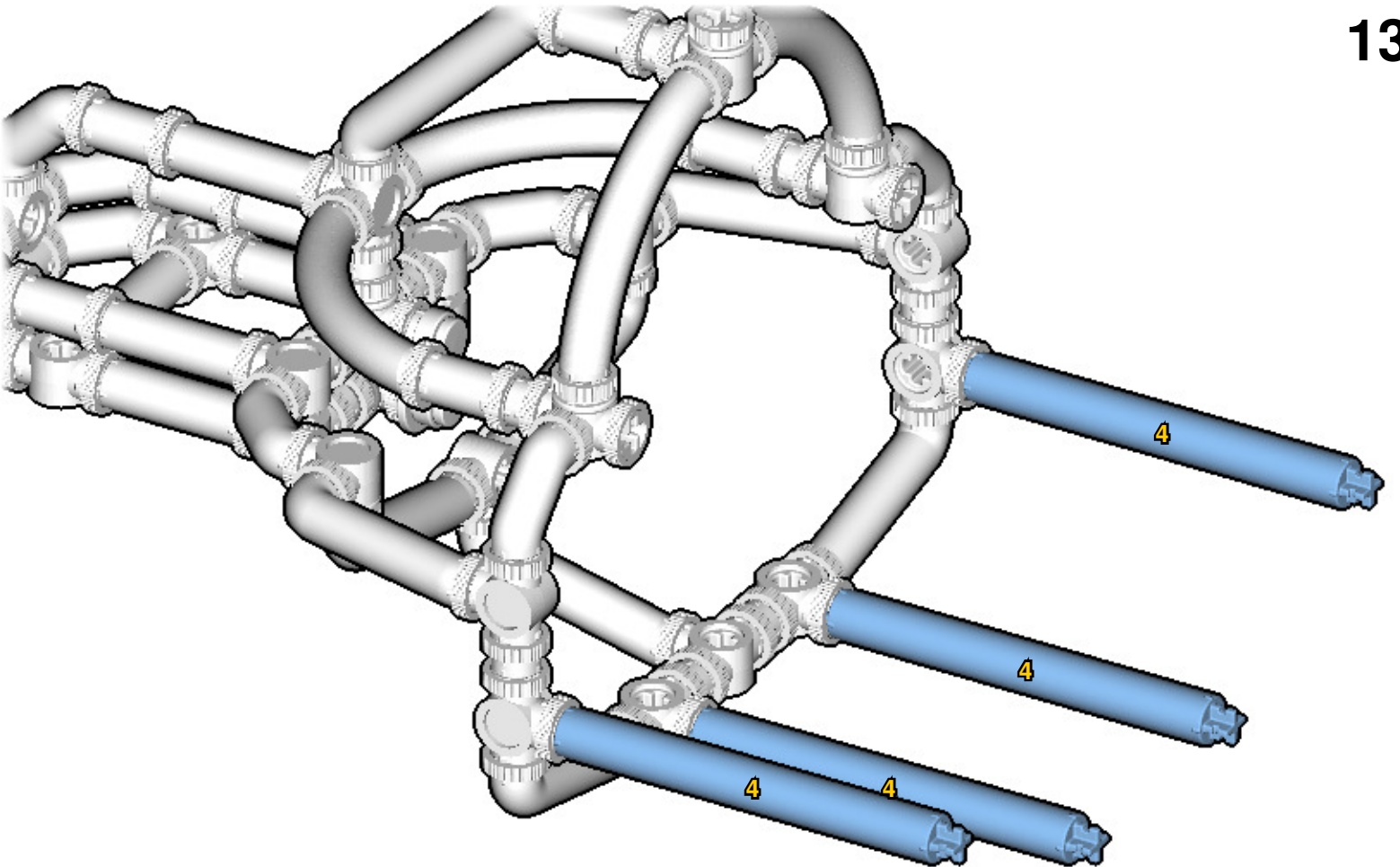

14

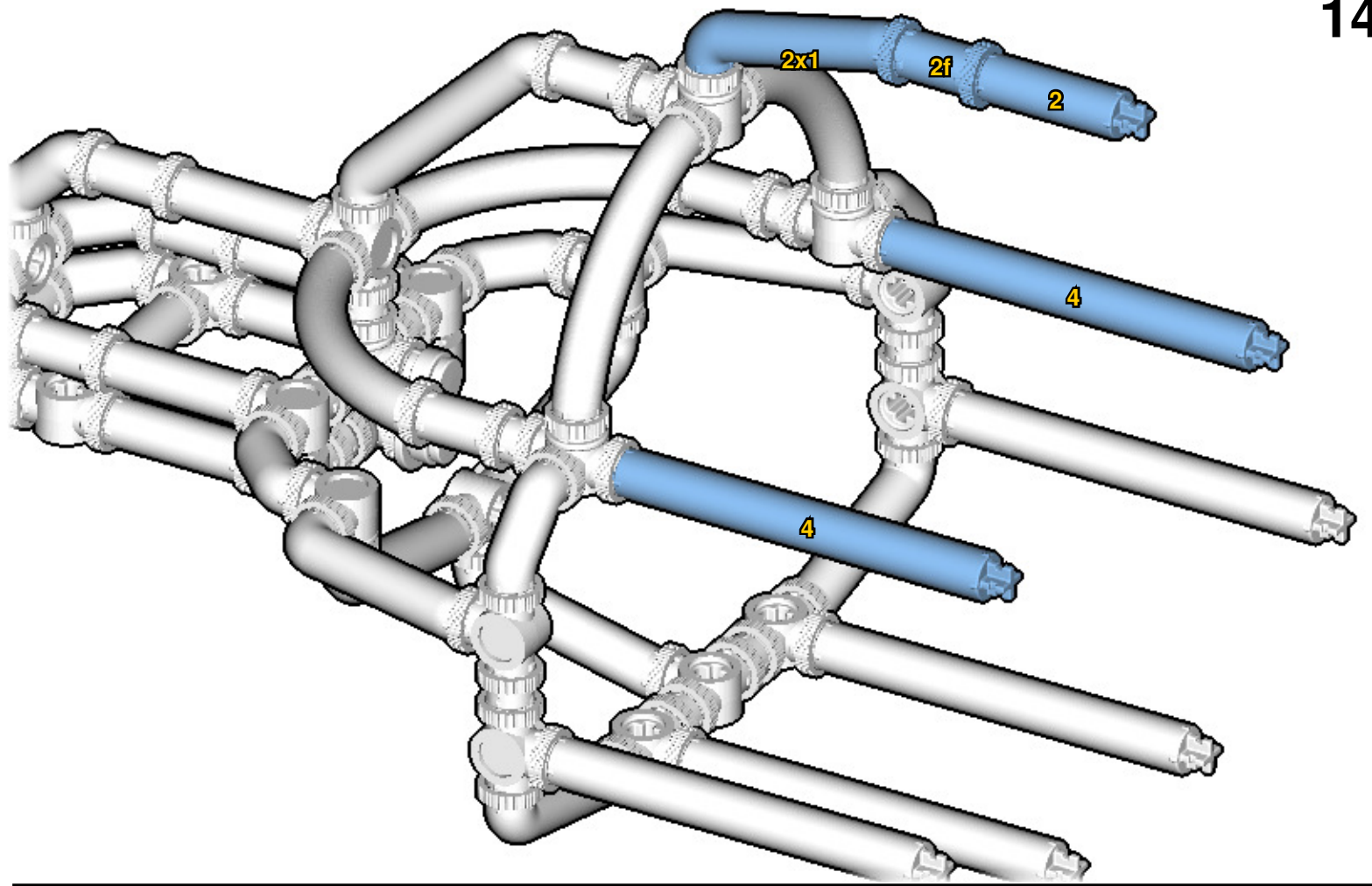

15

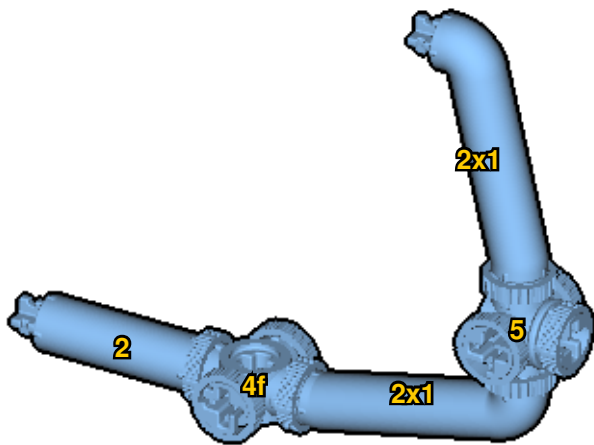

16

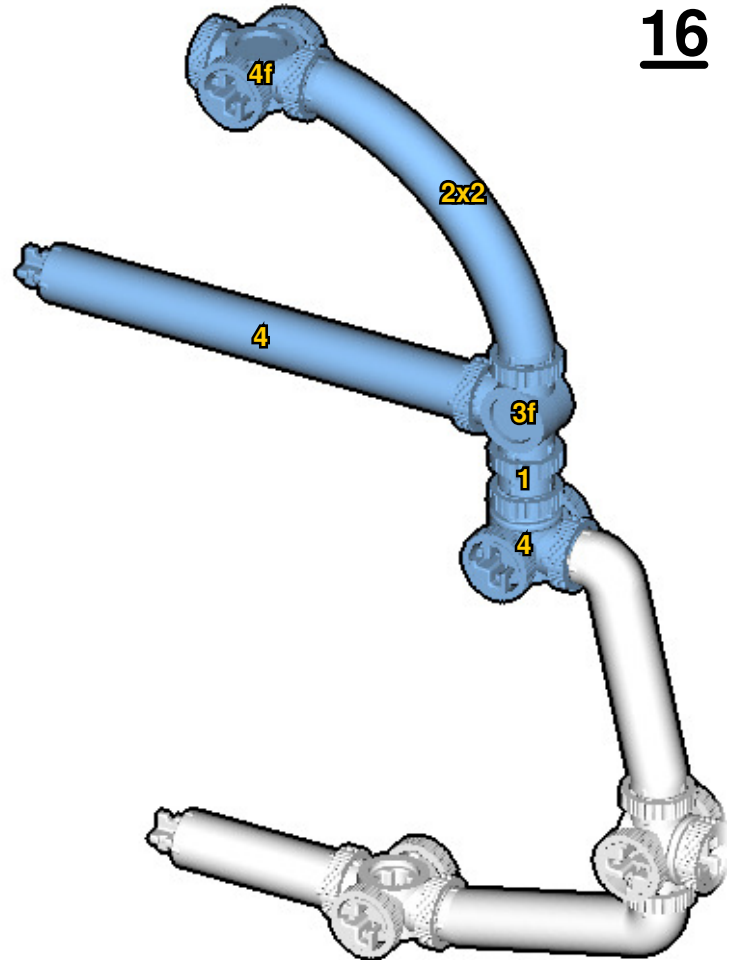

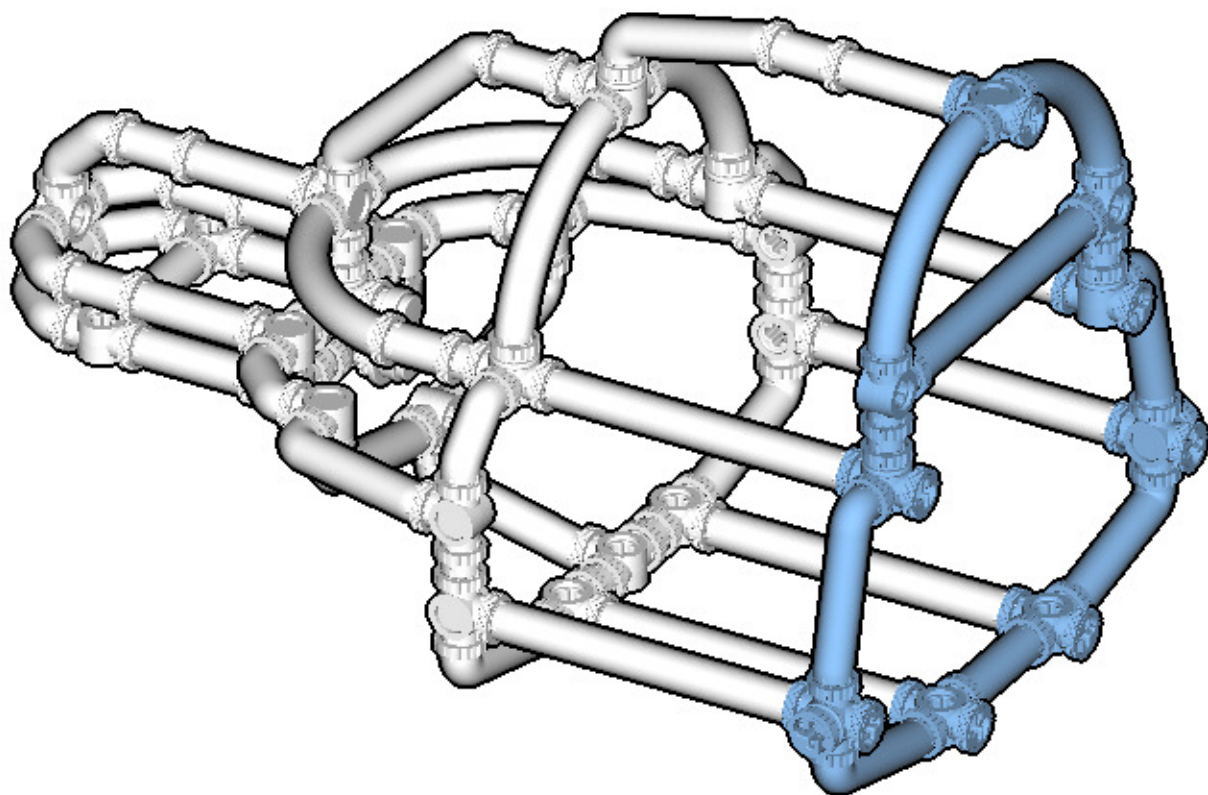
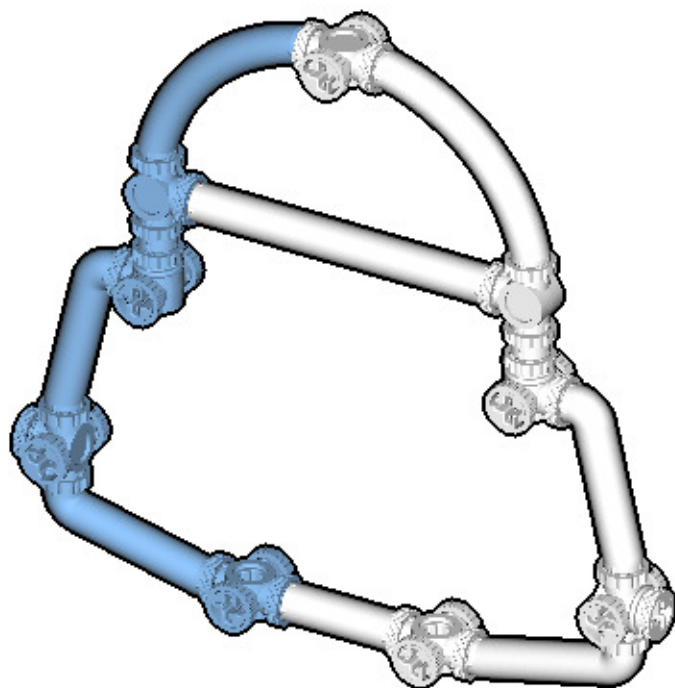

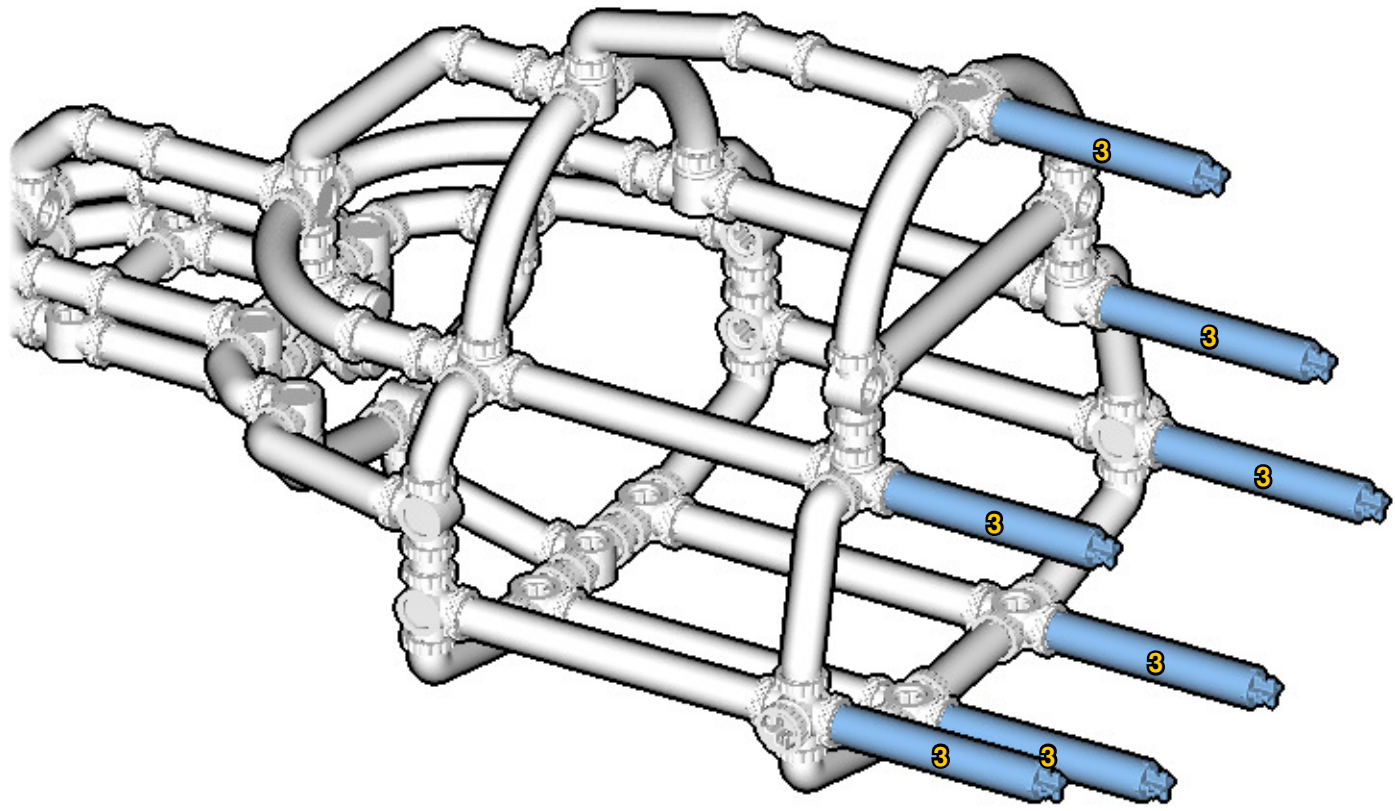

20

21

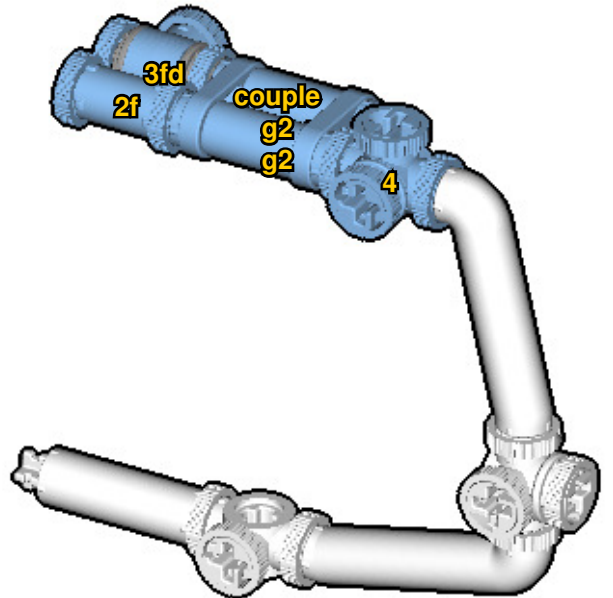
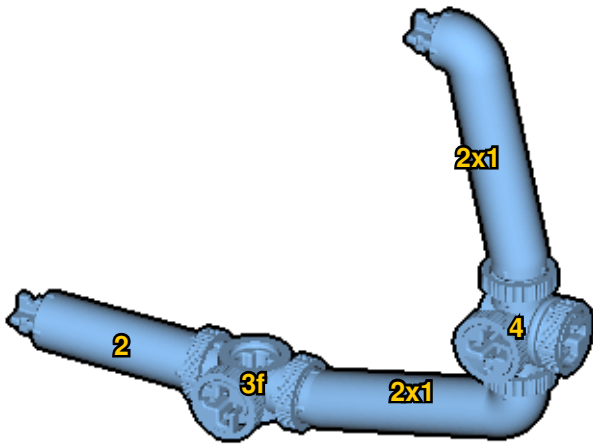
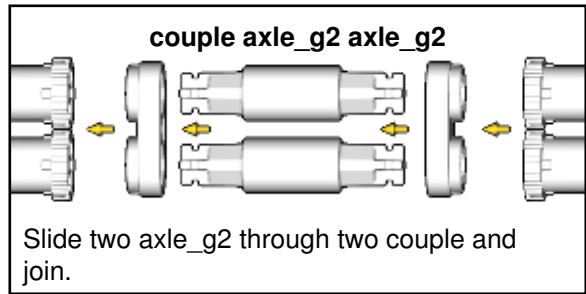

22

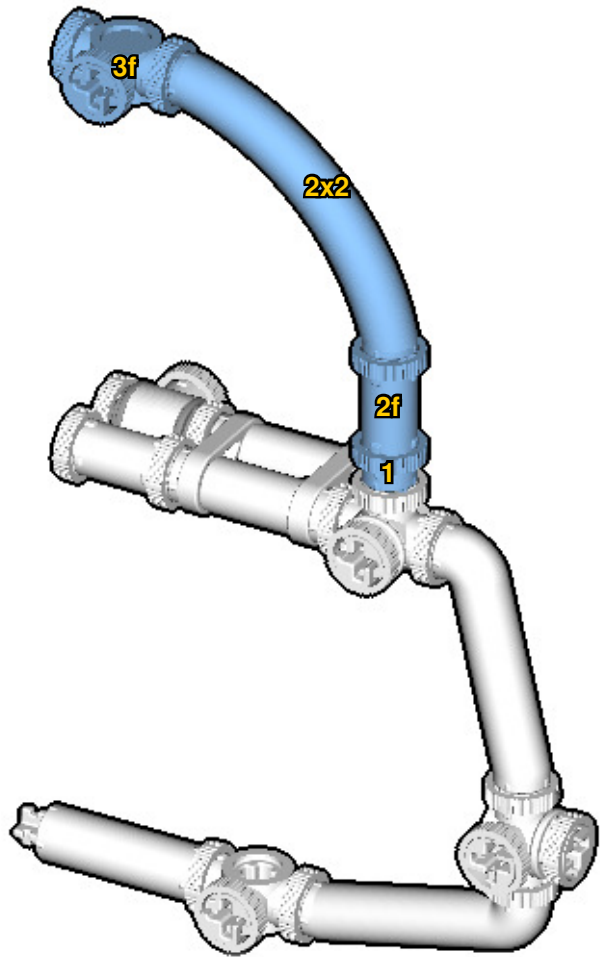

23

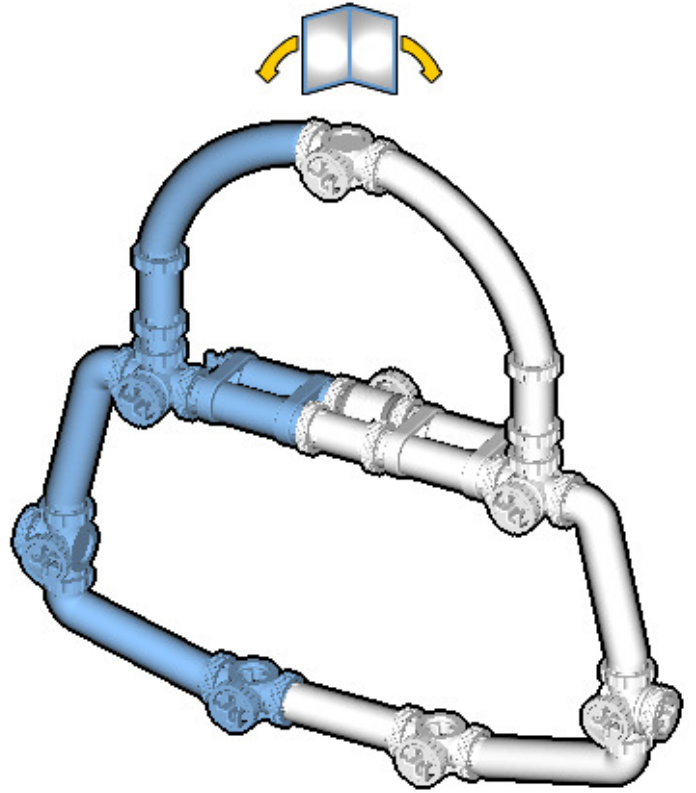

24

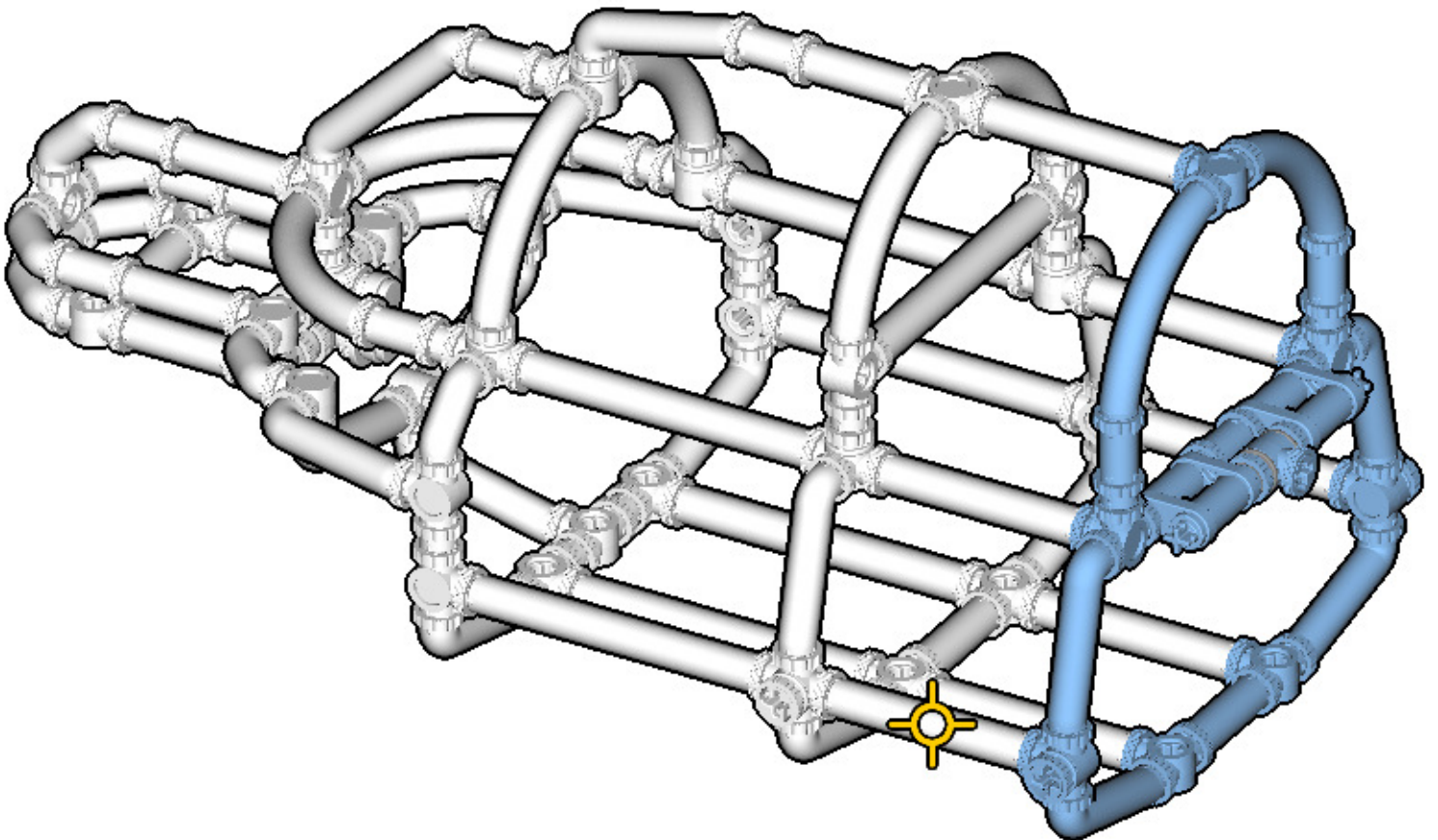

✦ : The next frame is centered on this piece.

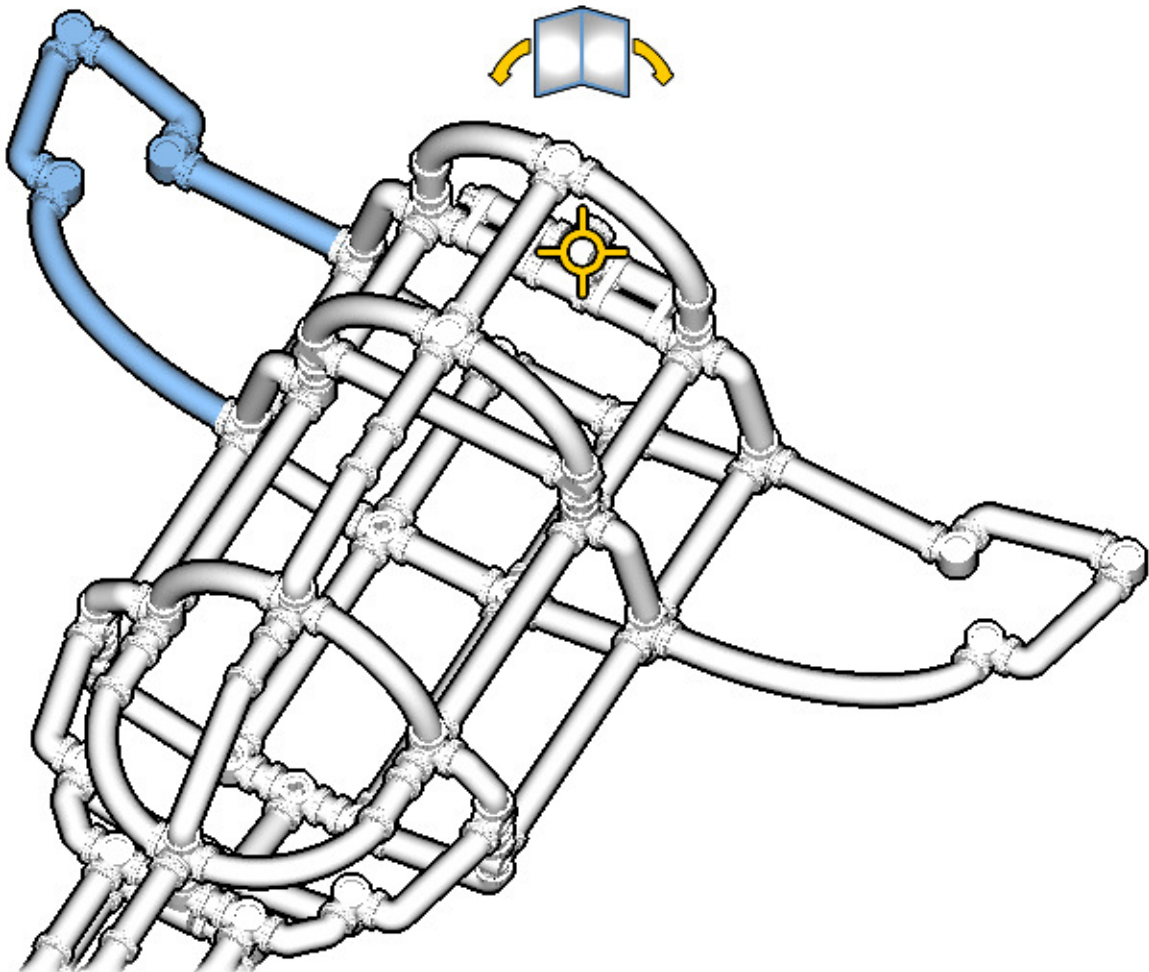
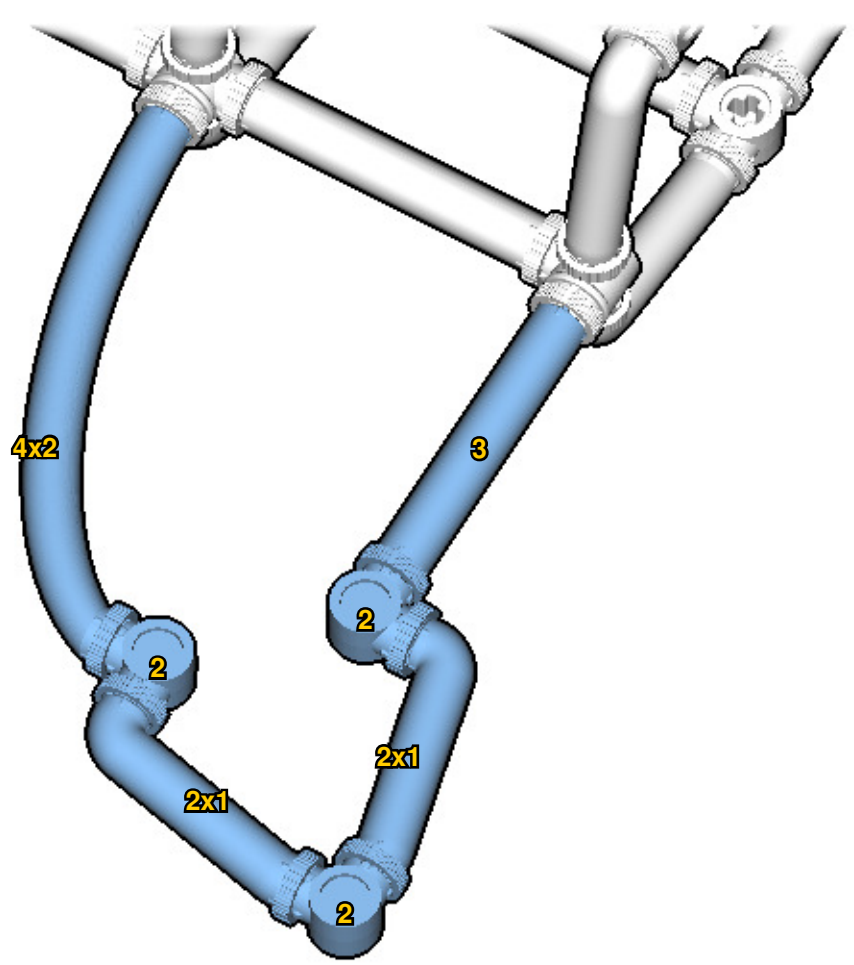

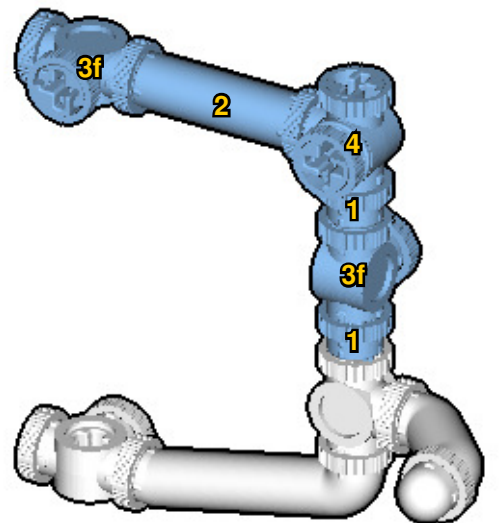
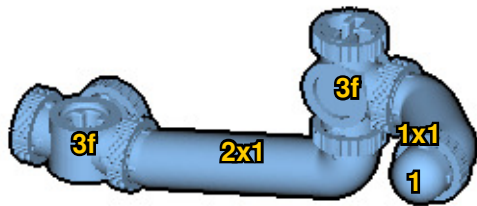
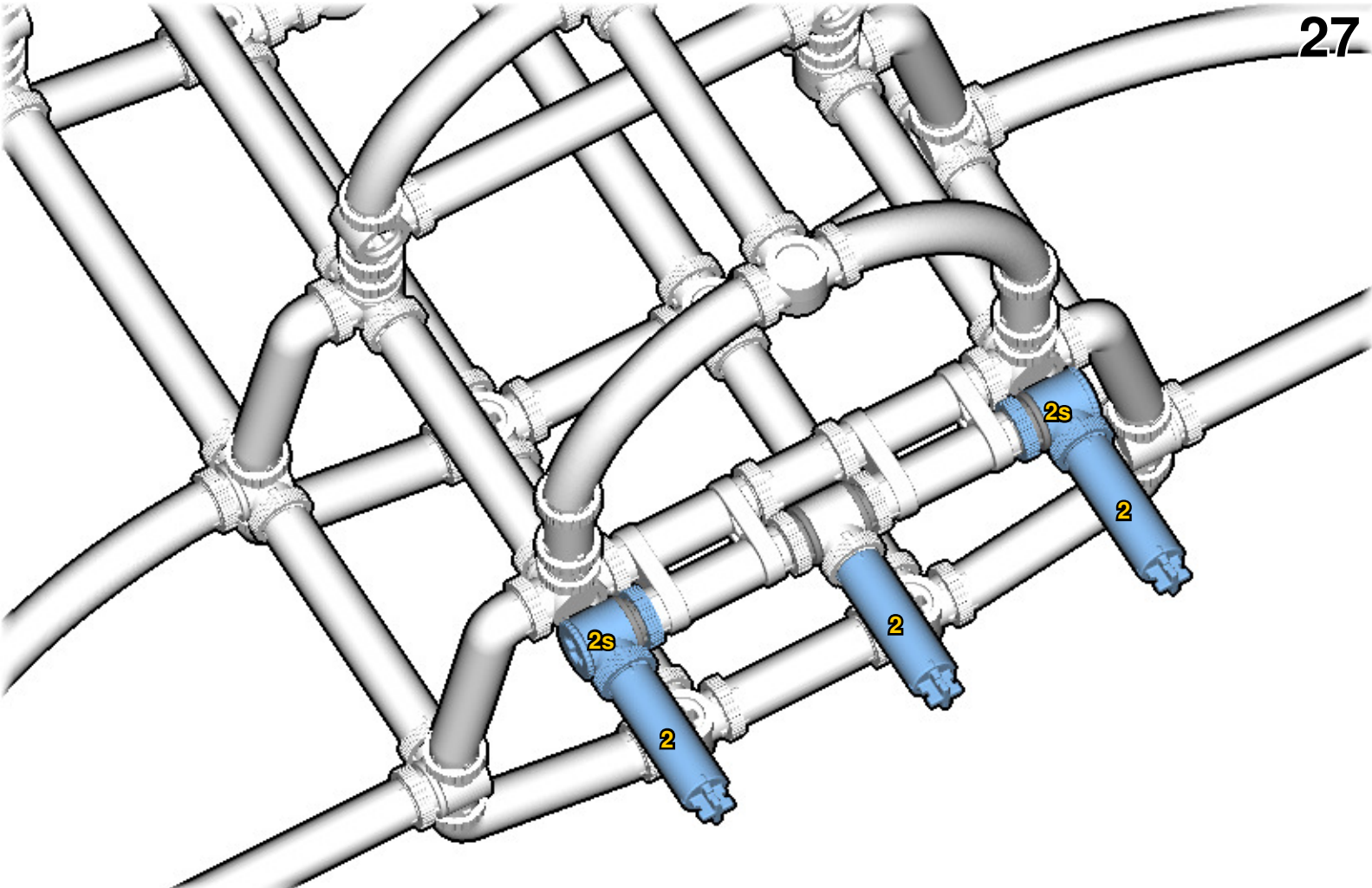

30

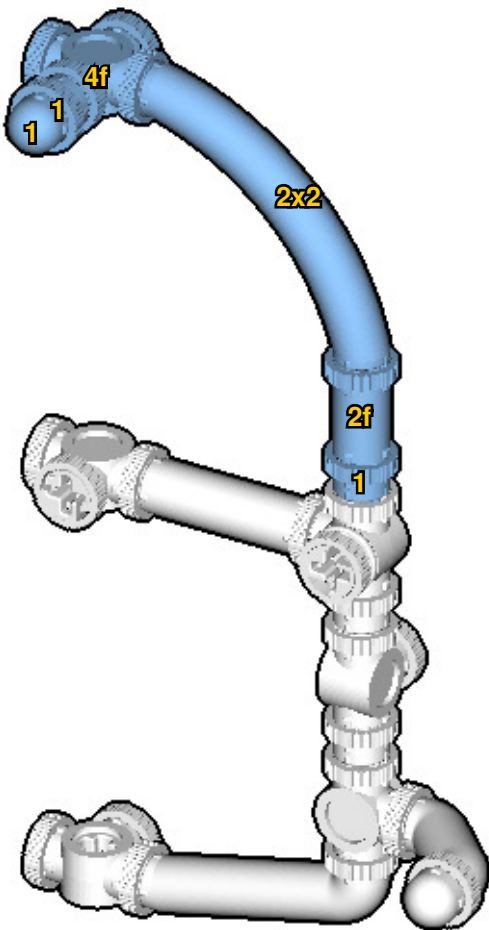

31

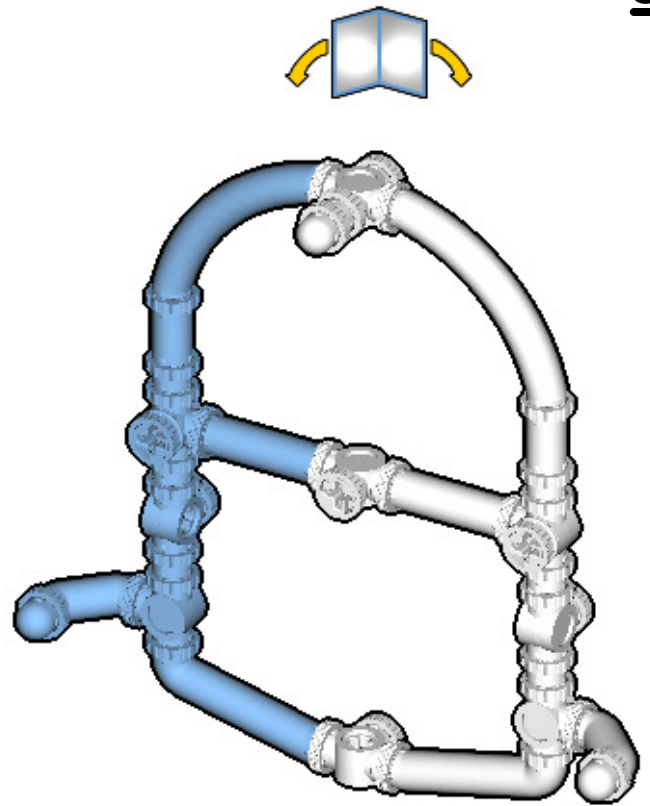

32

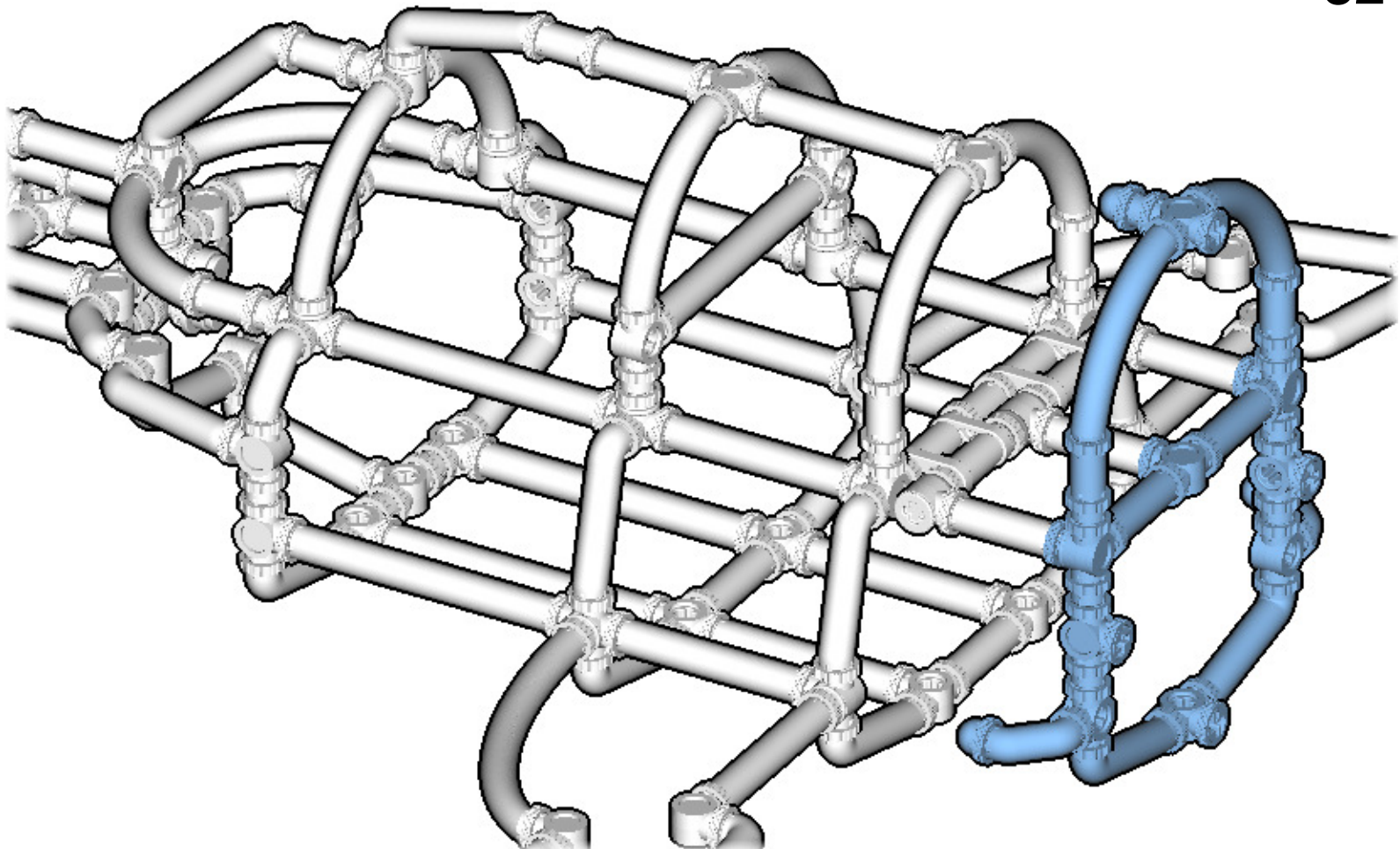

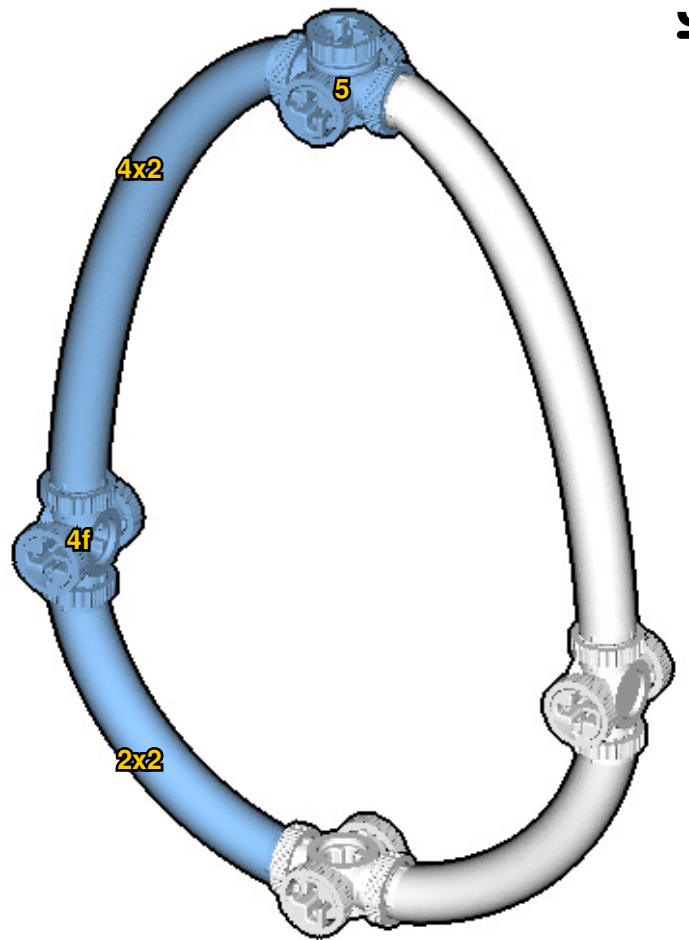
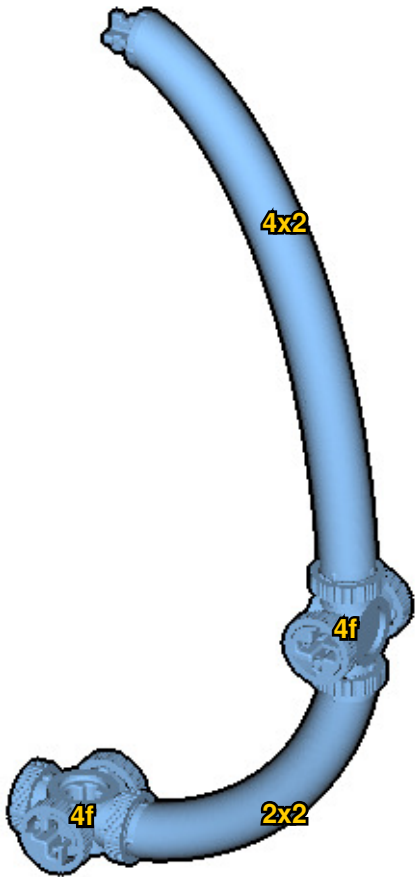
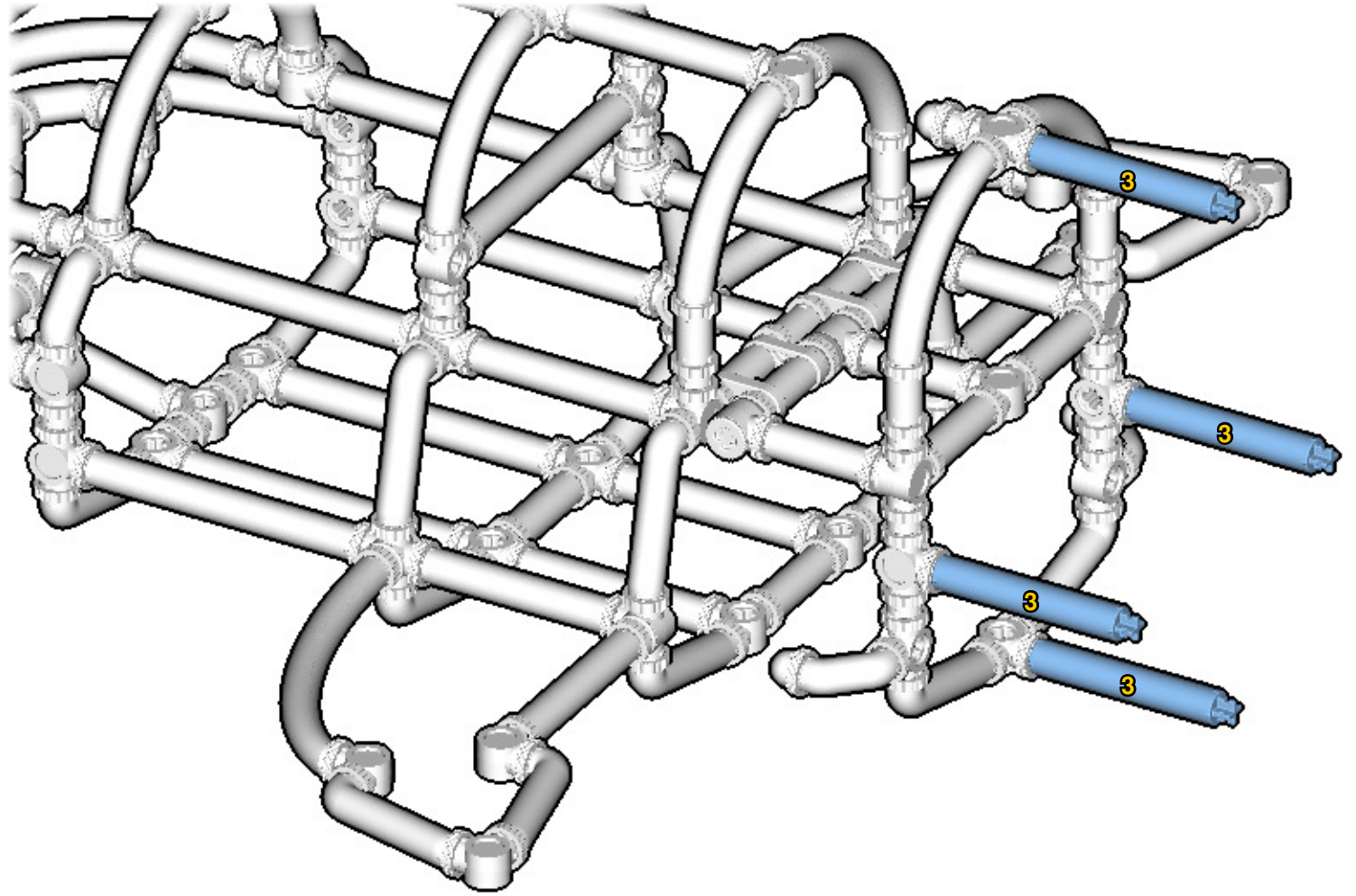

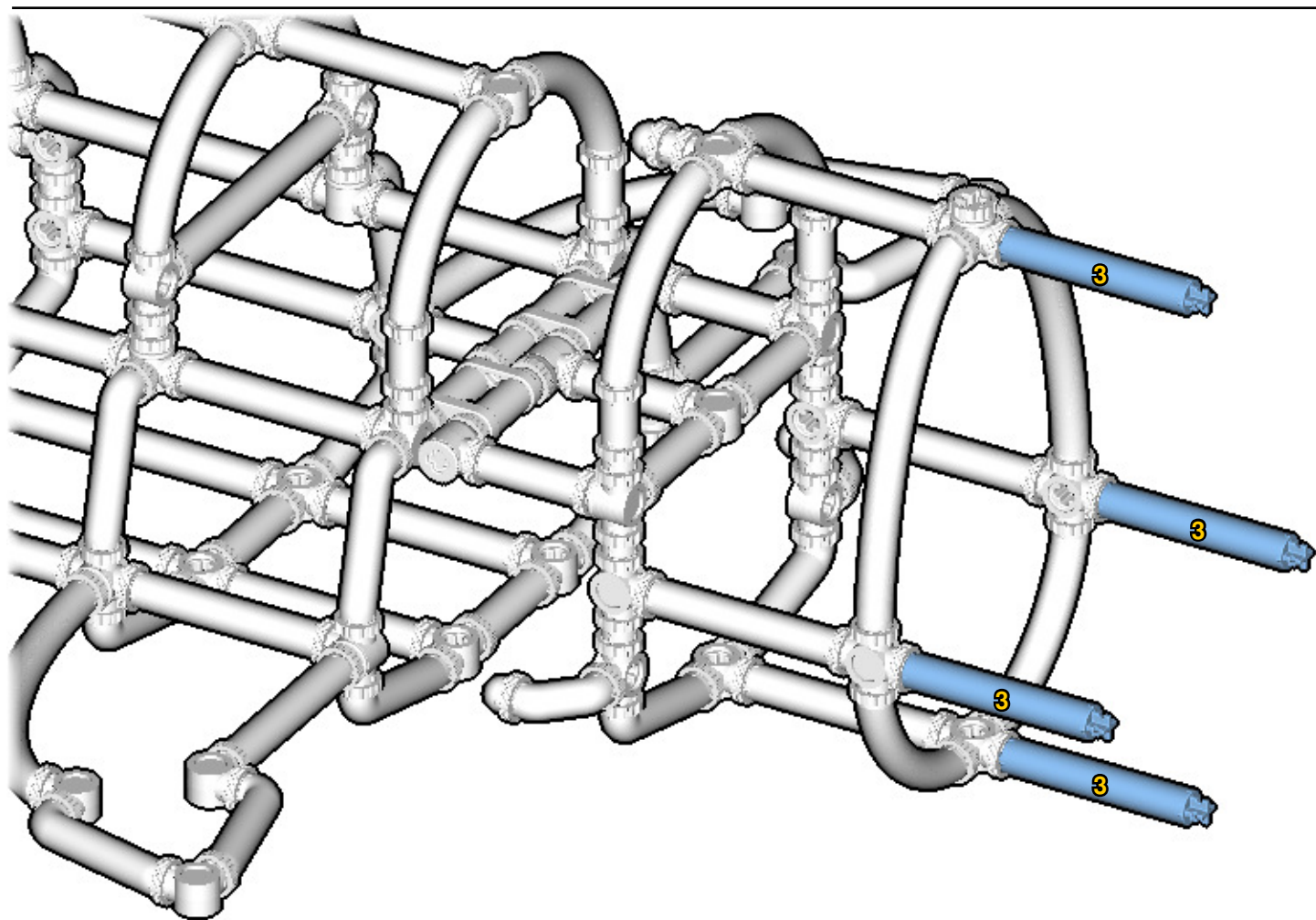
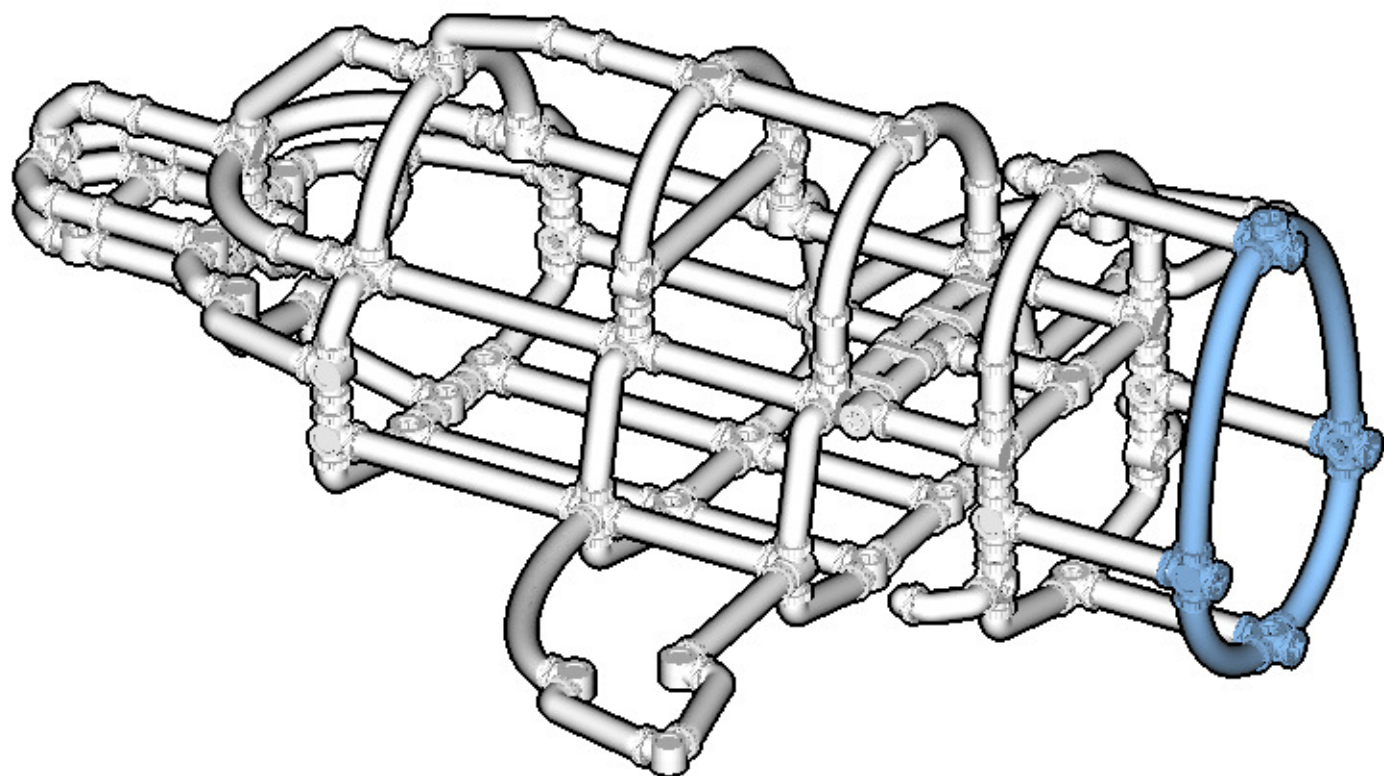

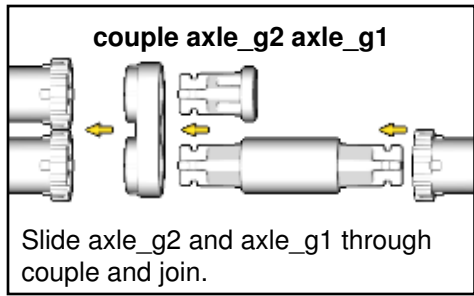

38

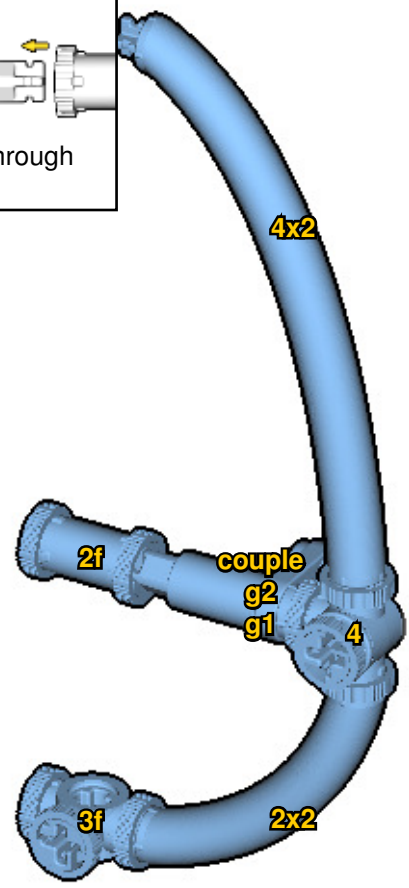

39

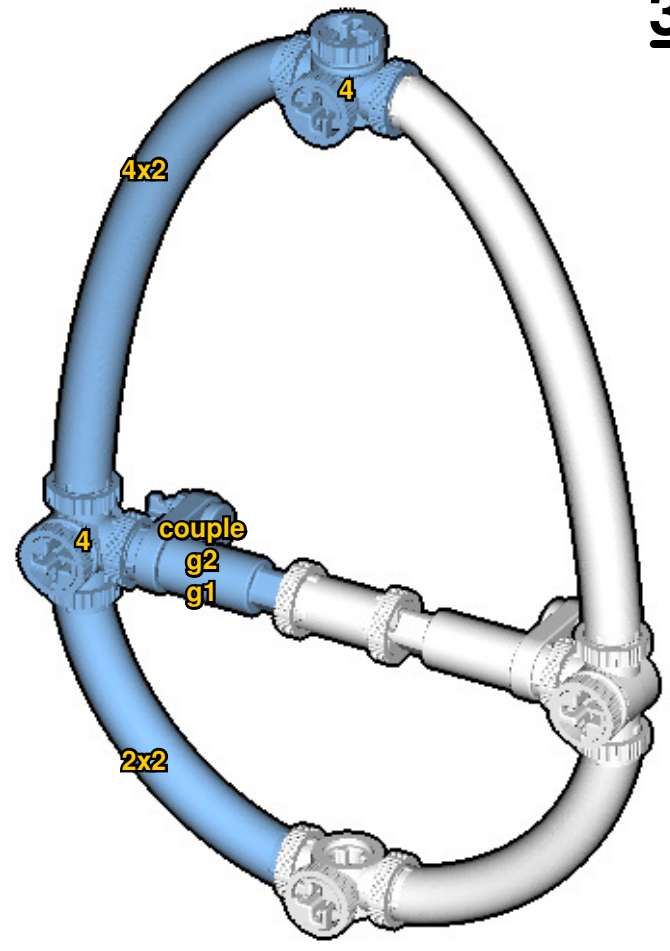

40

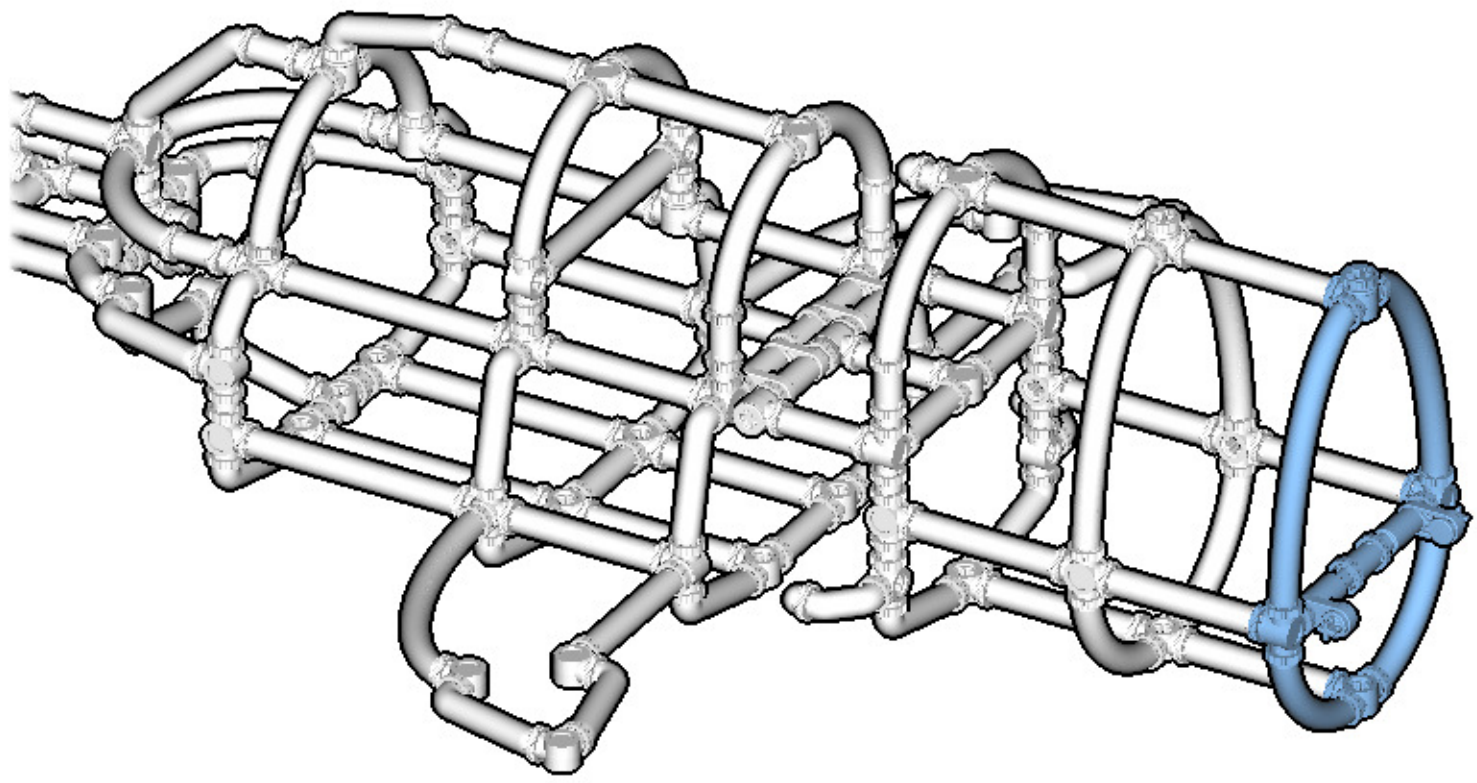

41

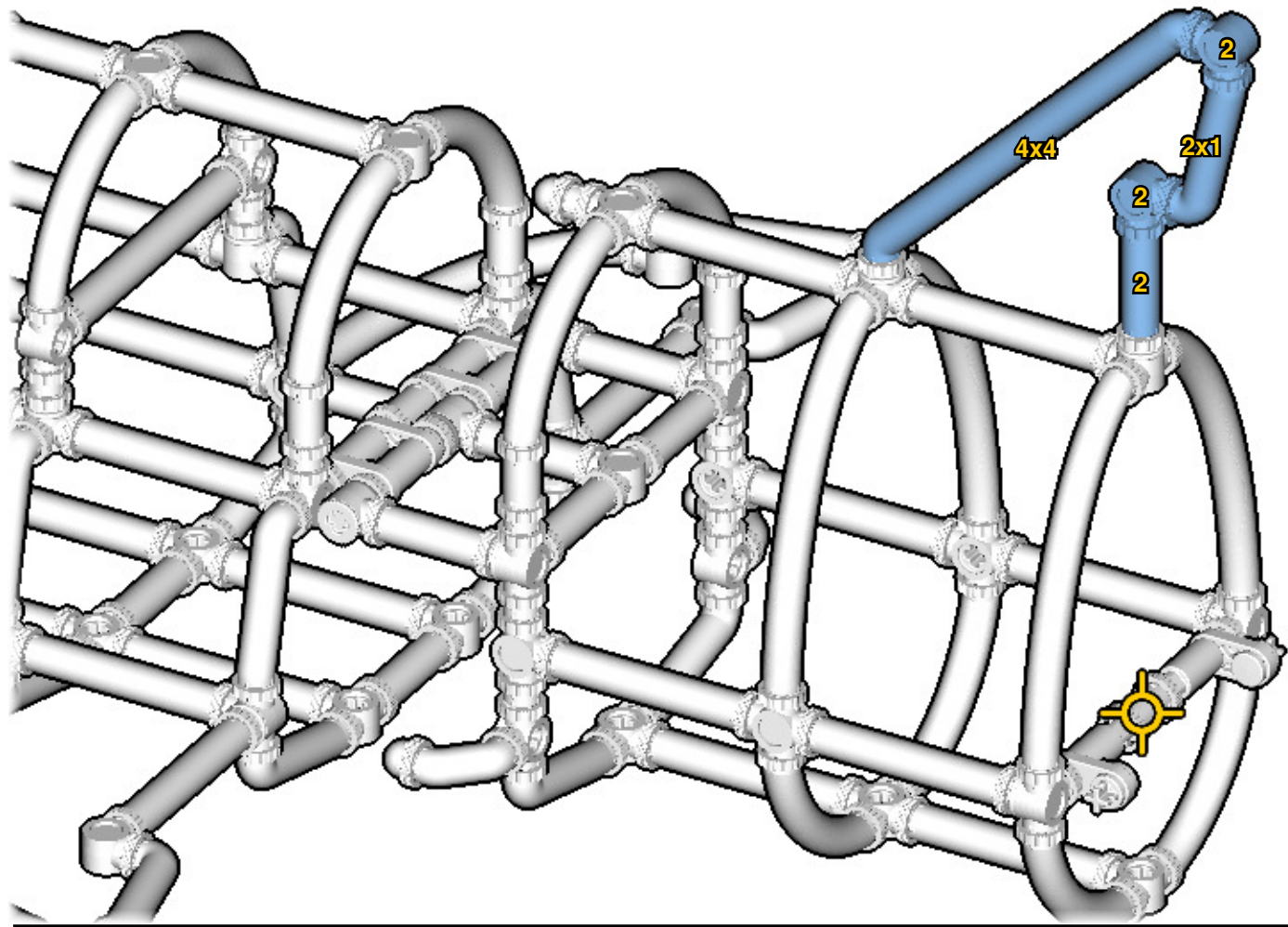

42

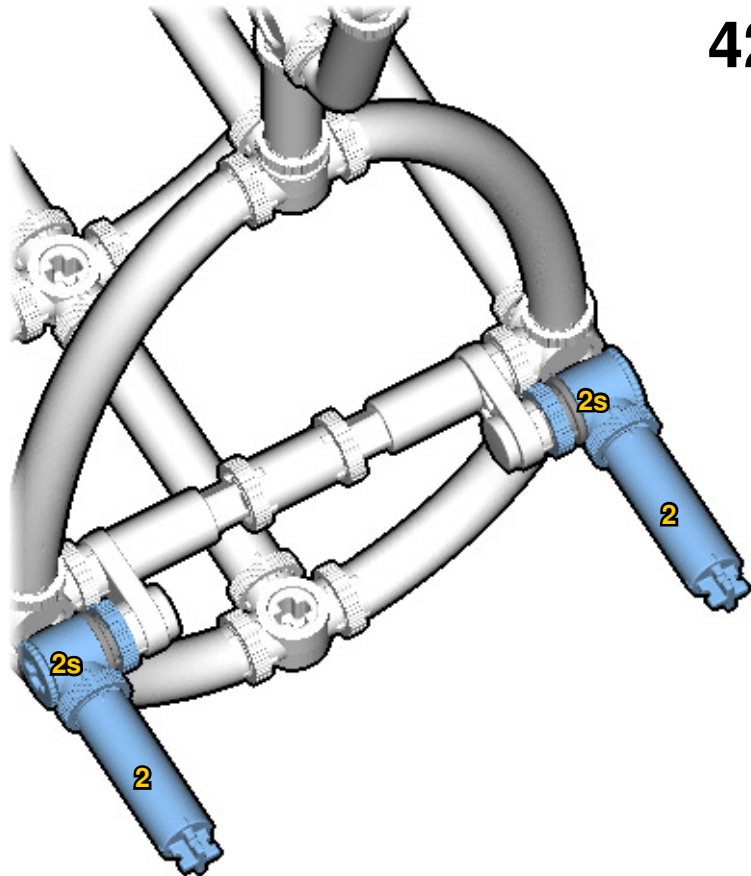

43

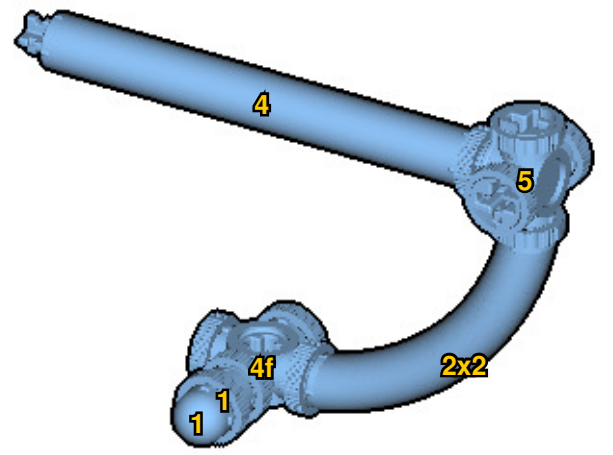

44

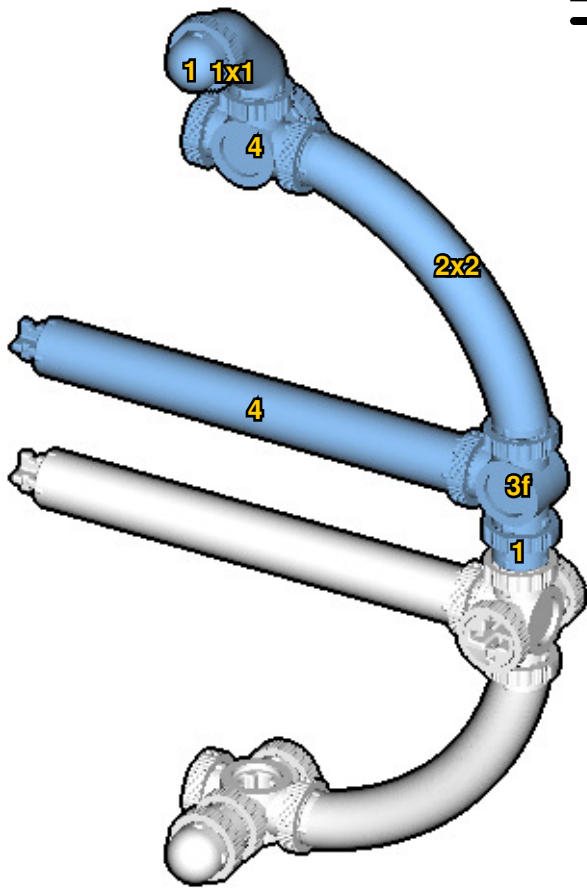

45

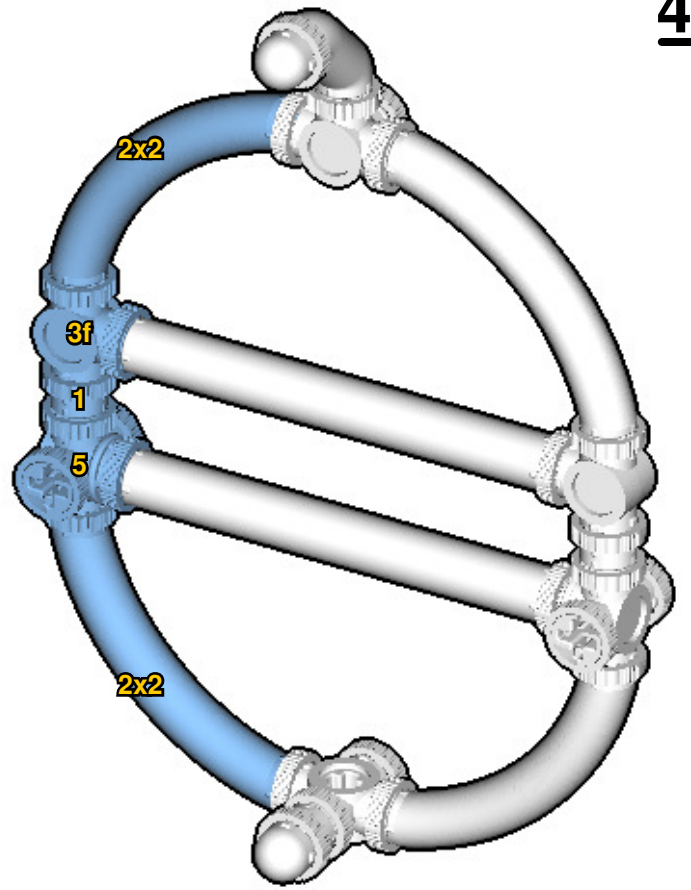

46

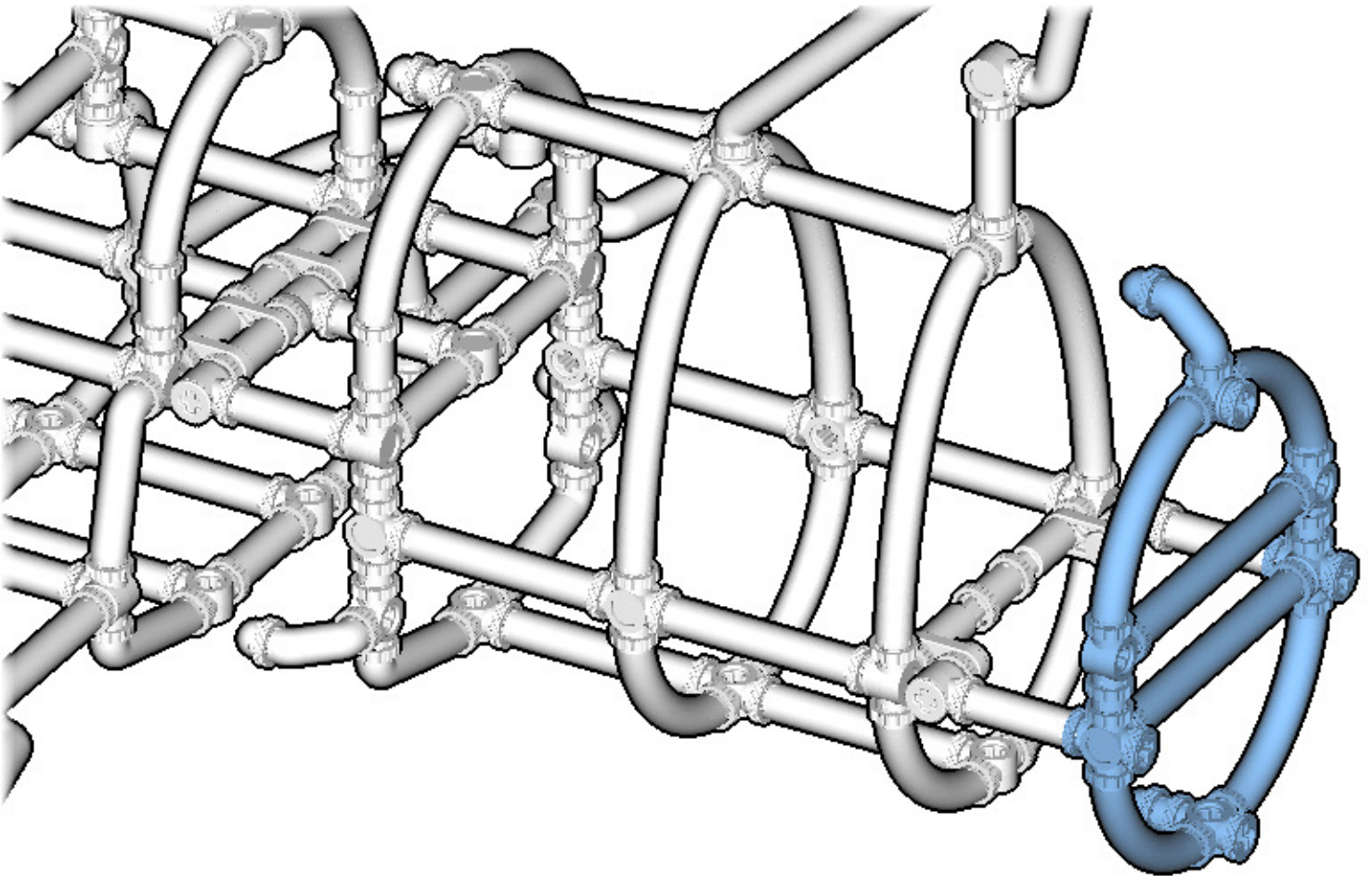

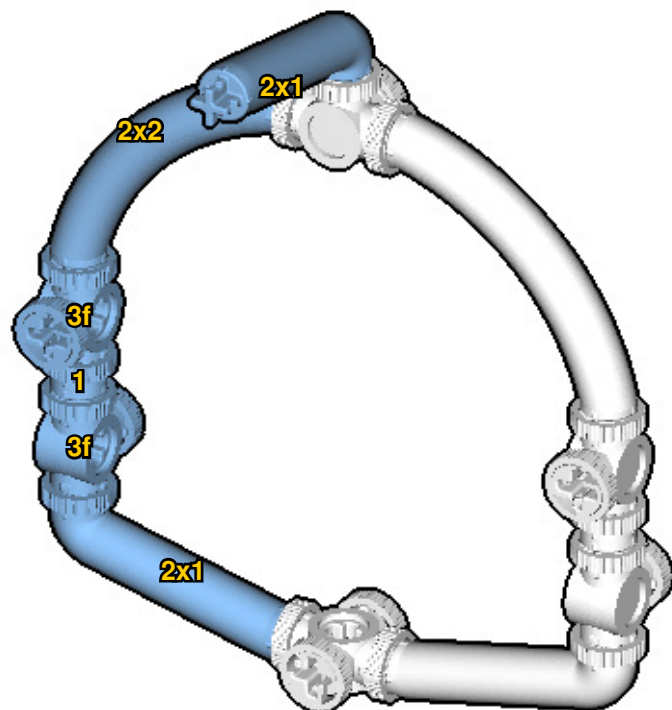
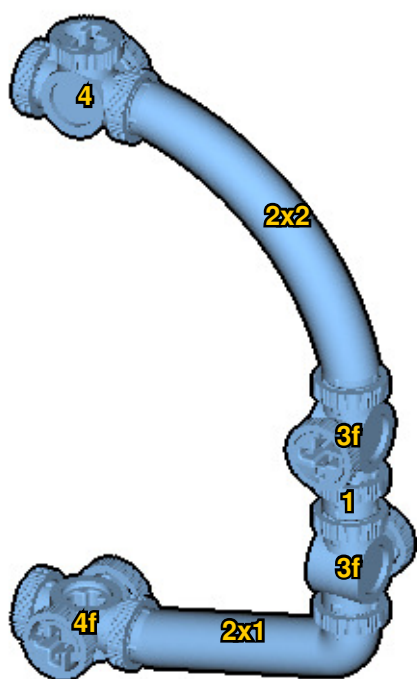
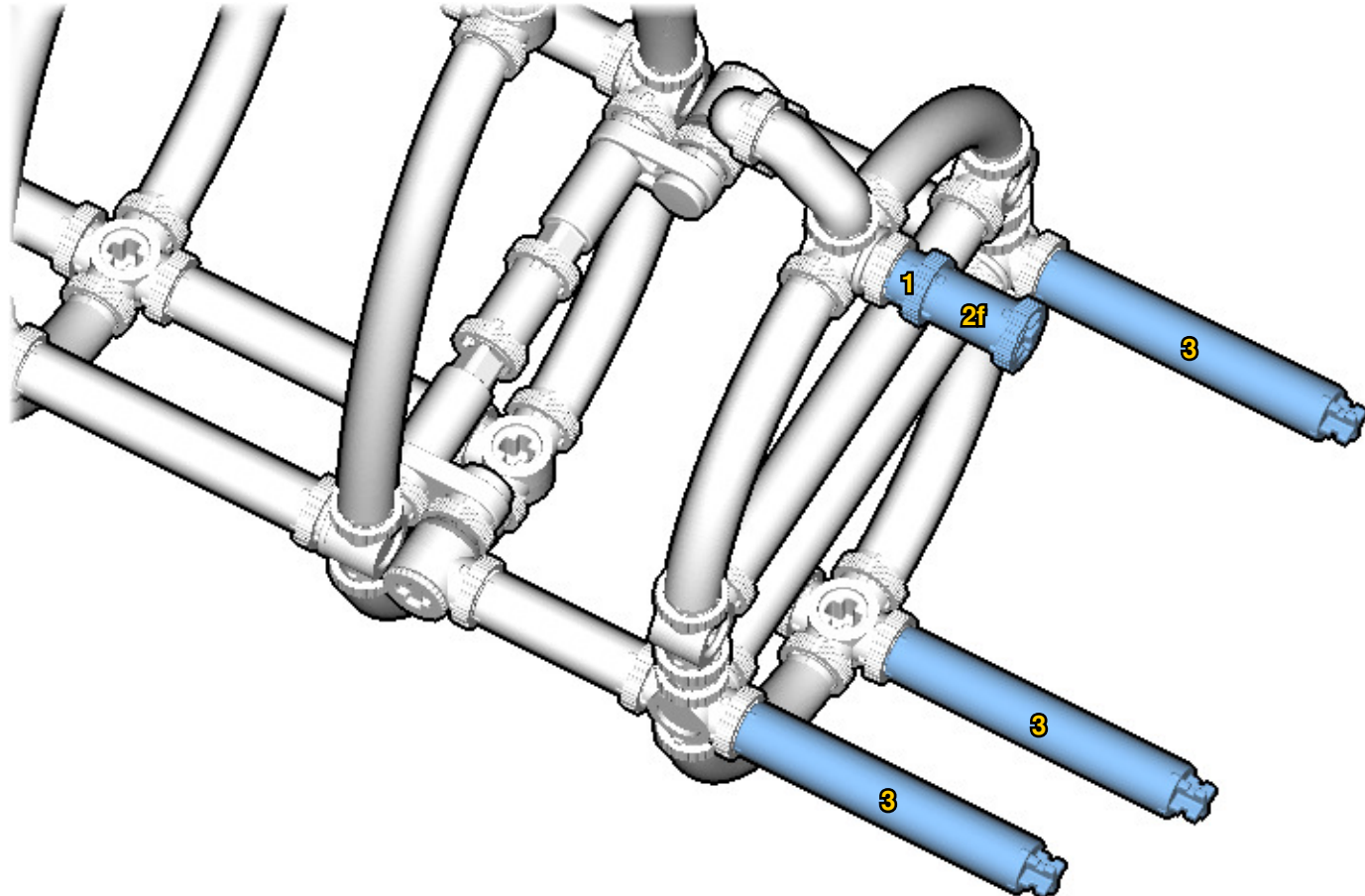

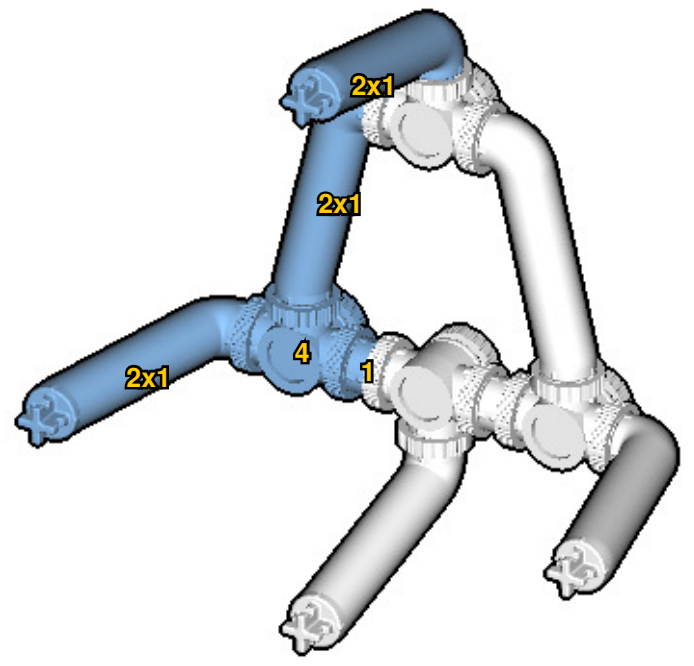
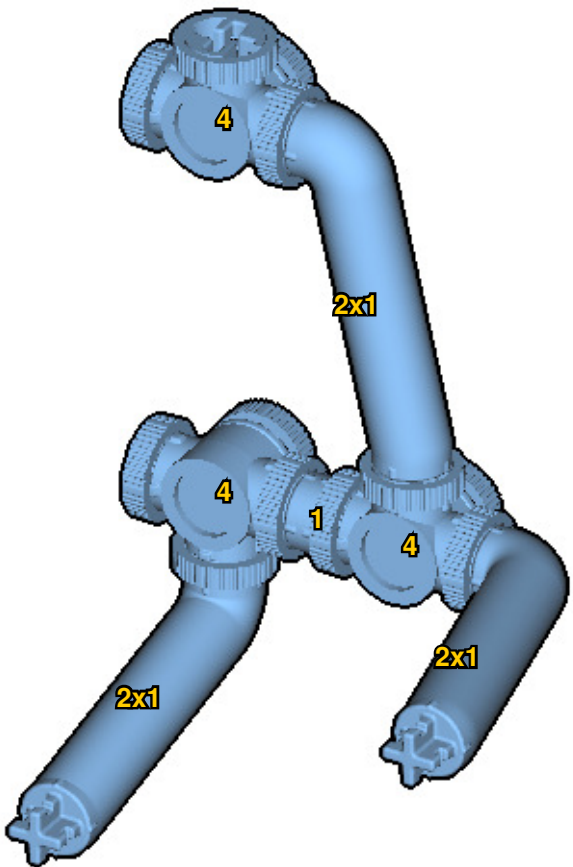
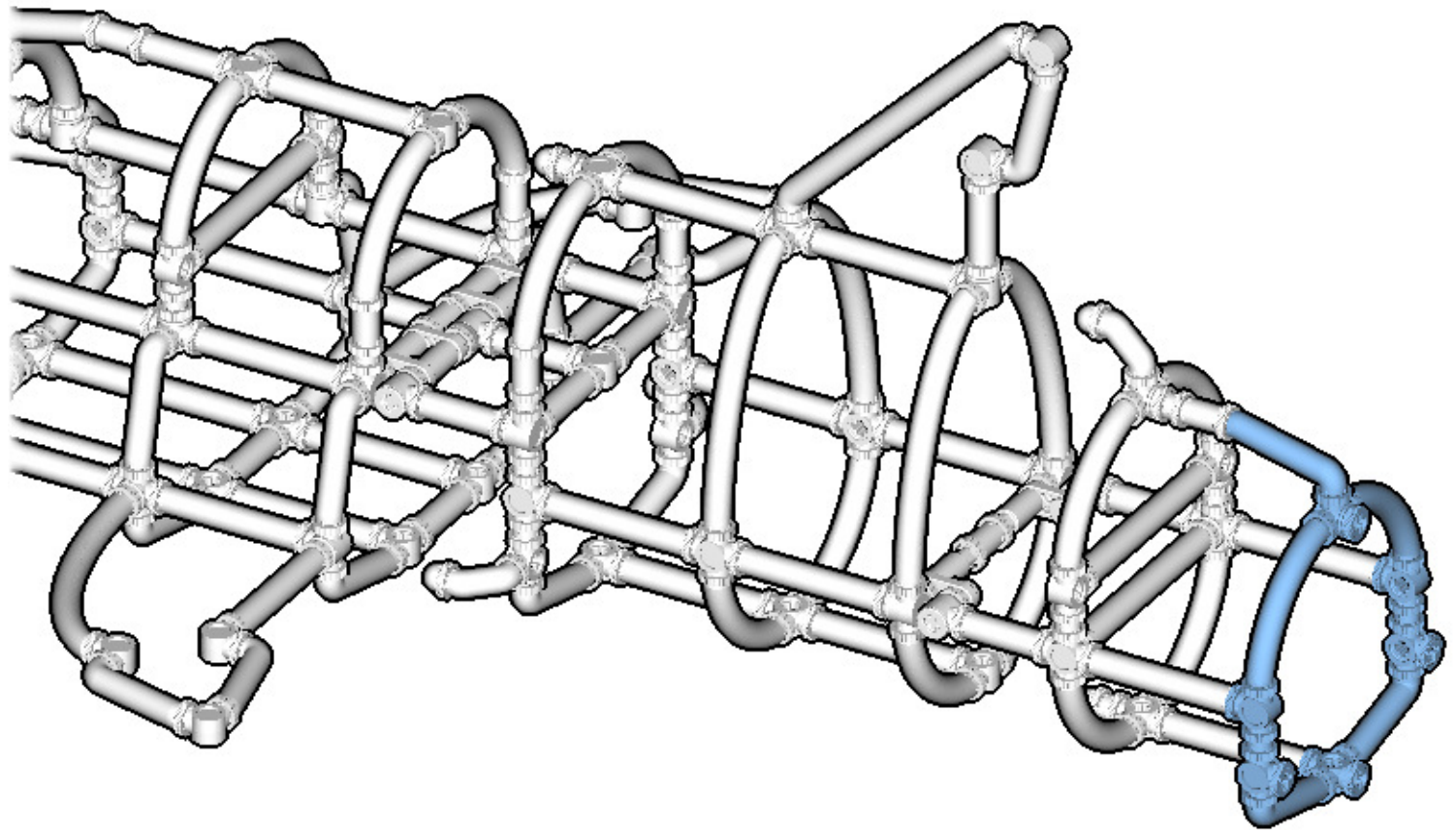

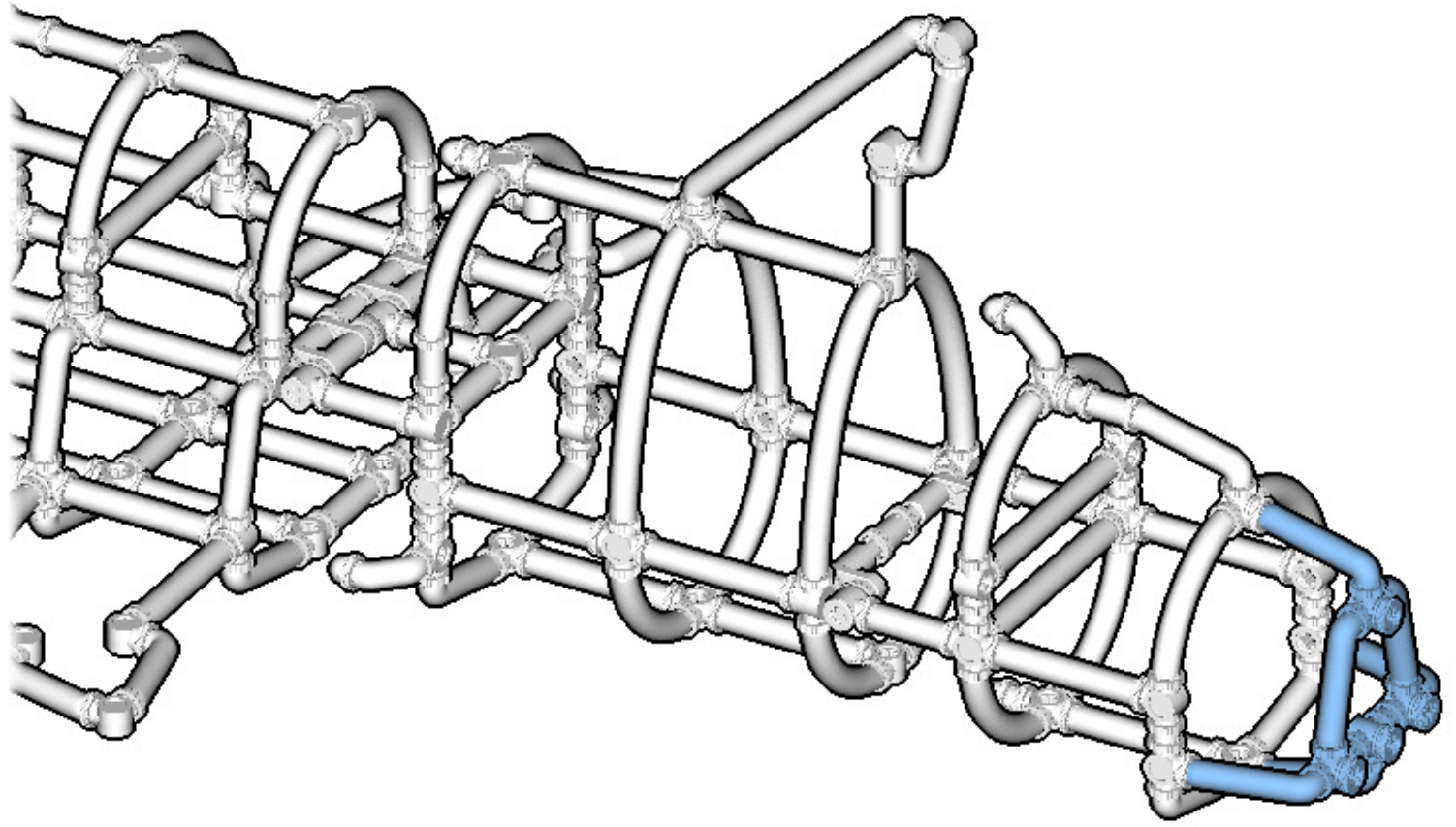
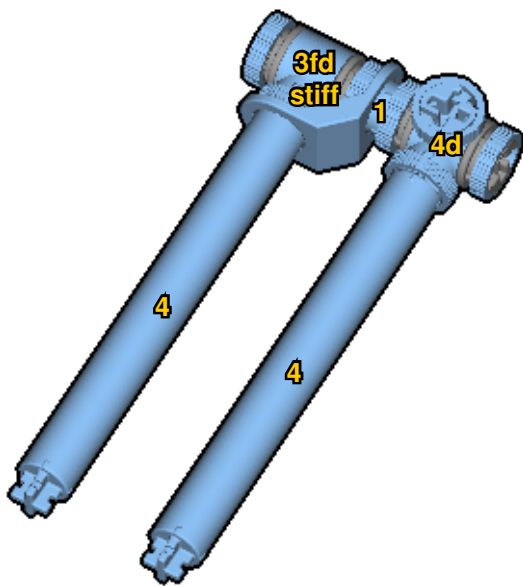
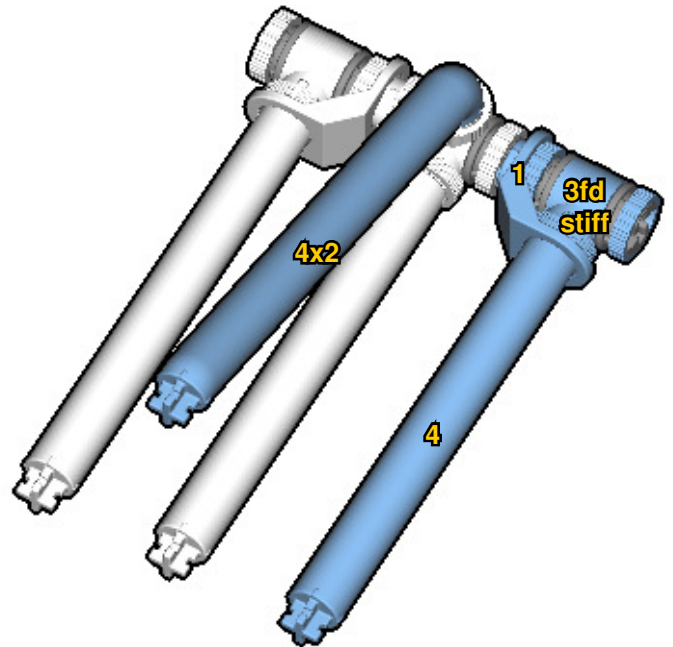
5455

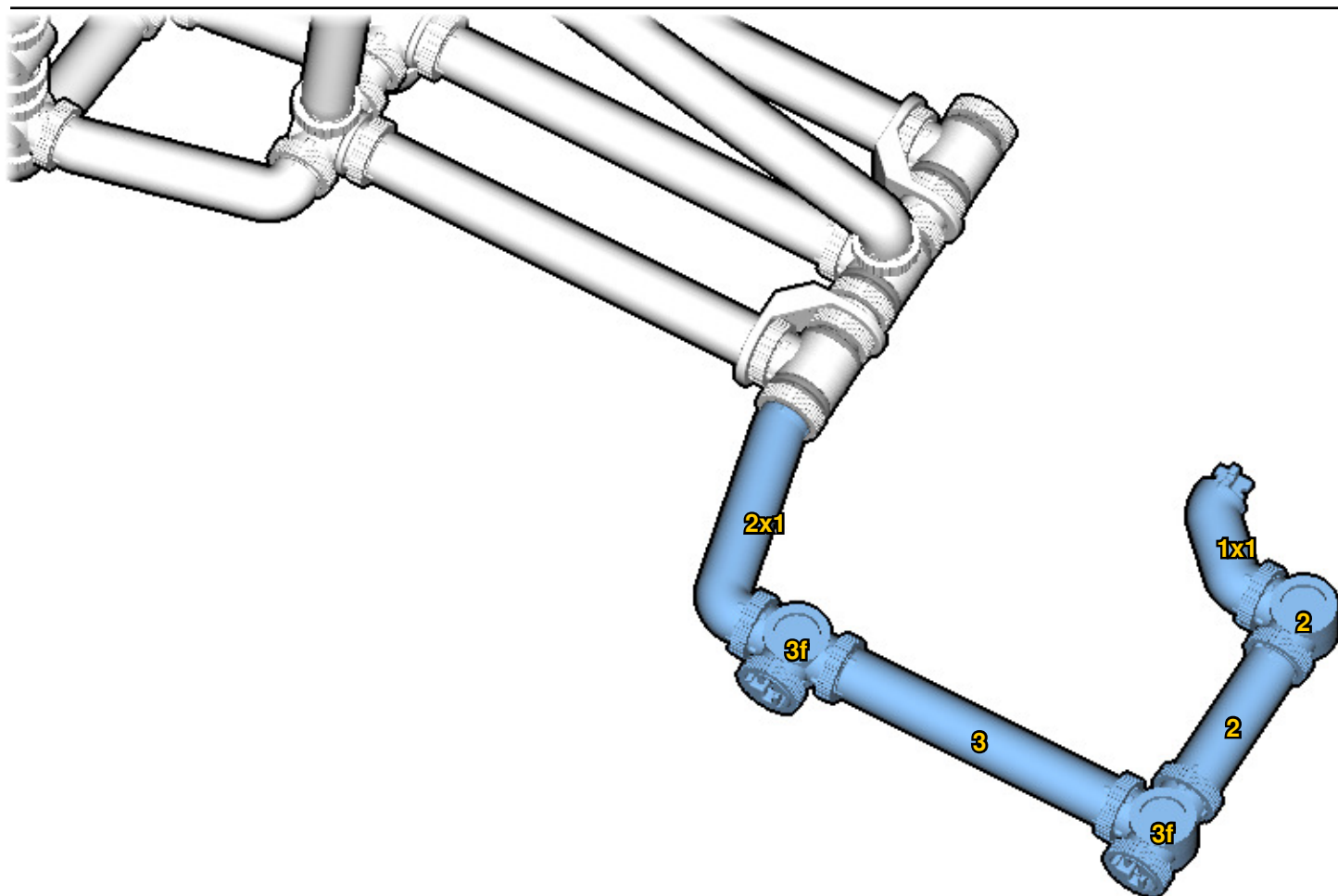
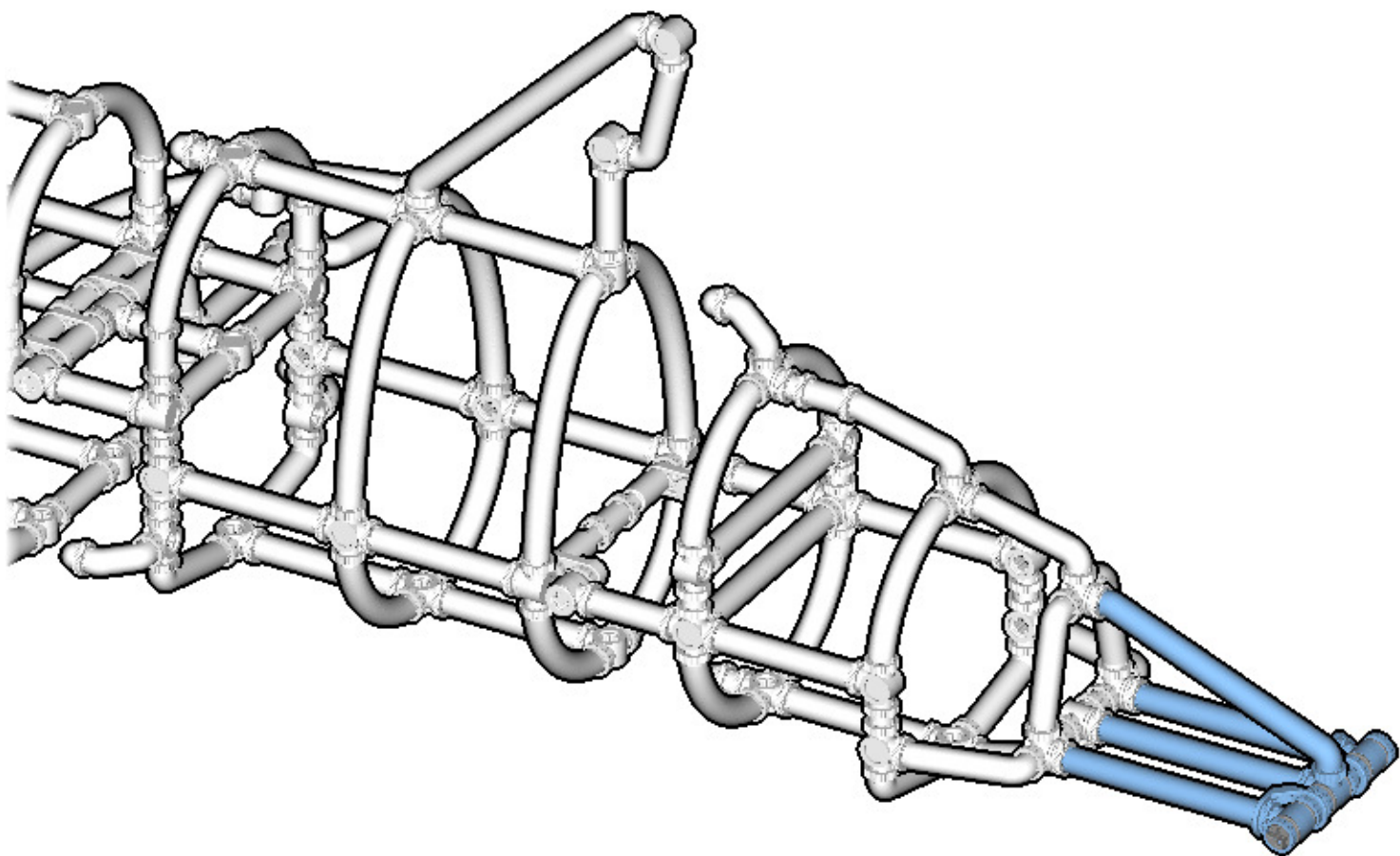

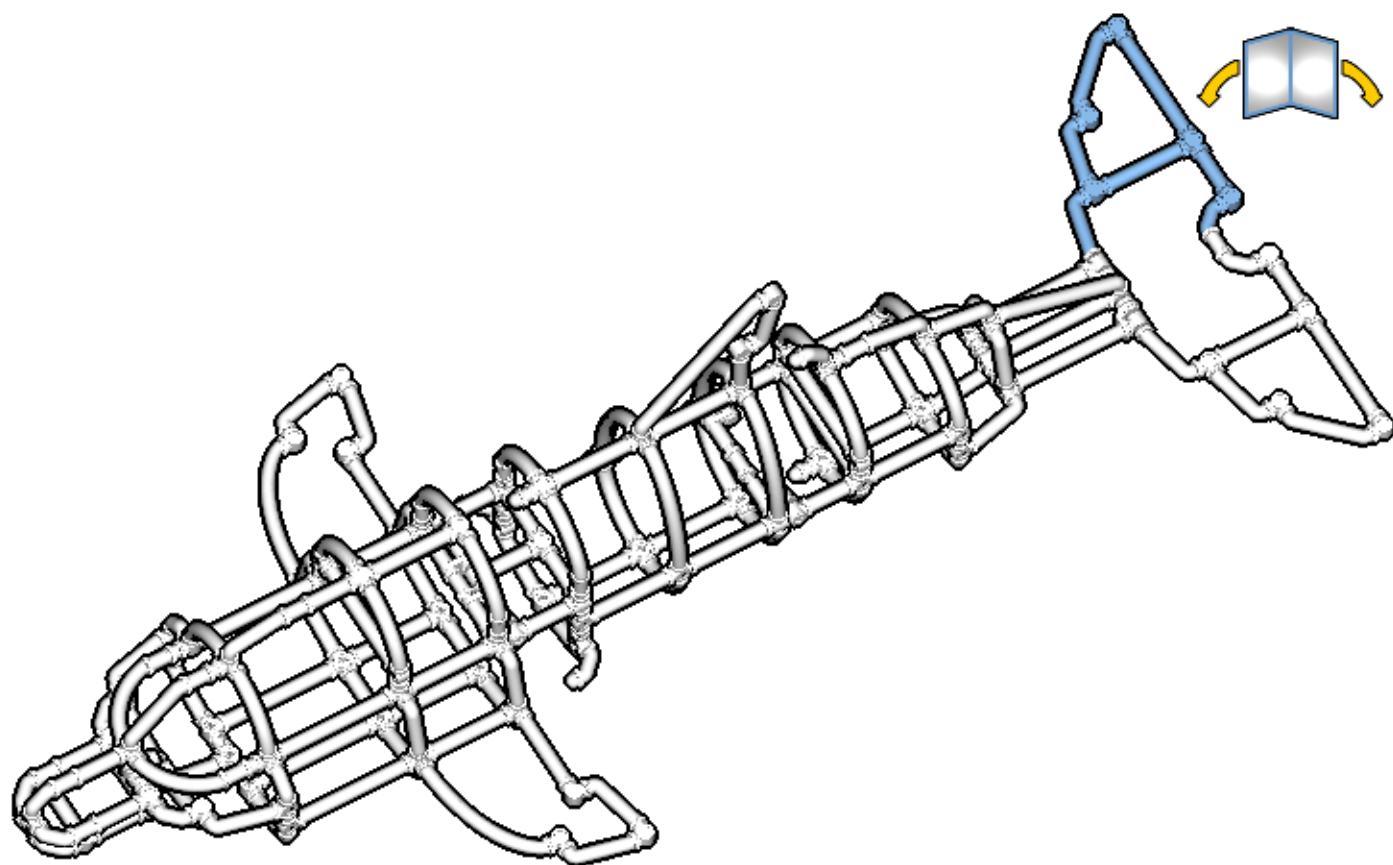
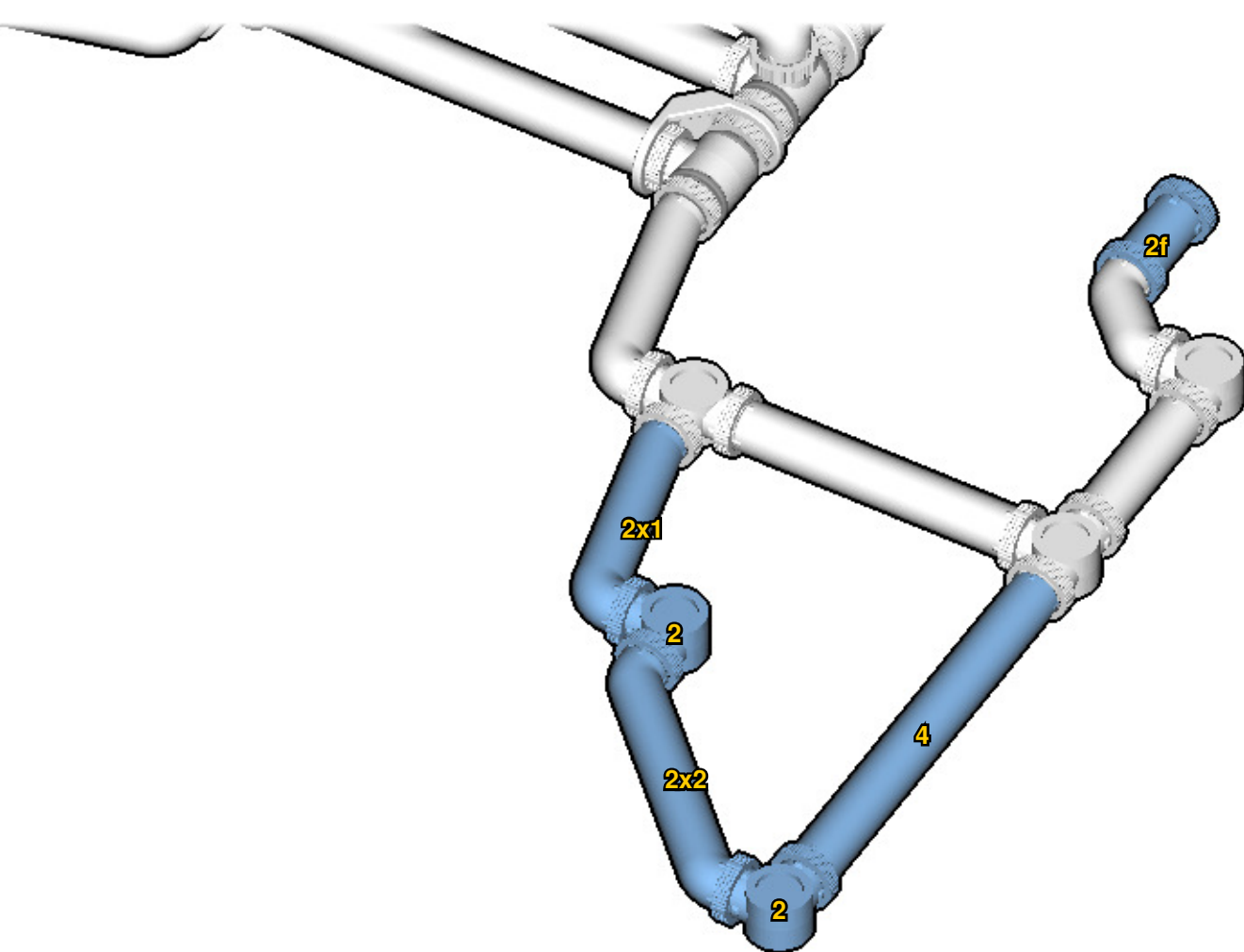

INVENTORY

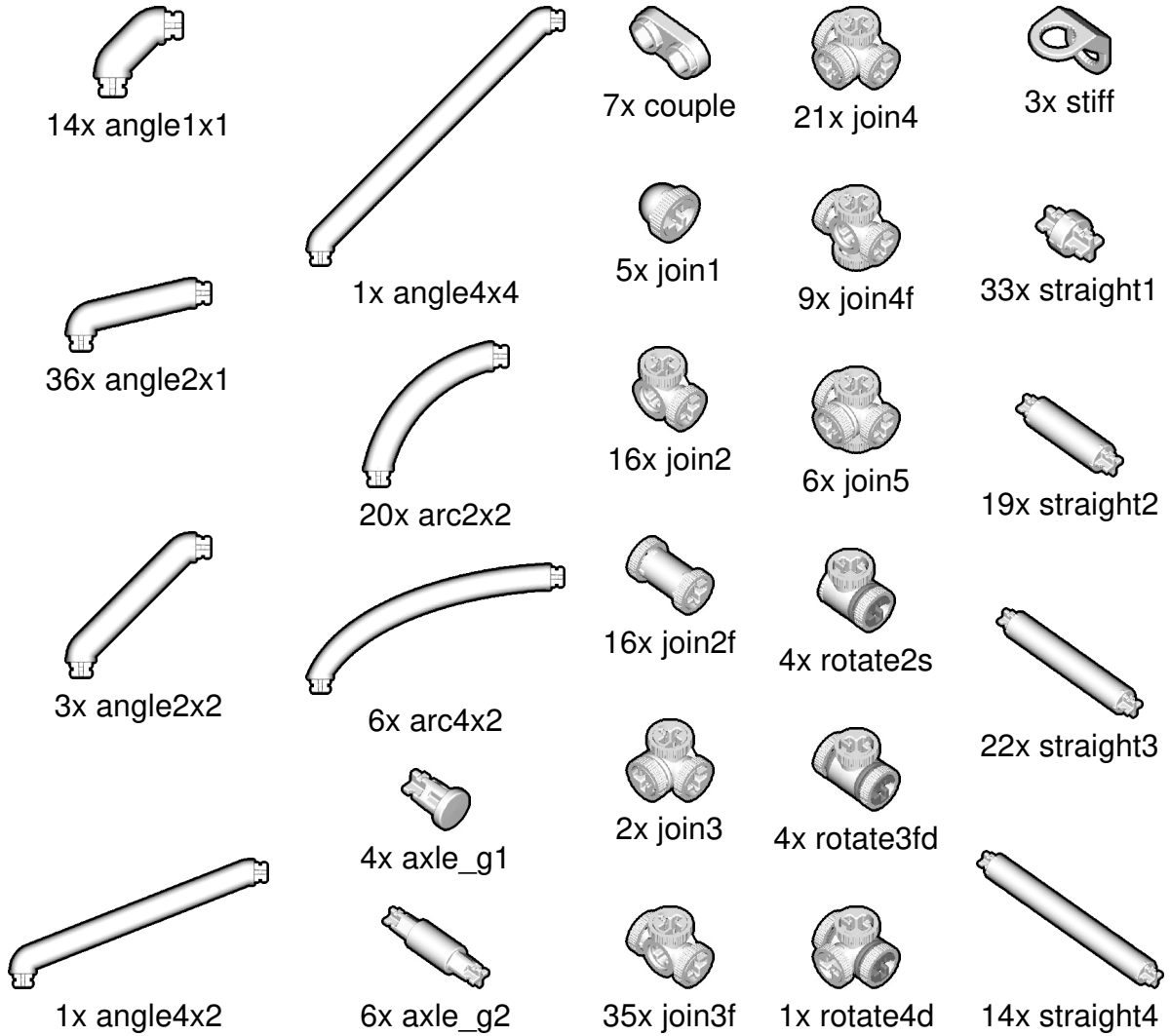

ACTUAL SIZE

