

# ELEPHANT

SIZE  
1.8ft x 1.0ft x 0.7ft

PIECES  
346

DESIGNER  
Charles Sharman

MADE IN  
U.S.A.



Wrong  
Connecting/Disconnecting Two Directions



Right  
Connecting/Disconnecting One Direction

1

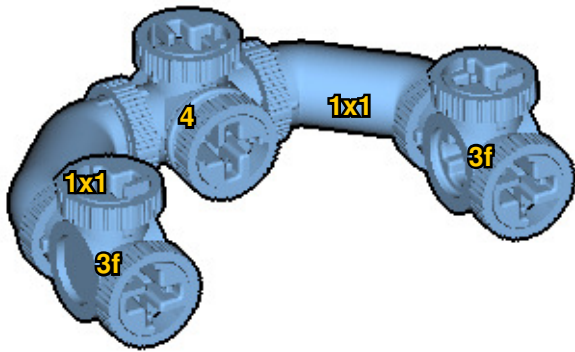

New pieces are drawn blue. Old pieces are drawn white.  
See back for piece names.

2

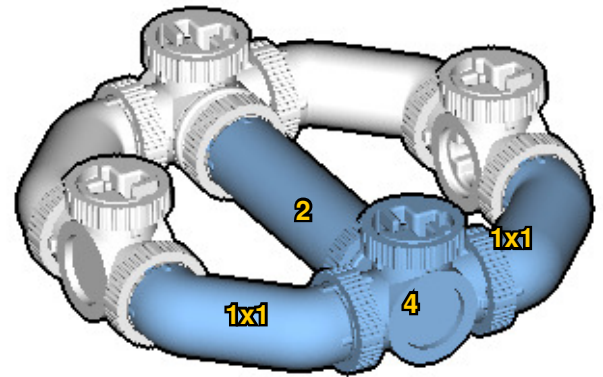

Connect new pieces together before connecting to old pieces.

3

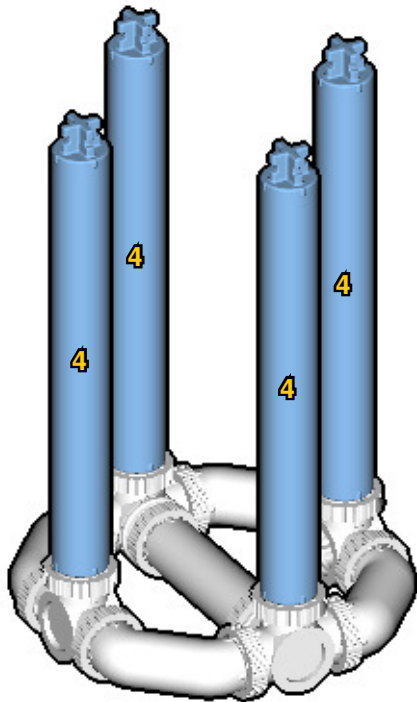

Submodel begins → **4**

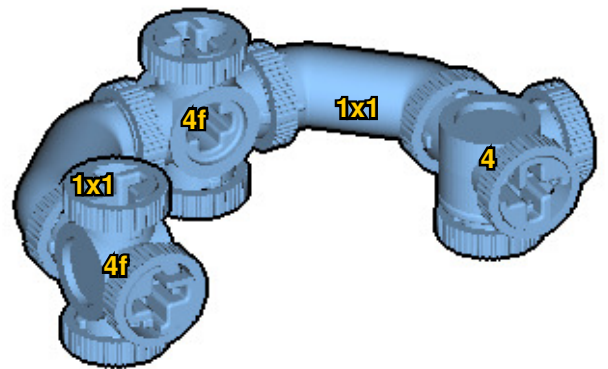

5

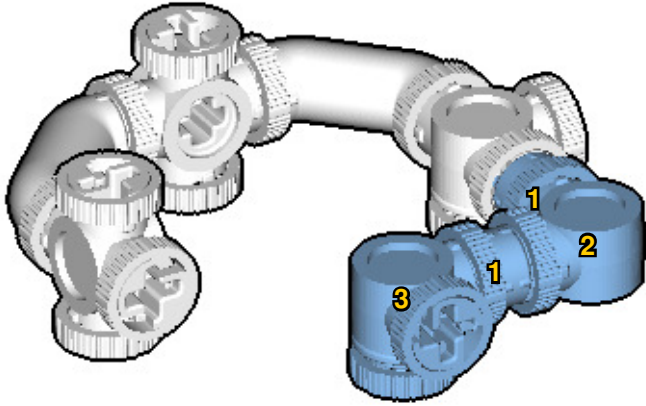

Submodel ends → 6

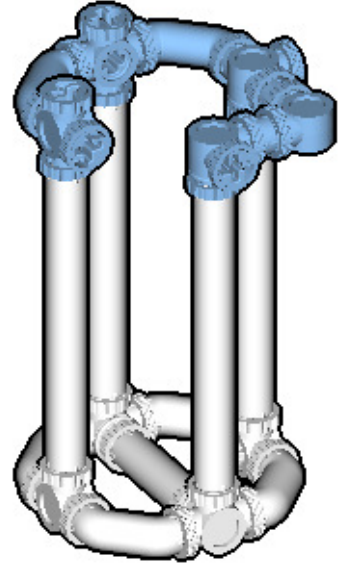

Connect submodel to model.

7

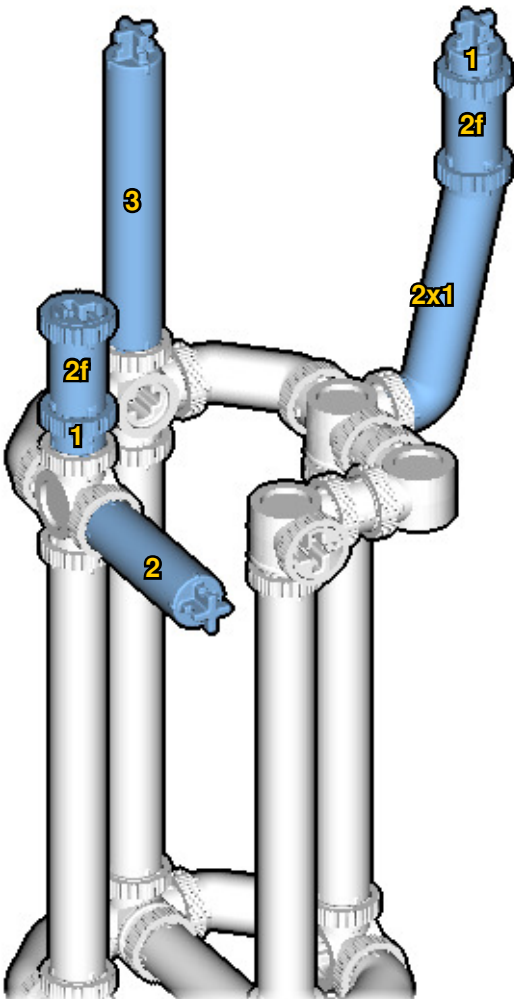

8

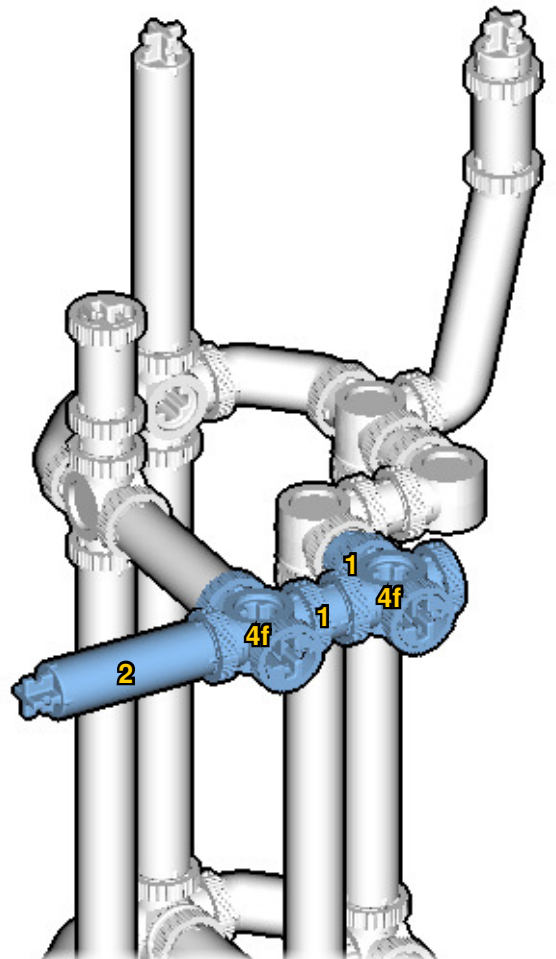

9

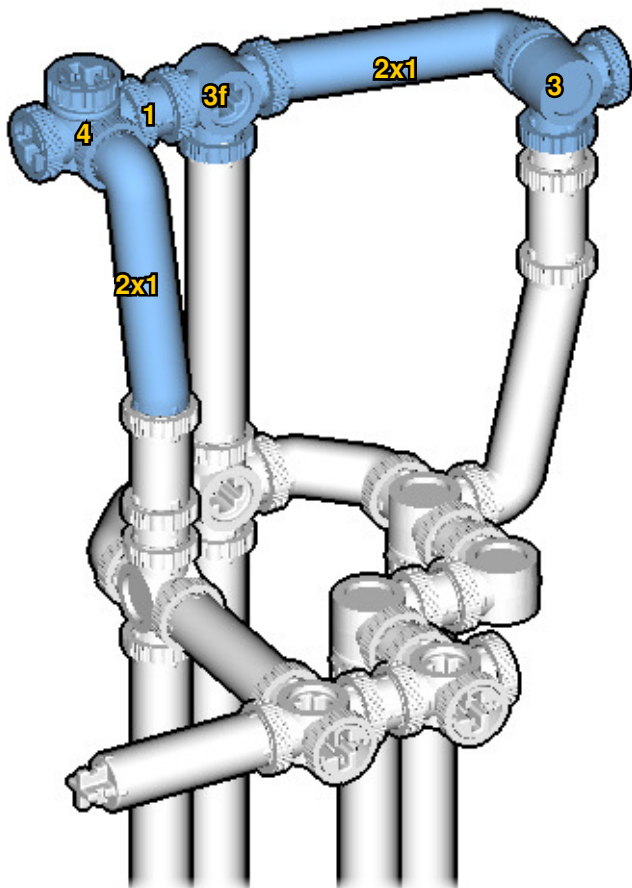

10

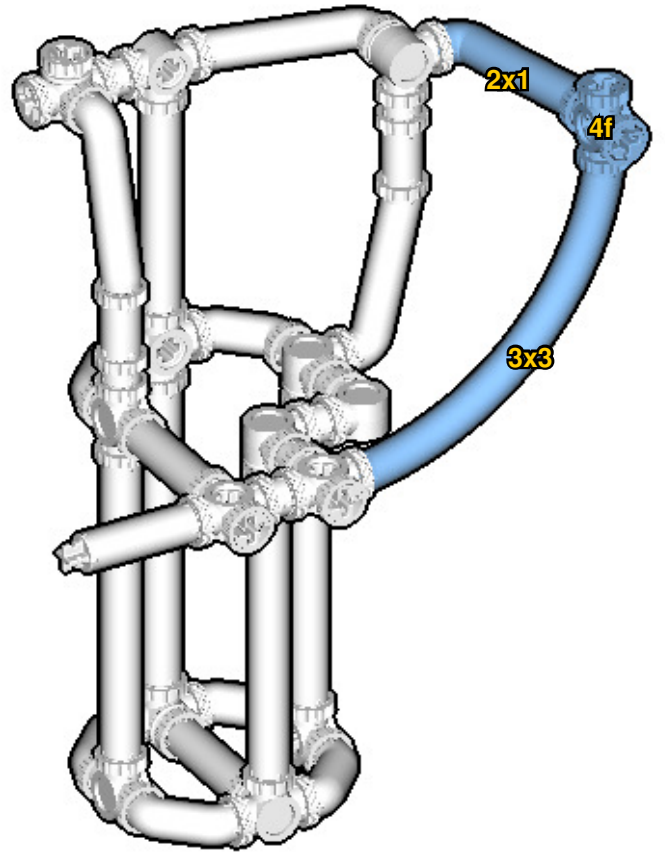

11

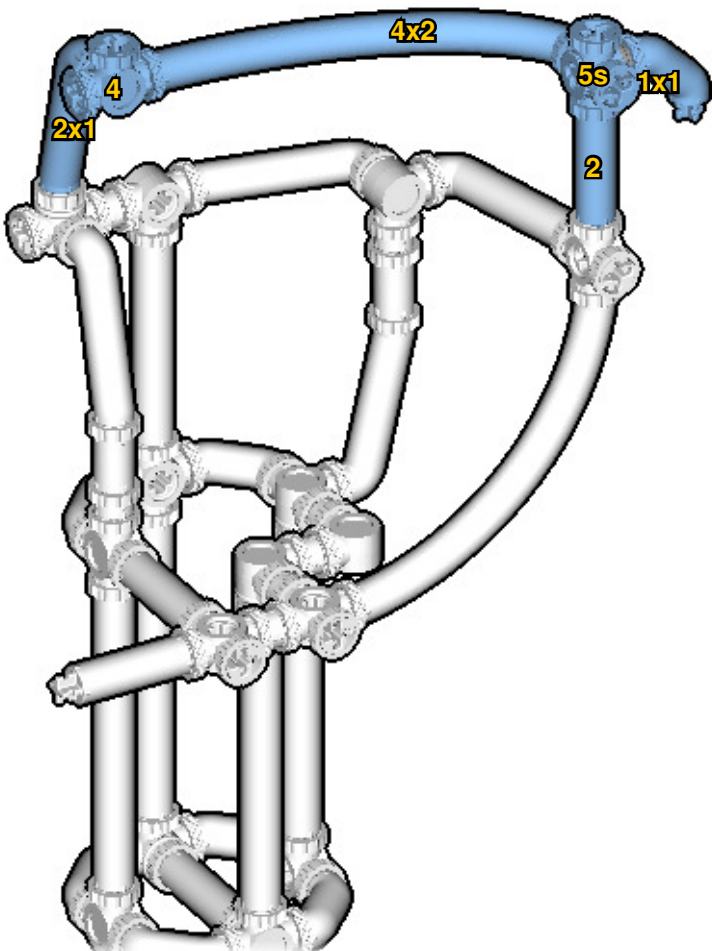

12

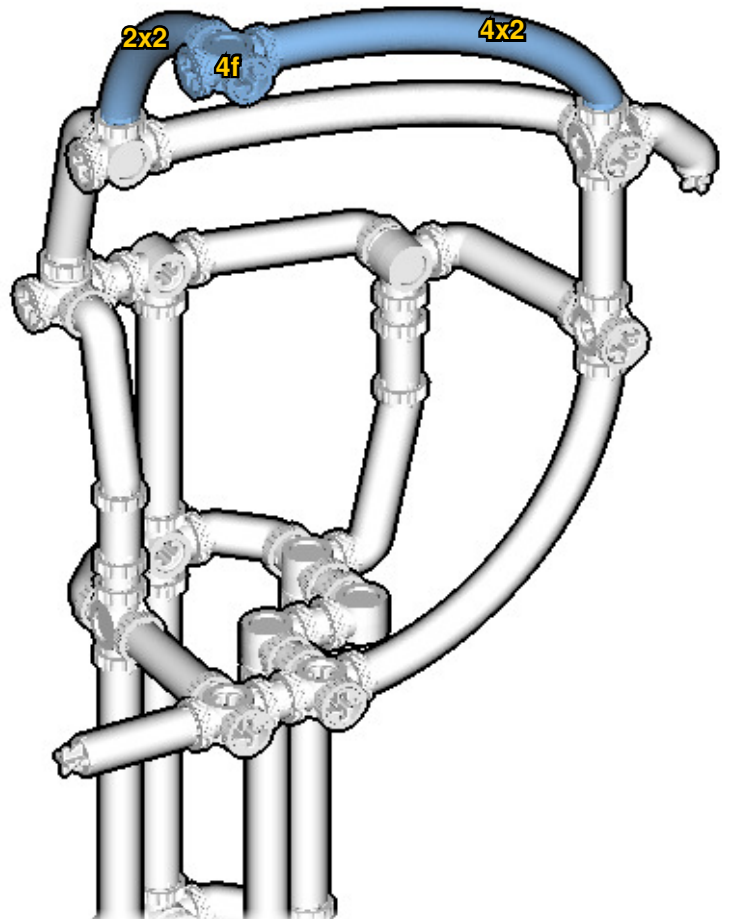

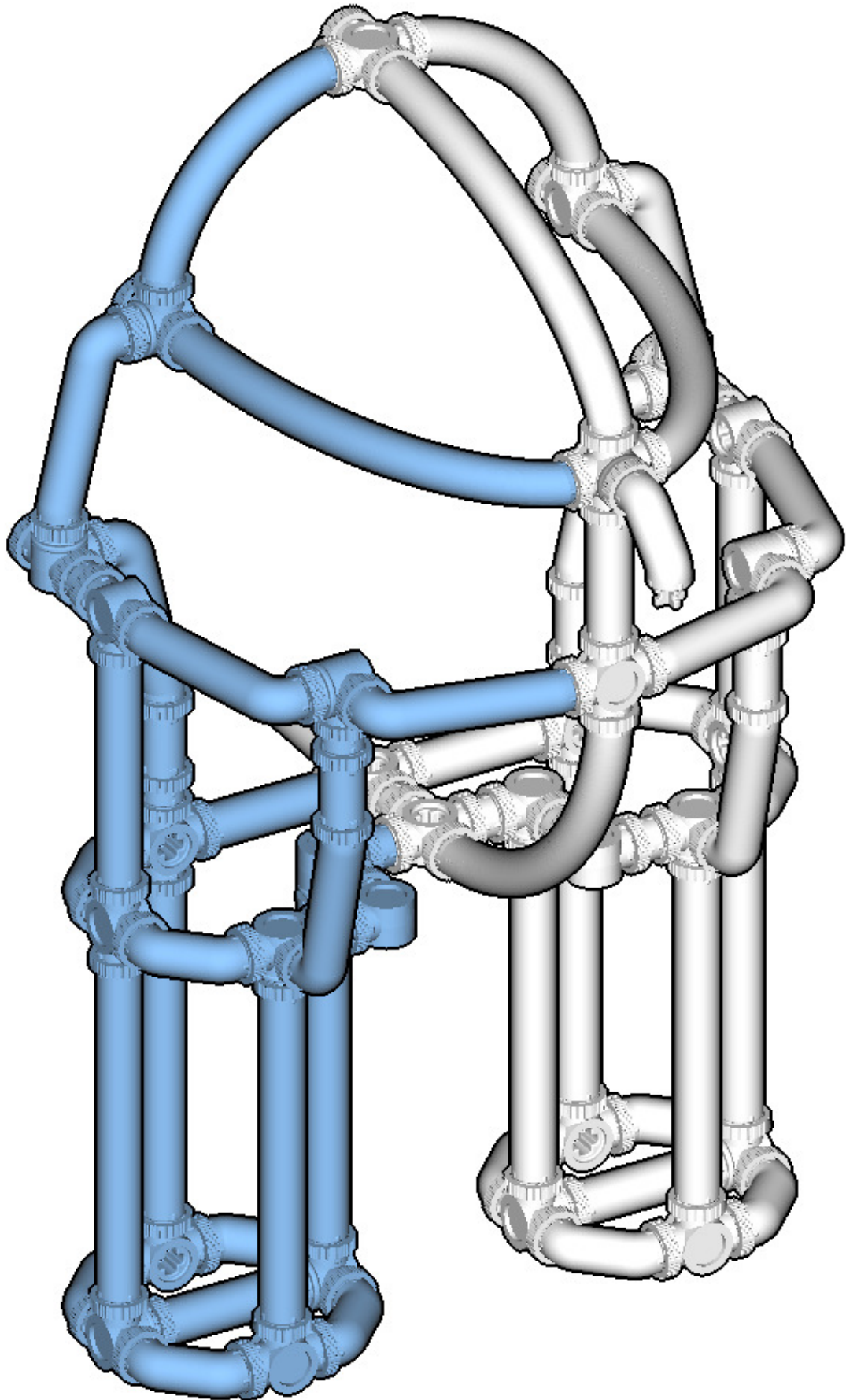
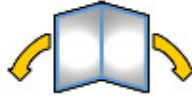

 : Copy new pieces from old pieces.

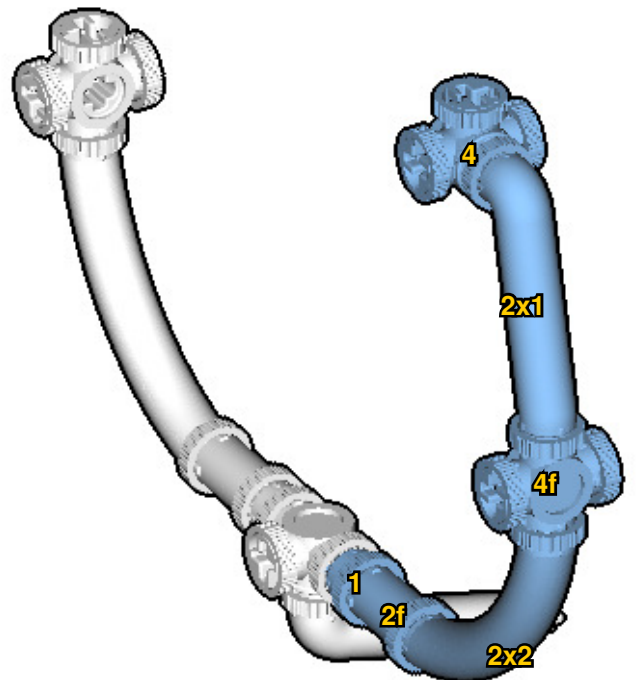
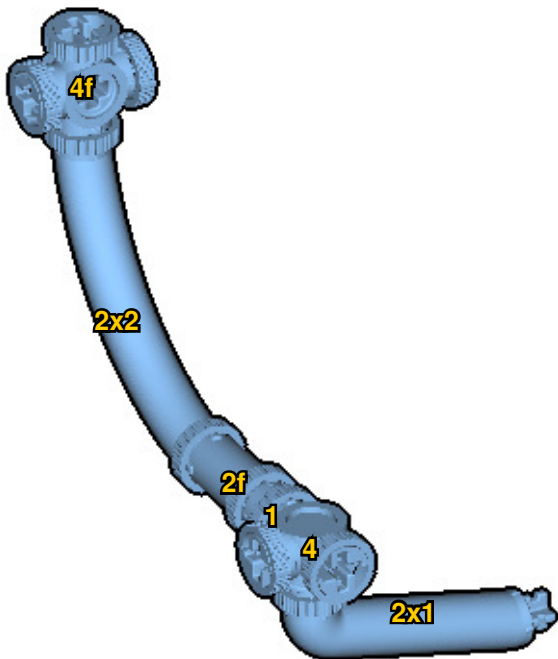
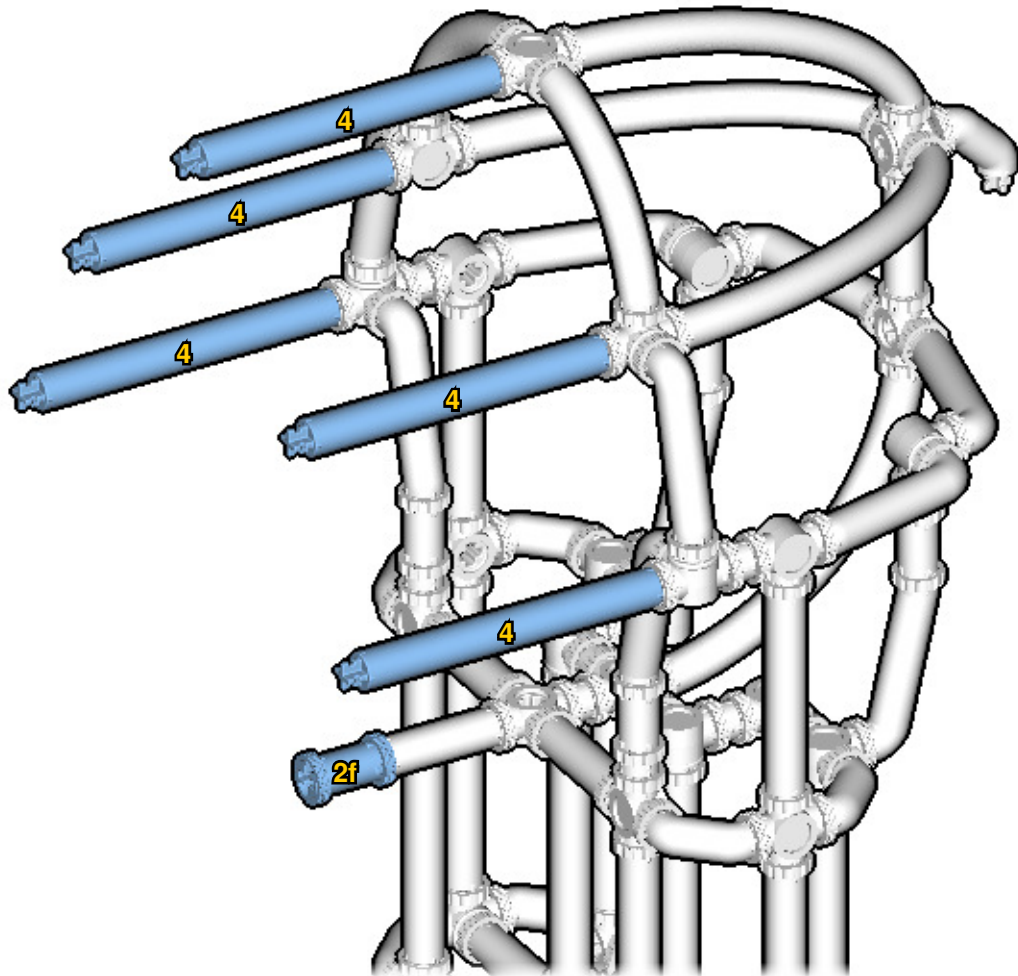

**17**

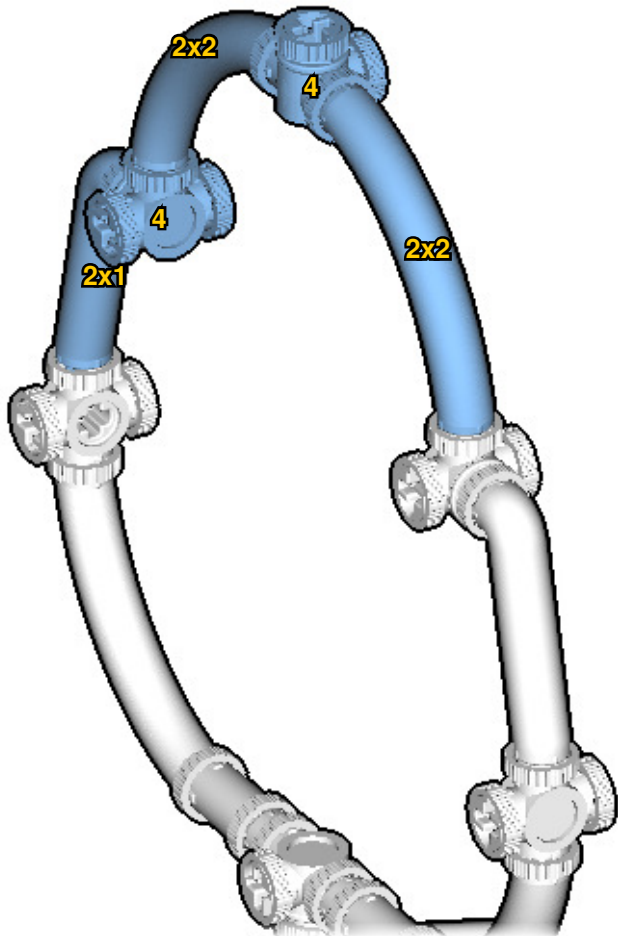

**18**

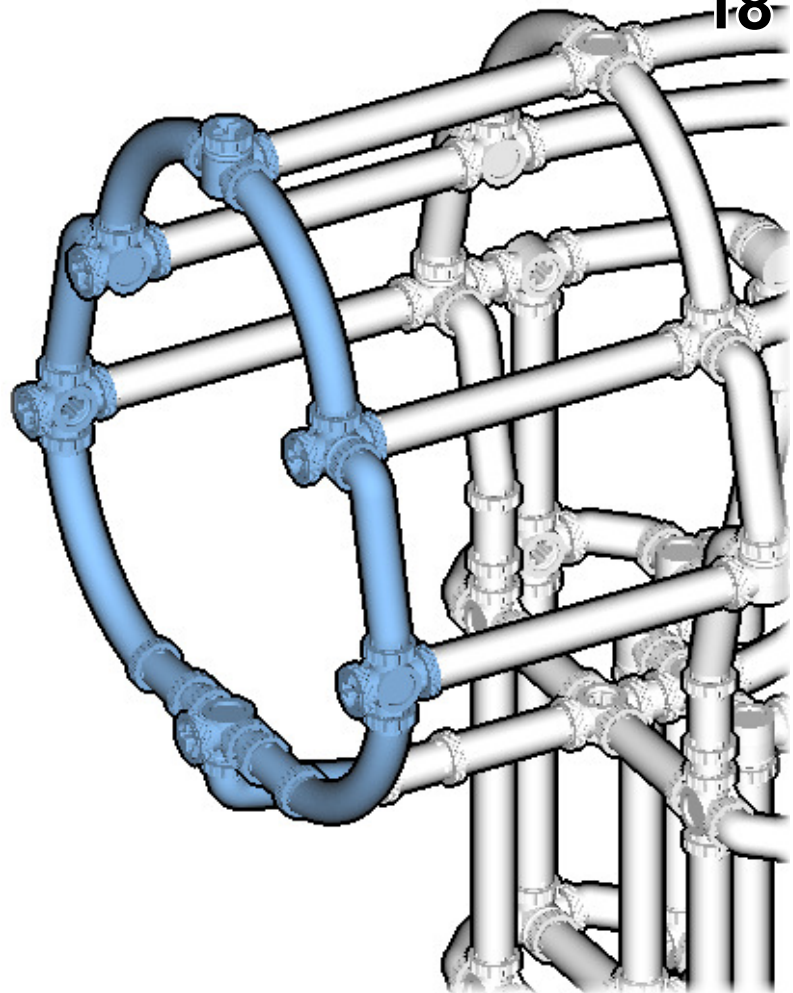

**19**

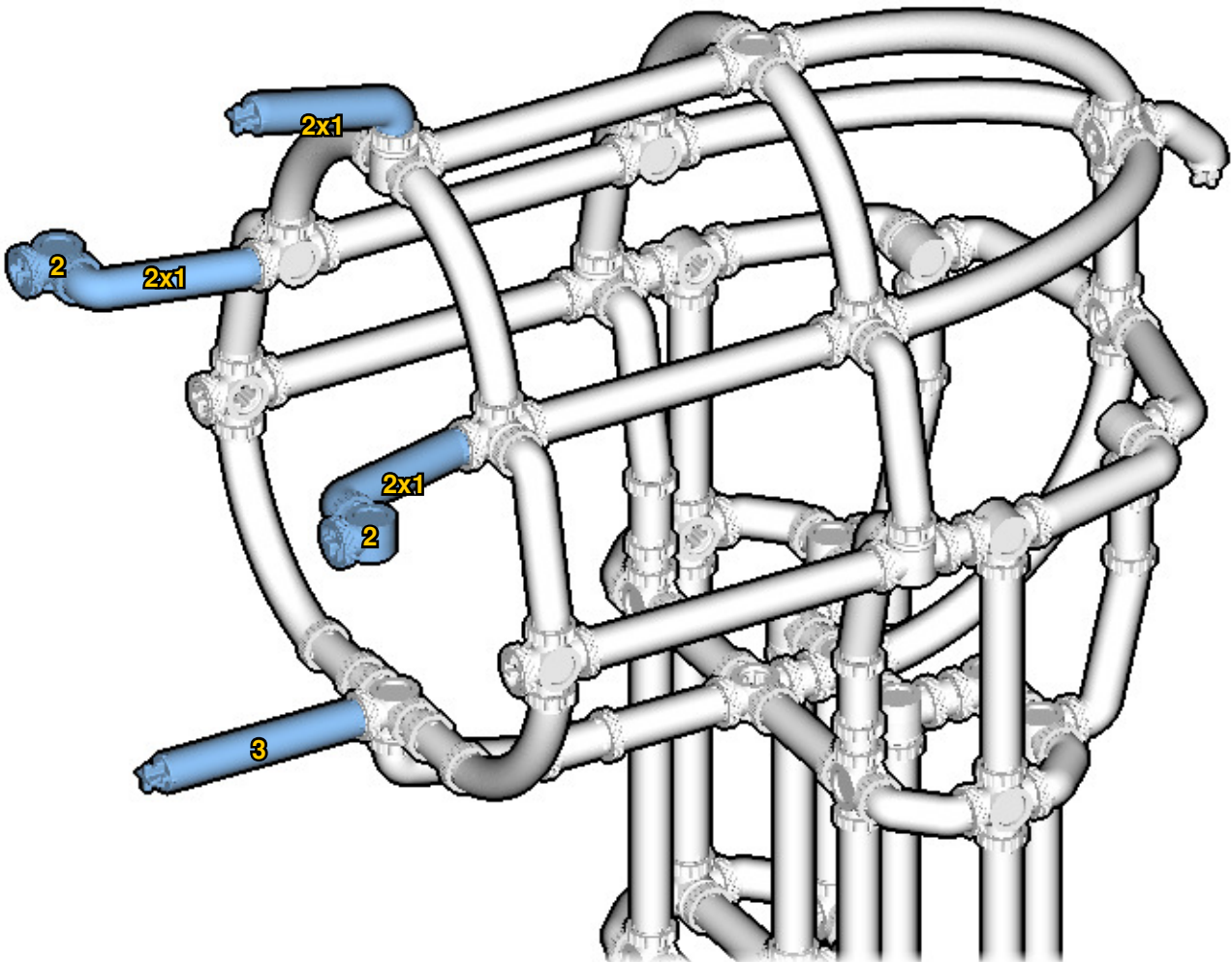



20

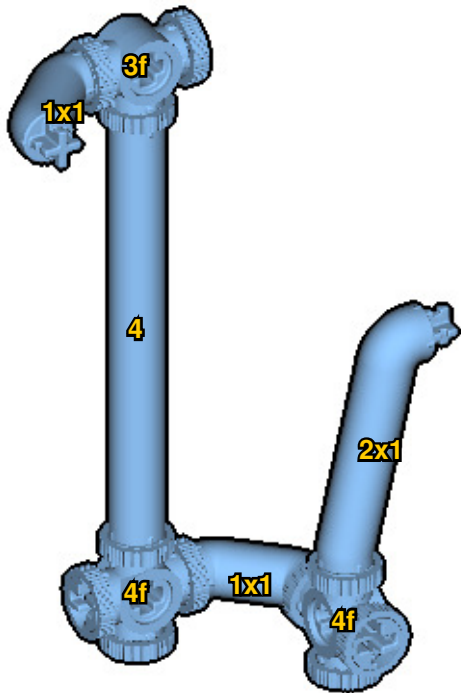

21

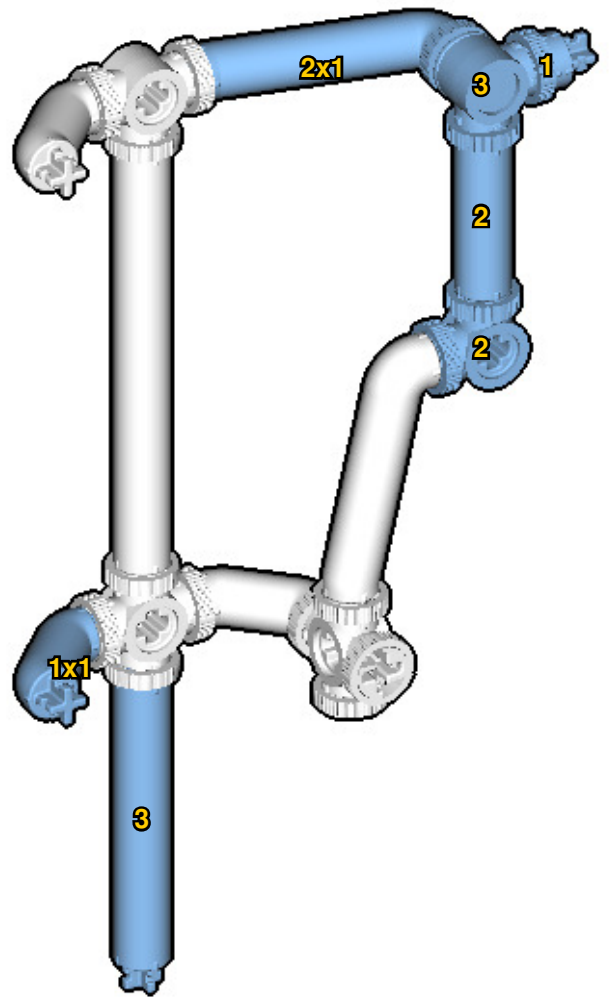

22

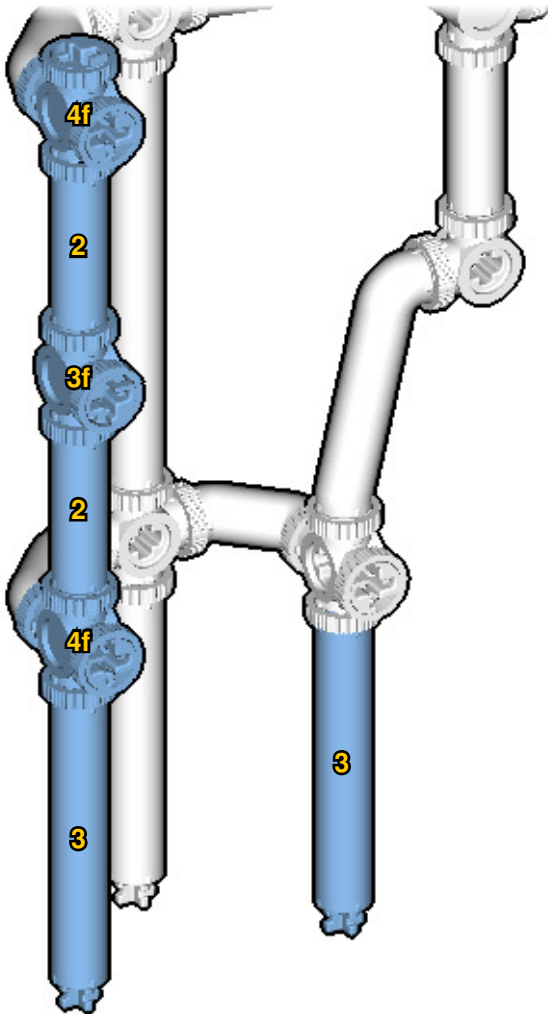

23

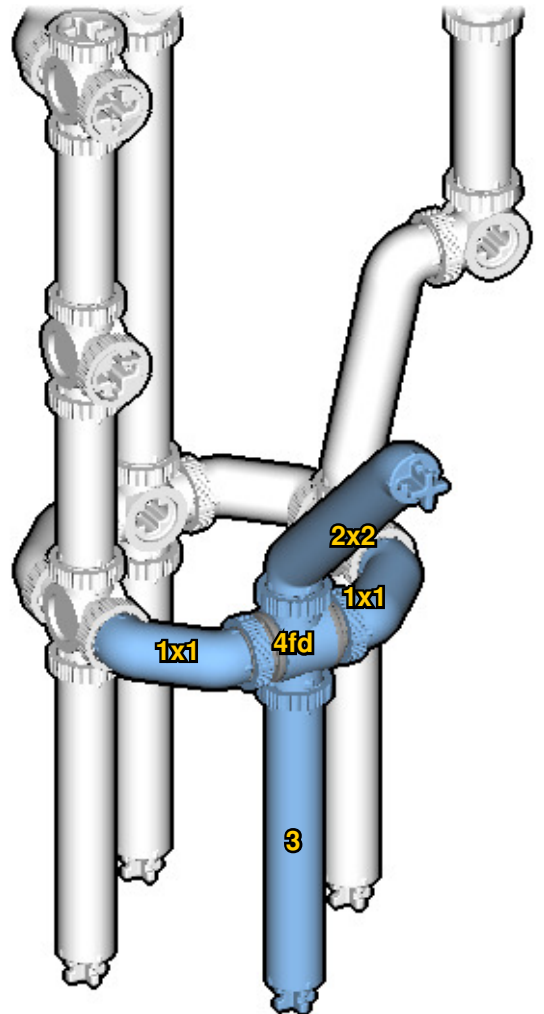

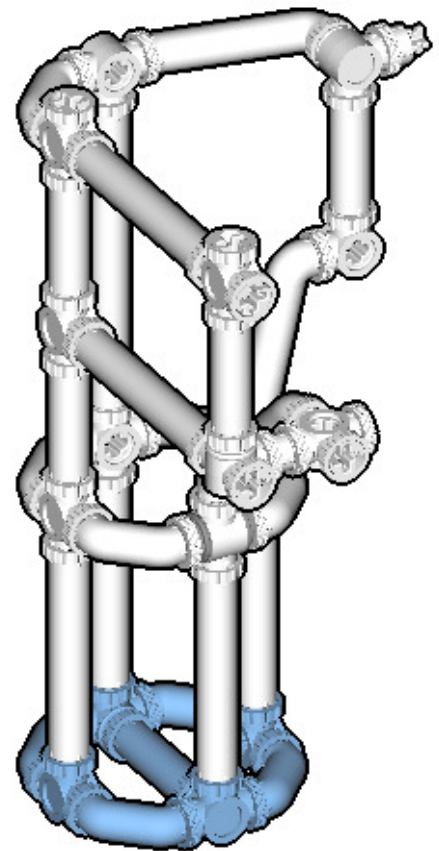
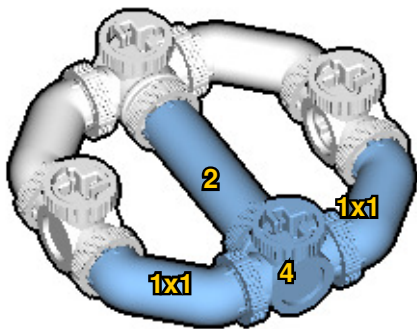
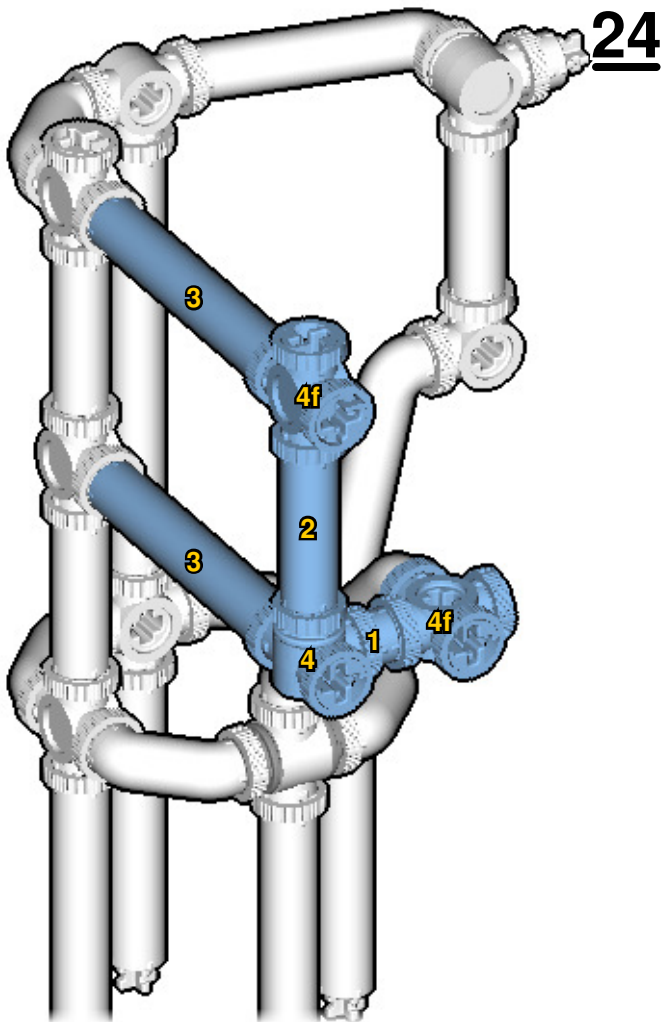

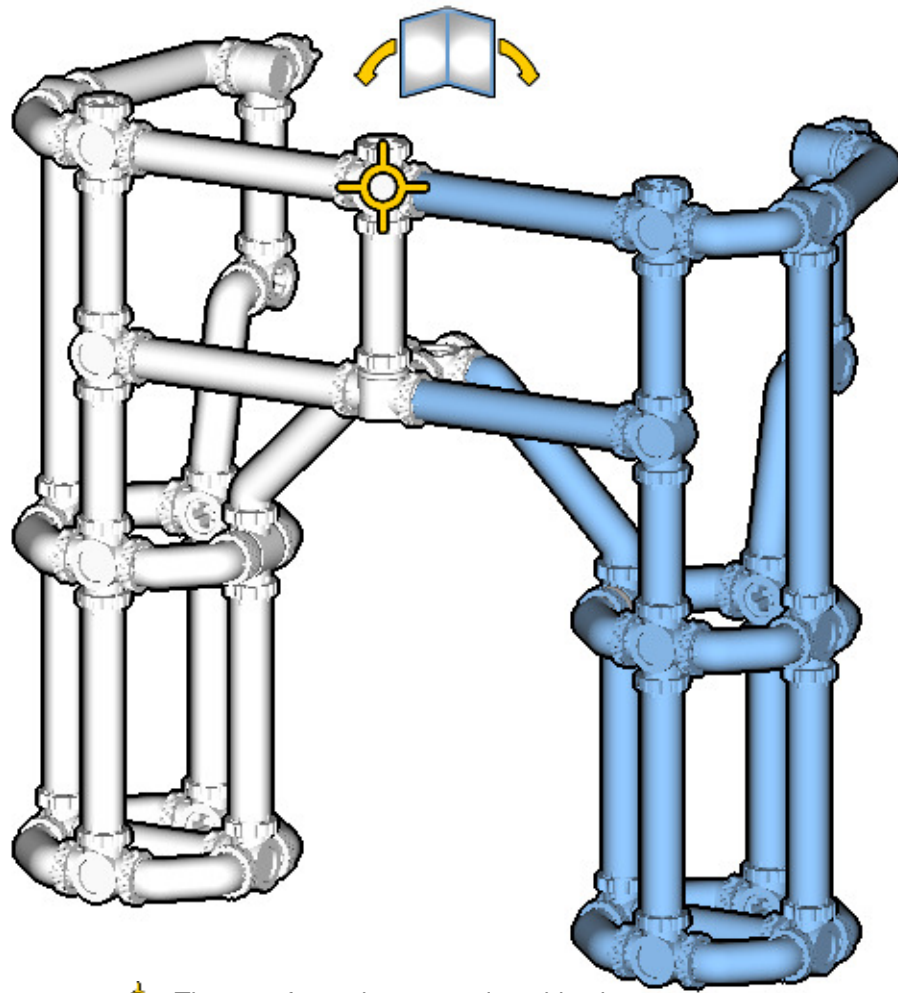

★ : The next frame is centered on this piece.

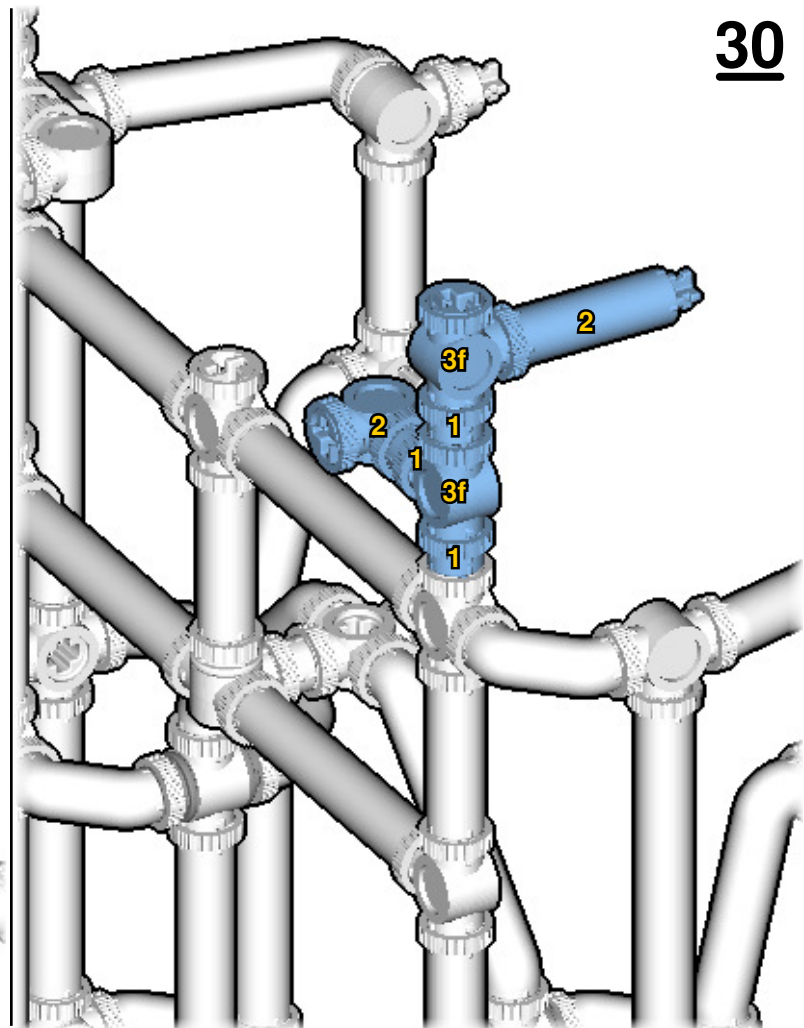
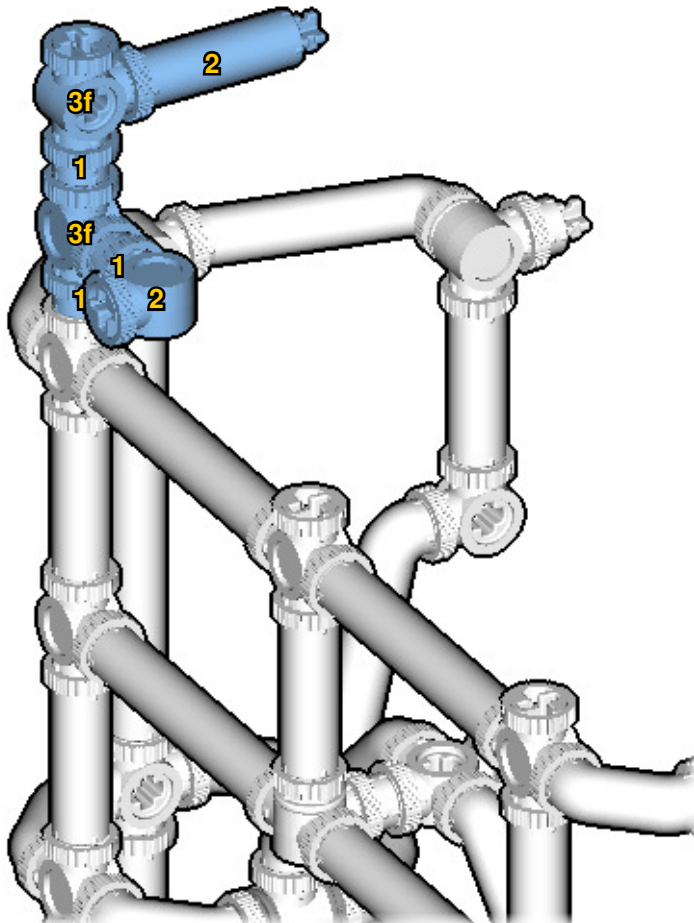

**31**

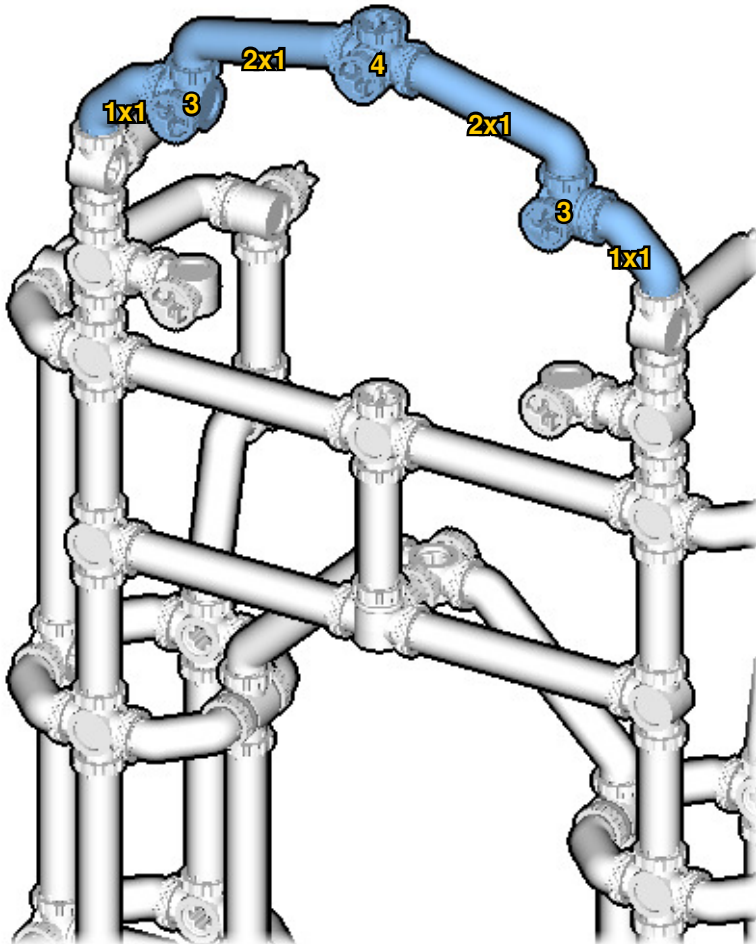

**32**

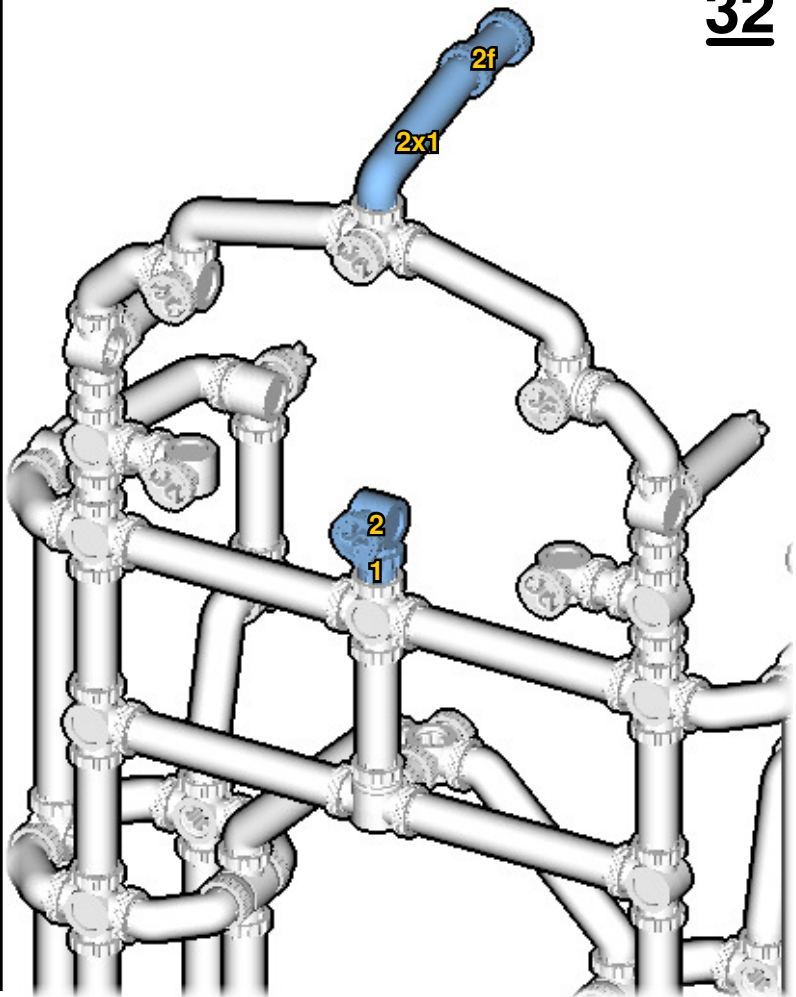

**33**

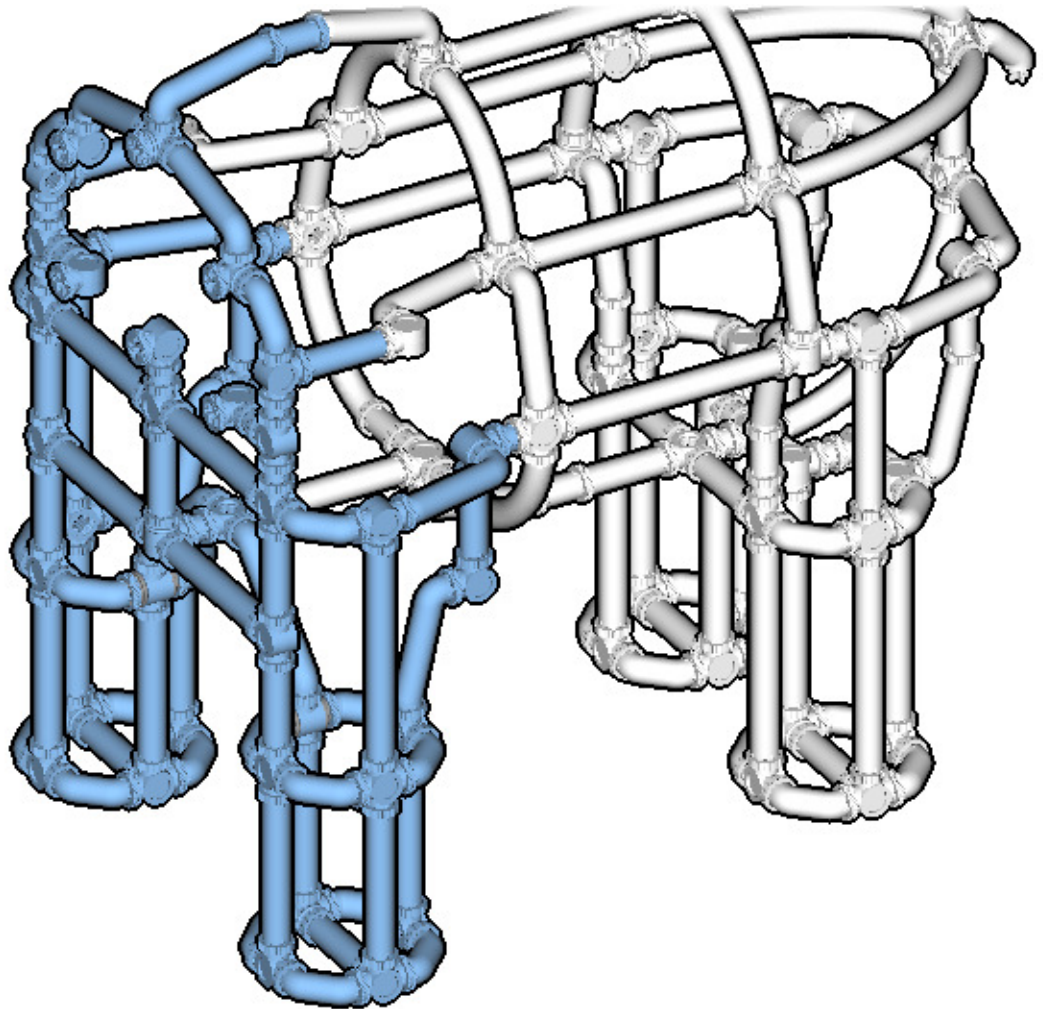

34

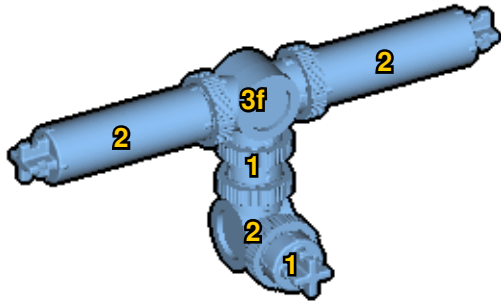

35

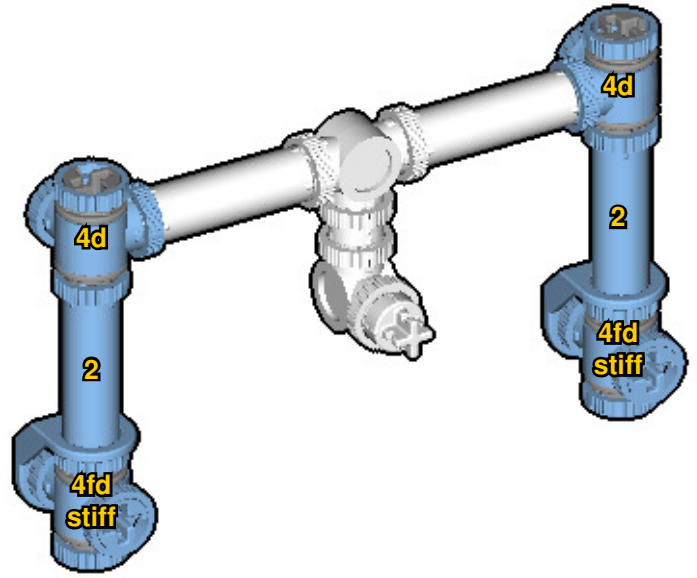

36

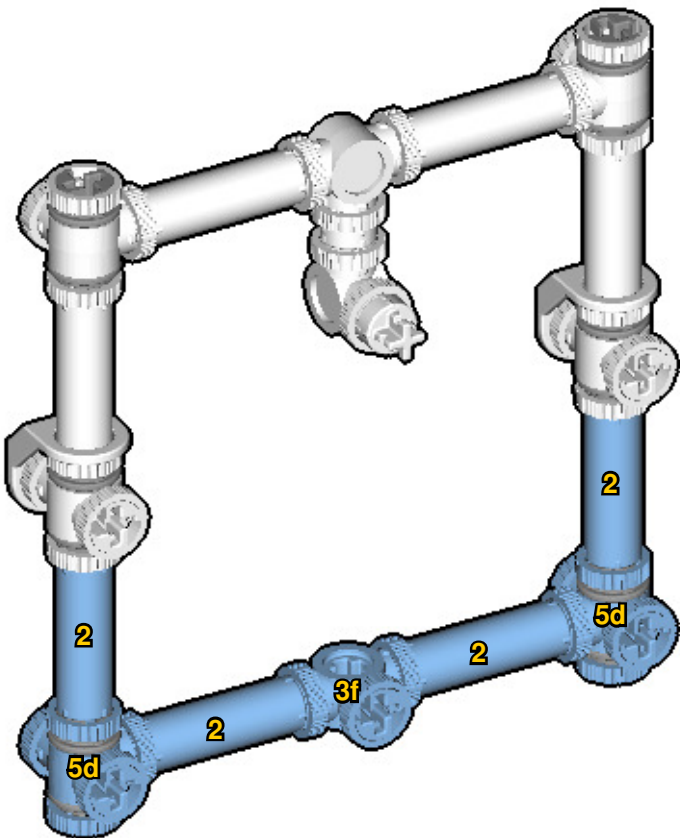

37

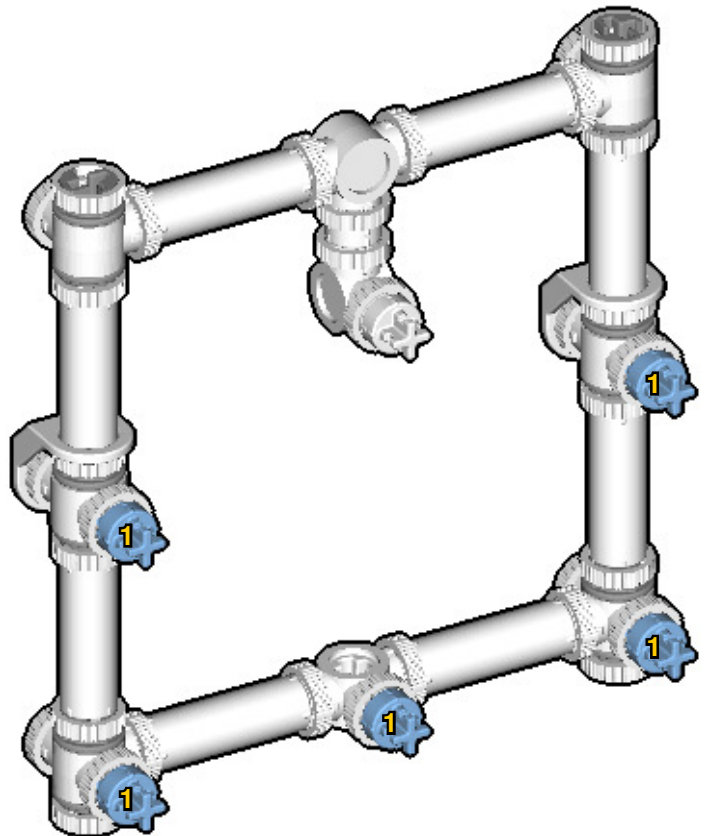

38

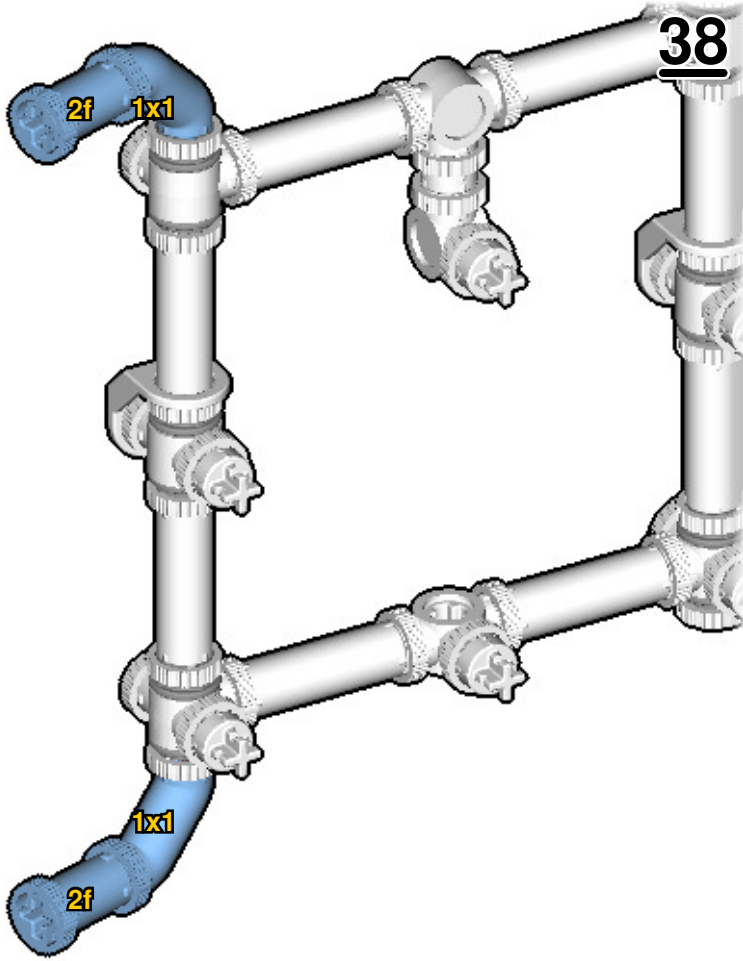

39

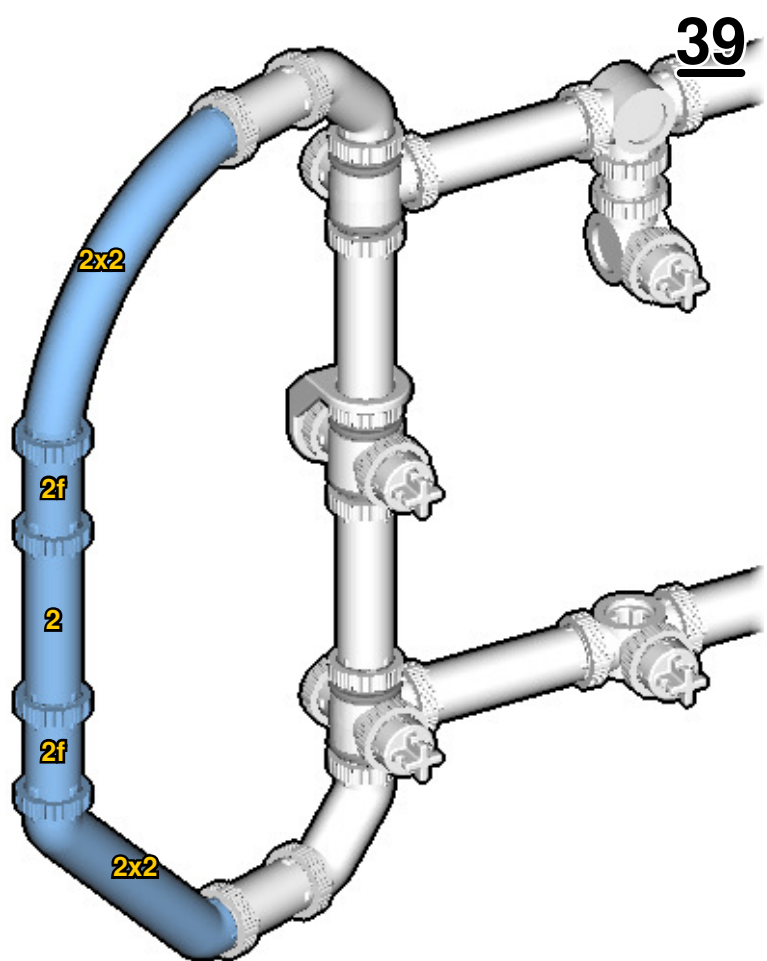

40

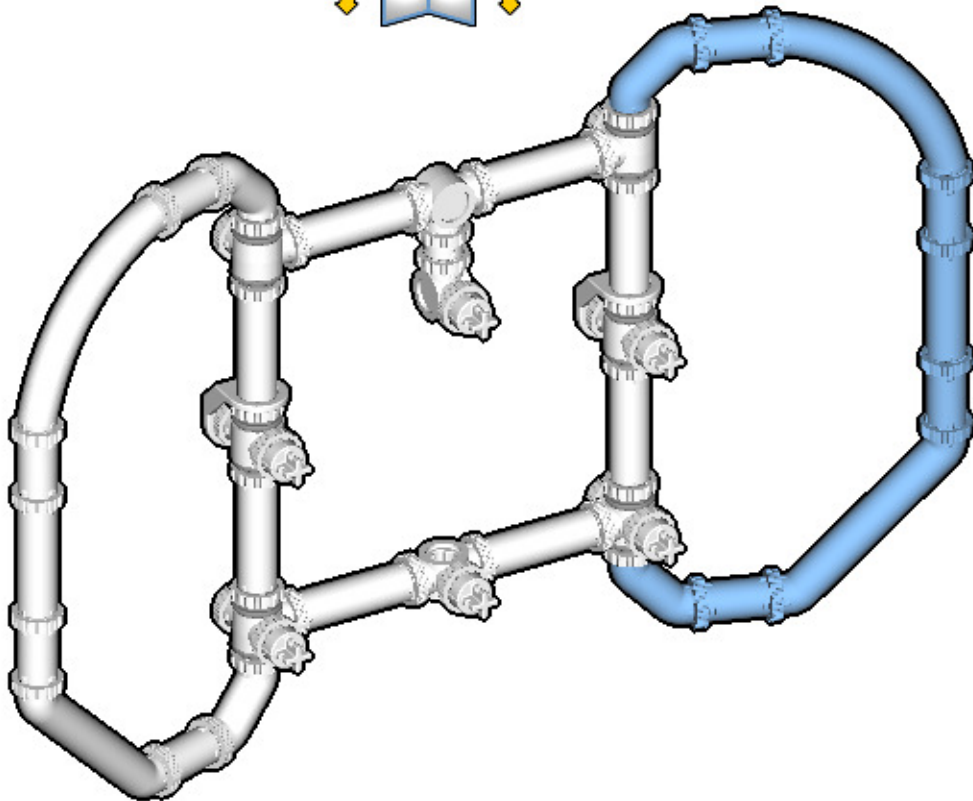
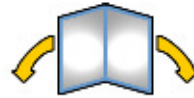

41

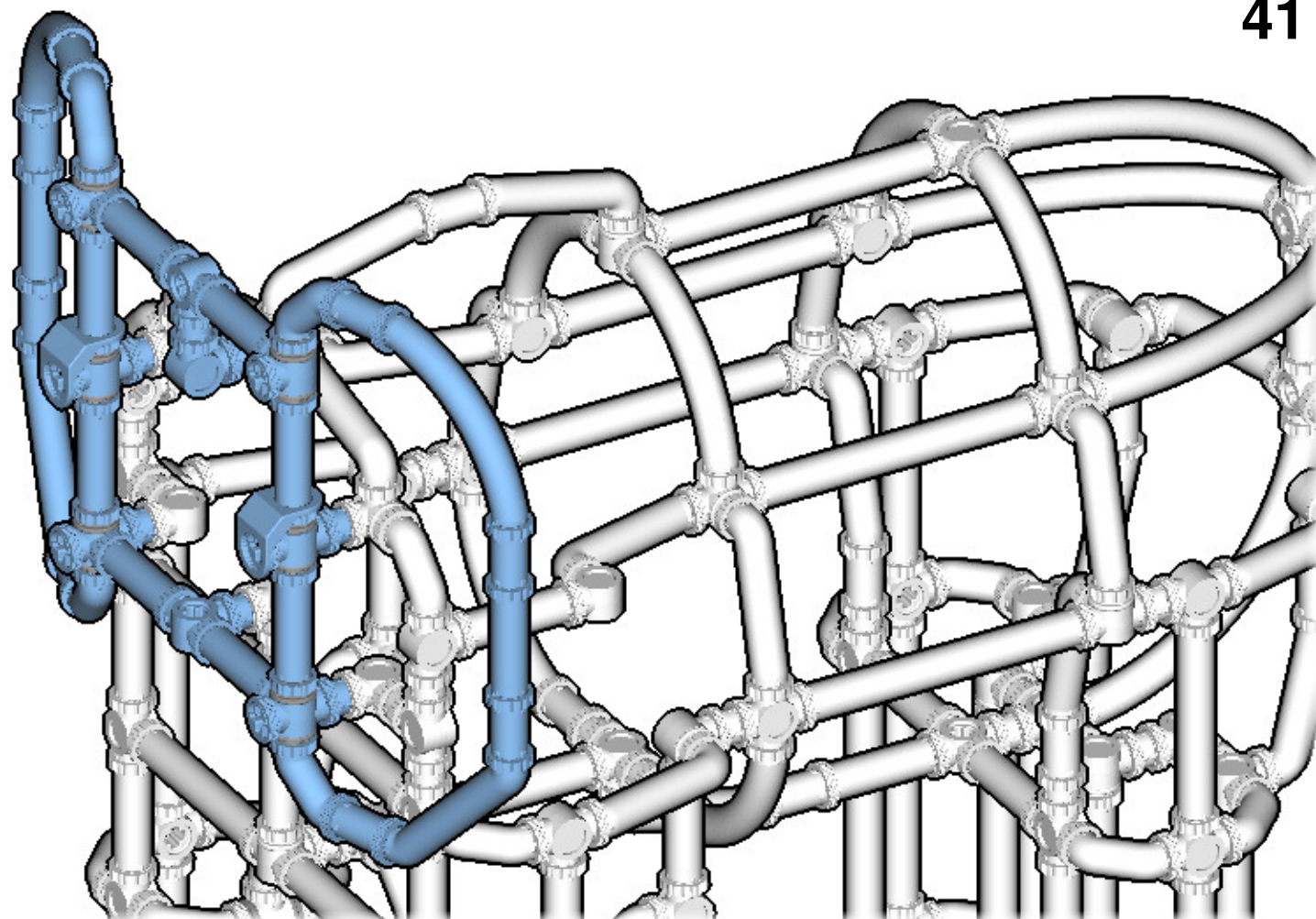

42

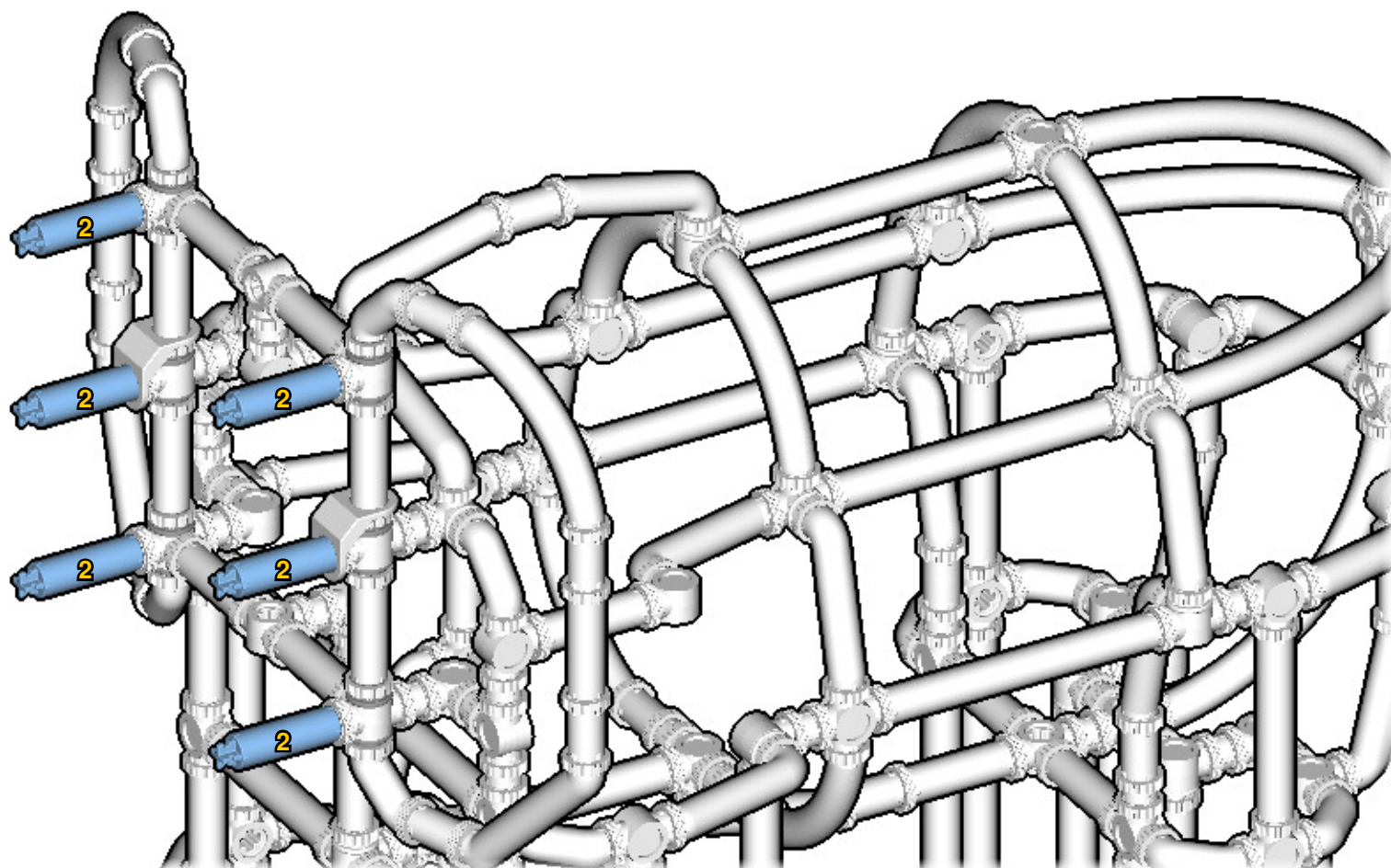

43



44

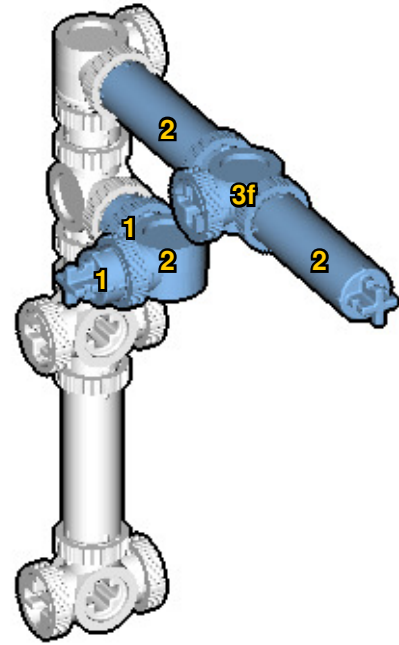

45

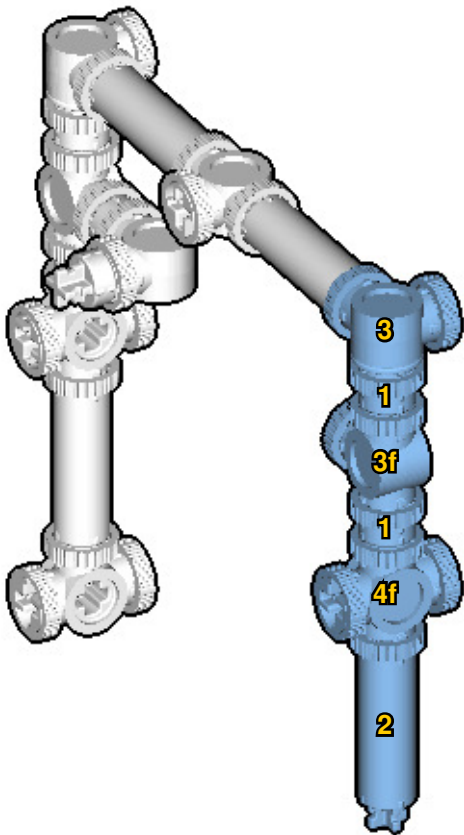

46

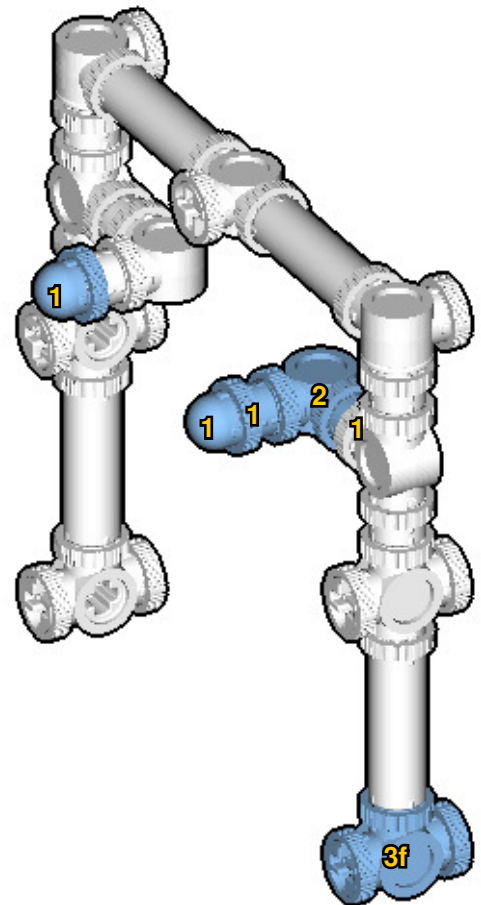



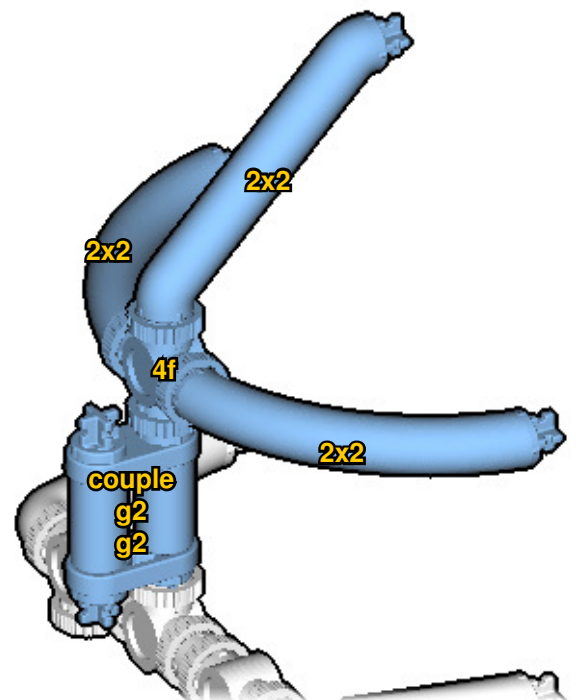
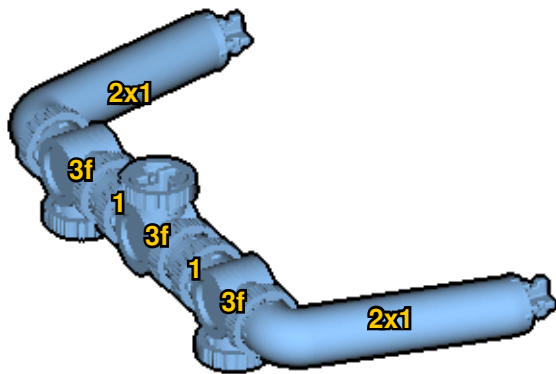
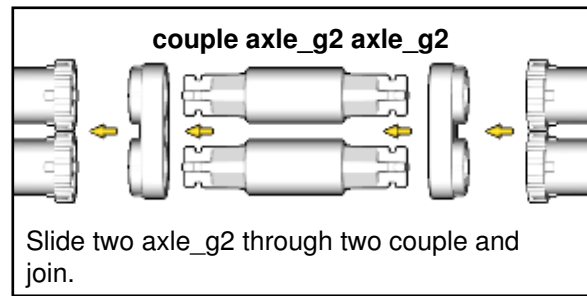
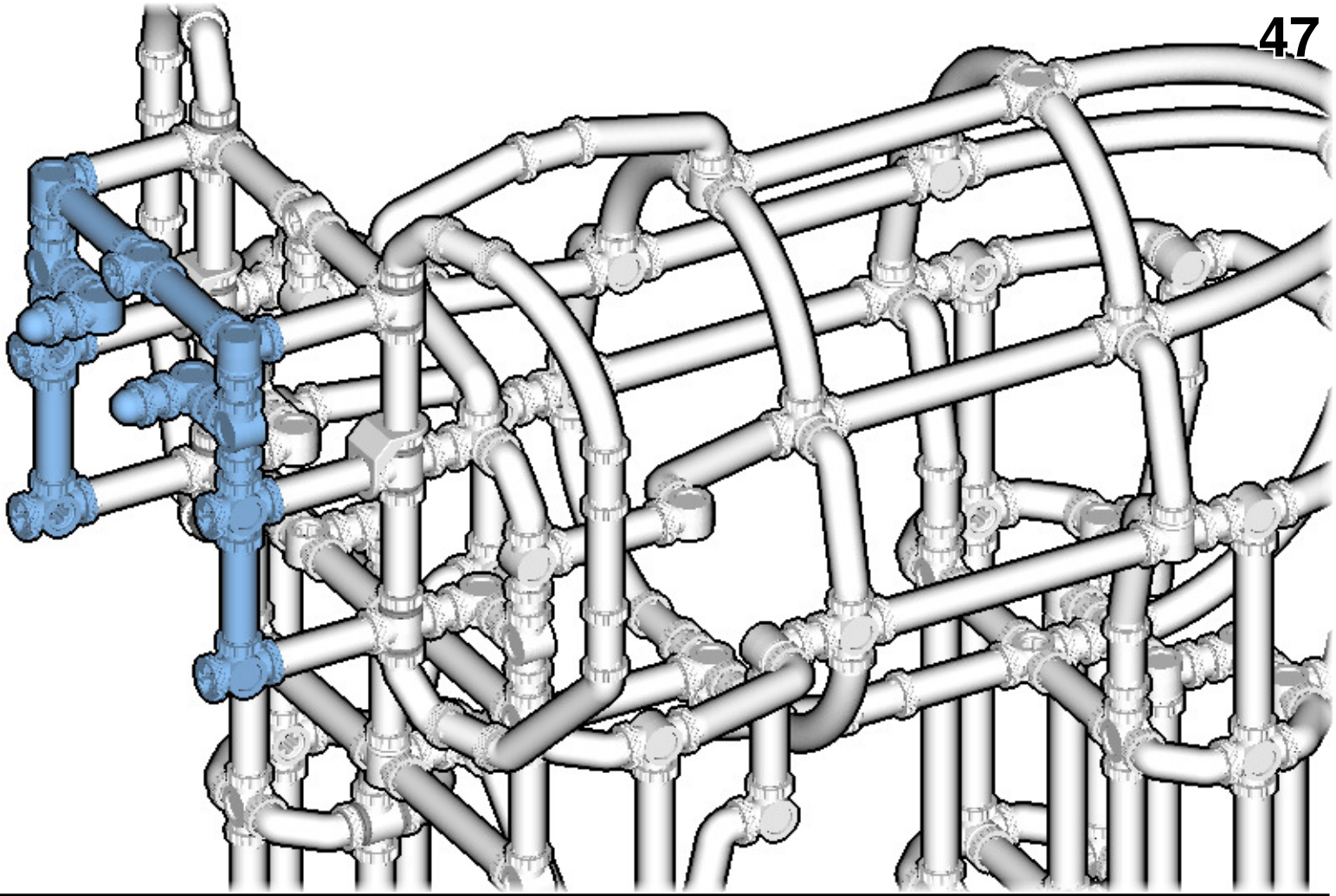

50

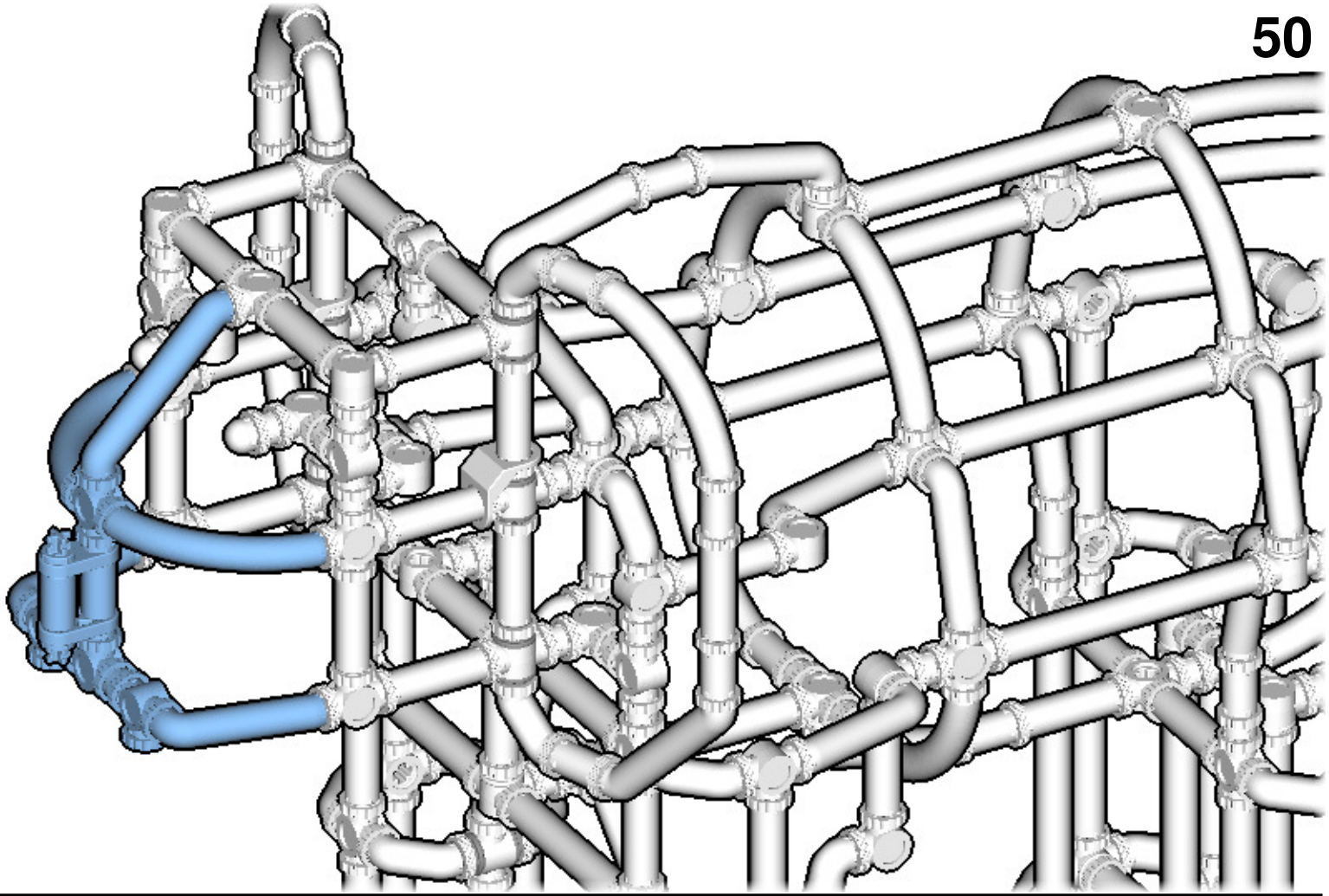

51

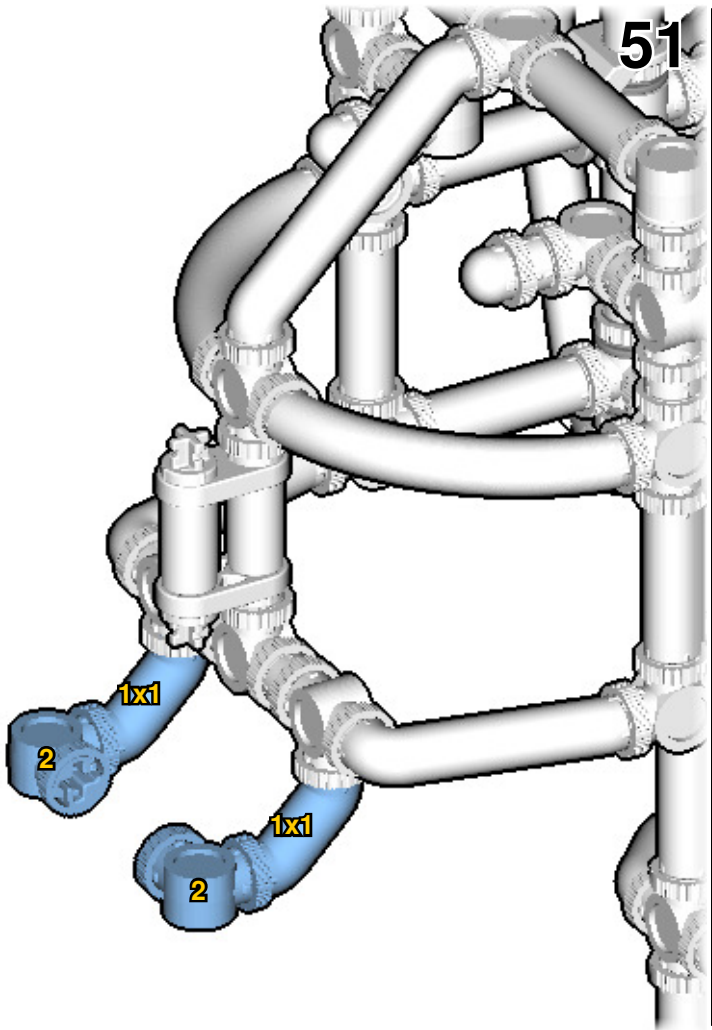

52

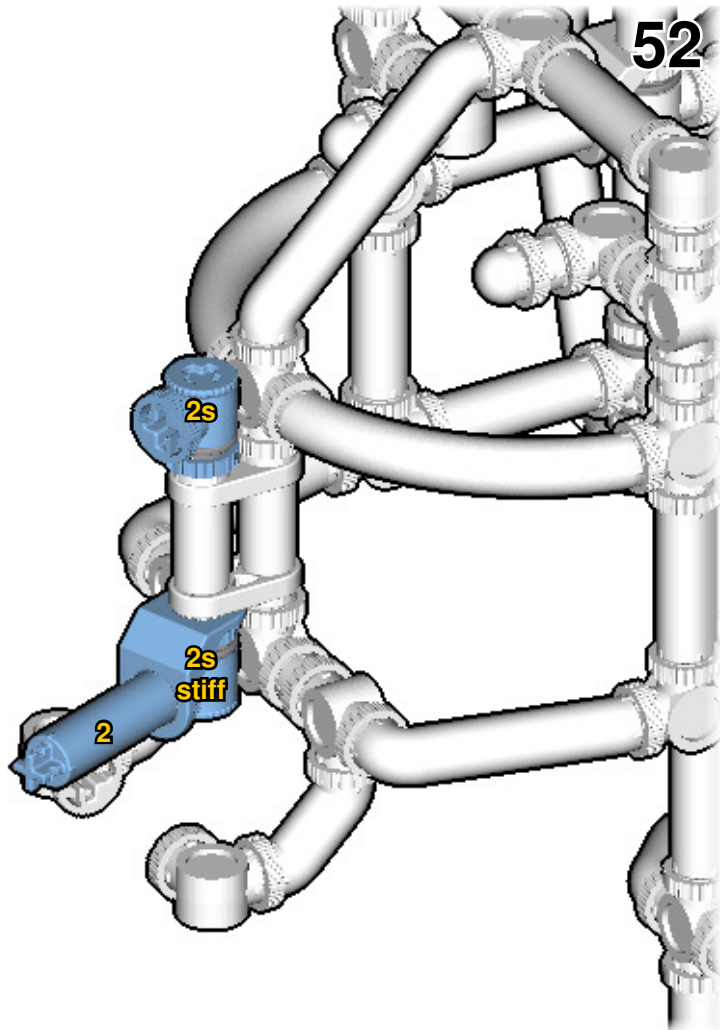

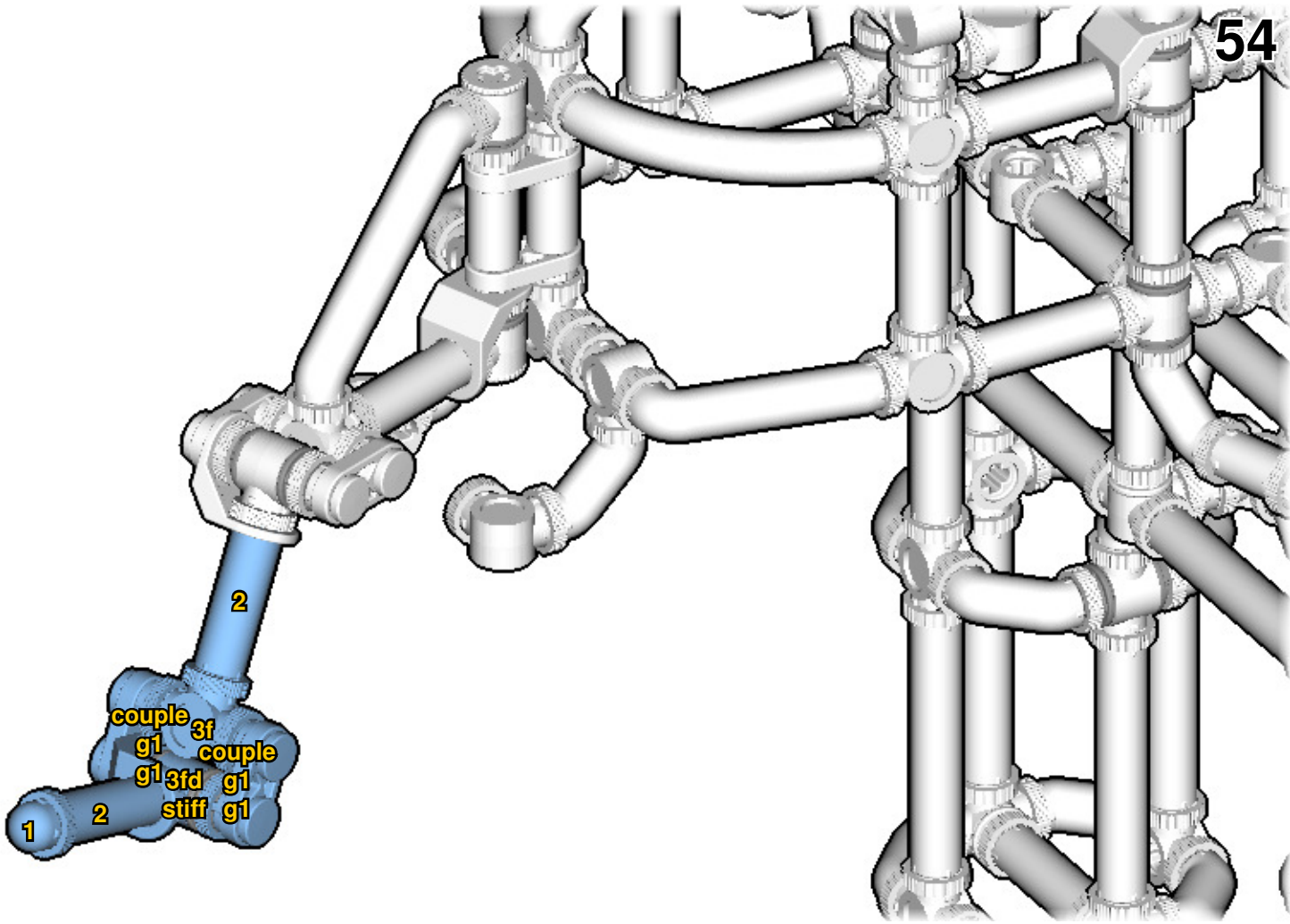
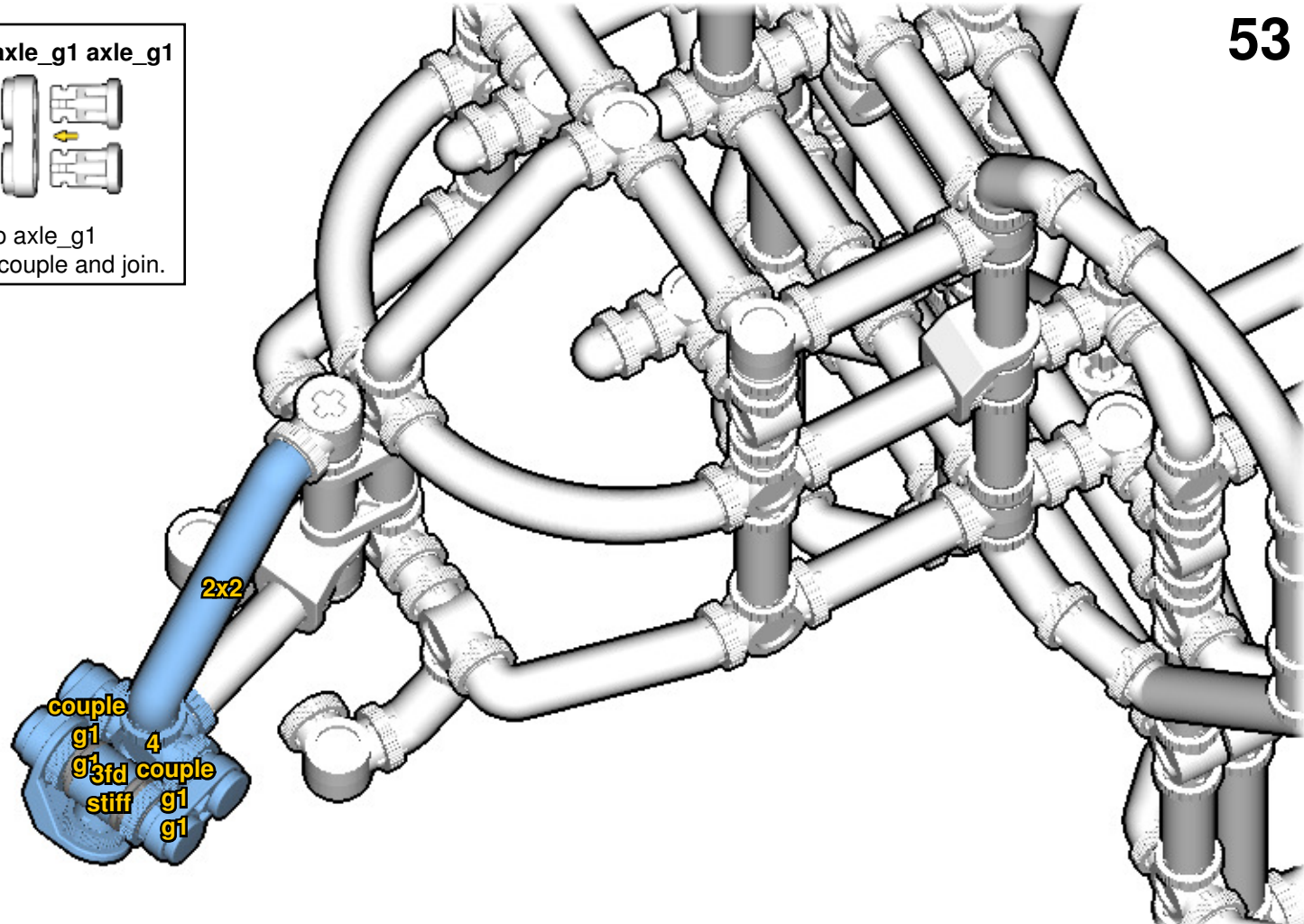
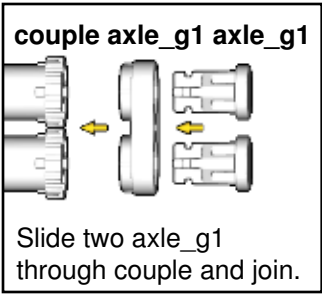

# INVENTORY

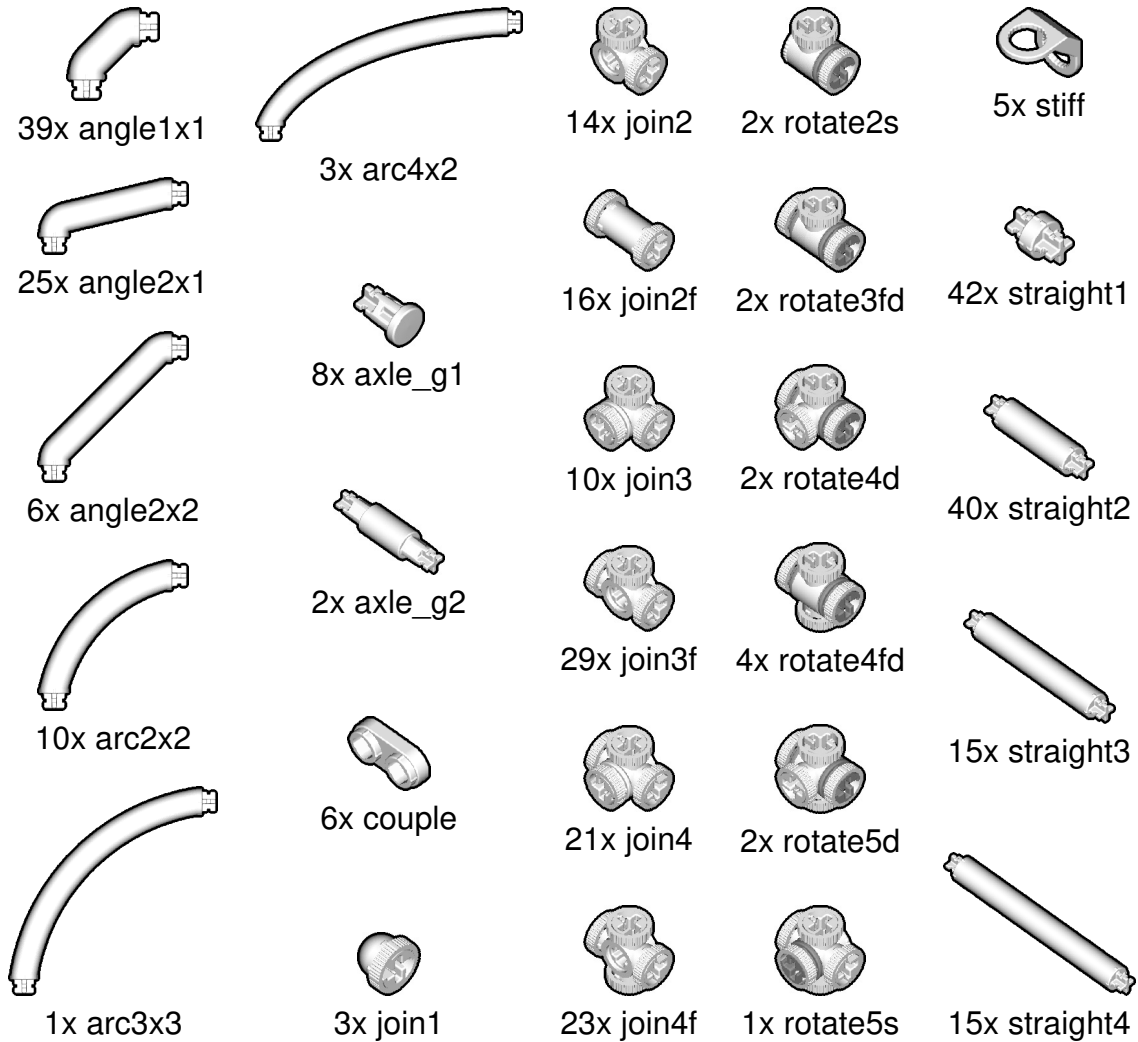

# ACTUAL SIZE

