

SIZE	2.0ft x 1.9ft x 0.6ft	PIECES	203
DESIGNER	Derek Sharman	MADE IN	U.S.A.

FIGHTER PLANE

⚠ WARNING: Small parts. Age 12+. Handle responsibly. U.S. Patent 9,086,087.

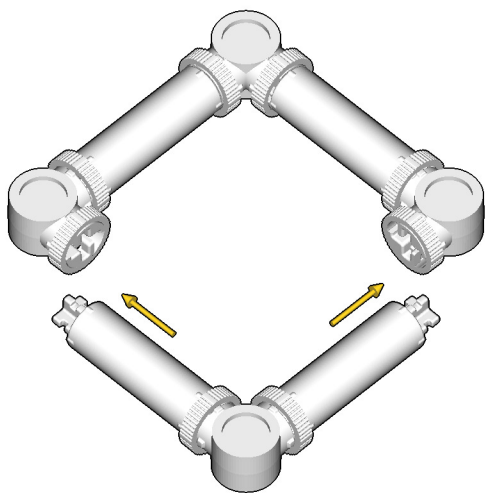
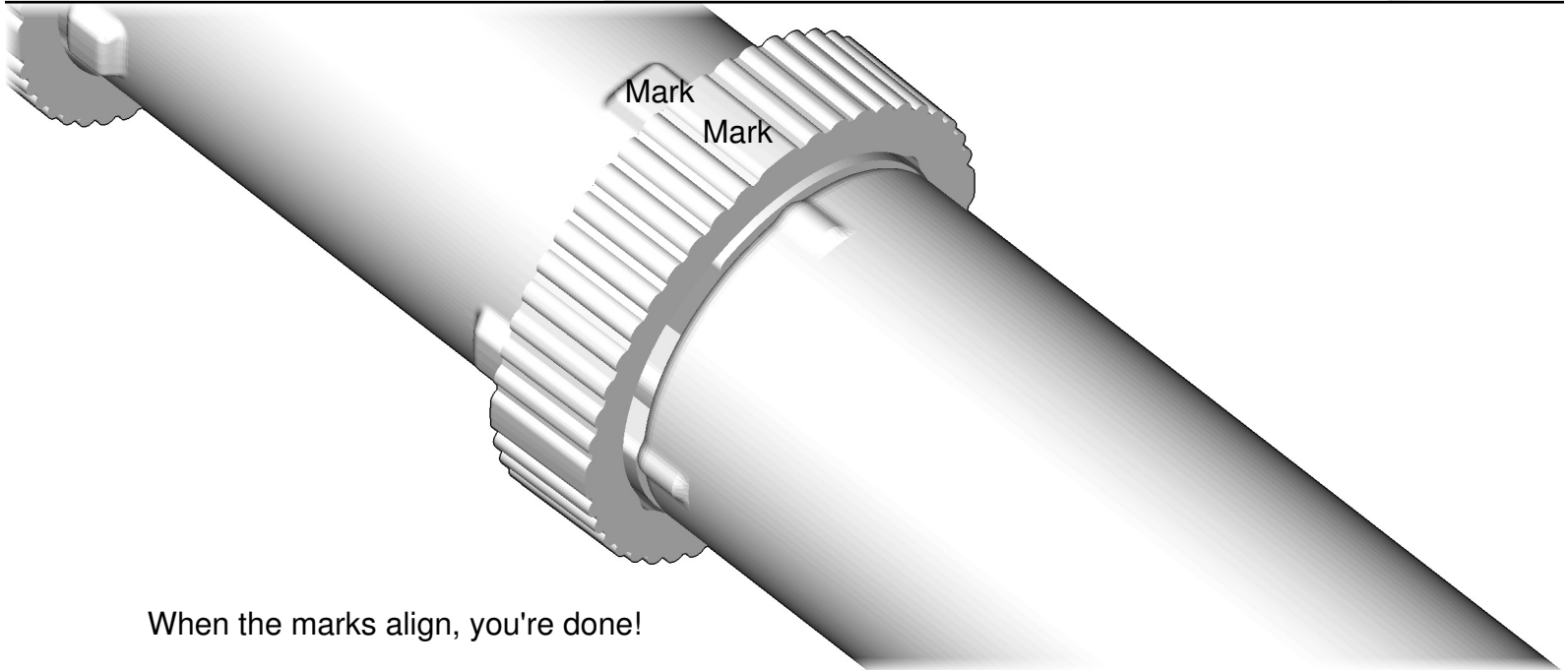
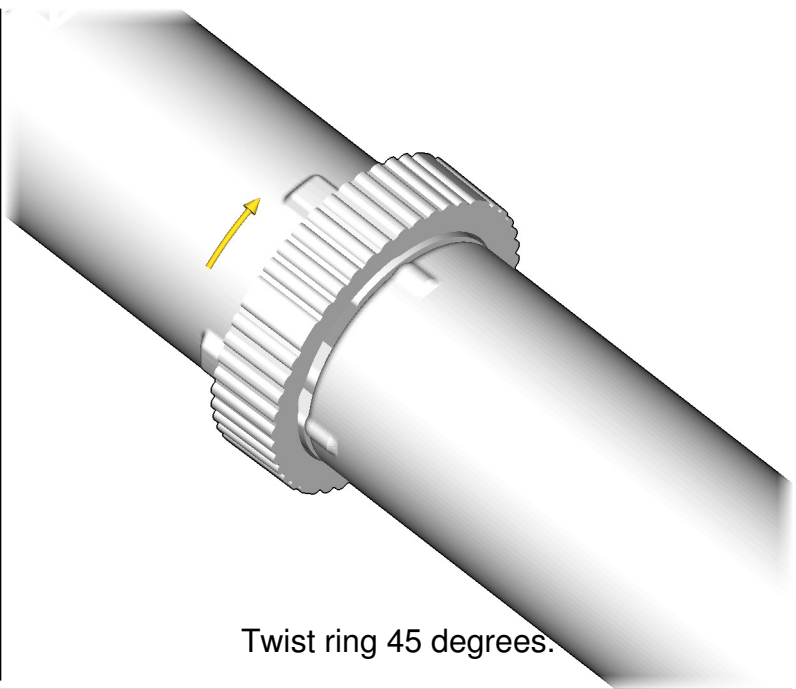
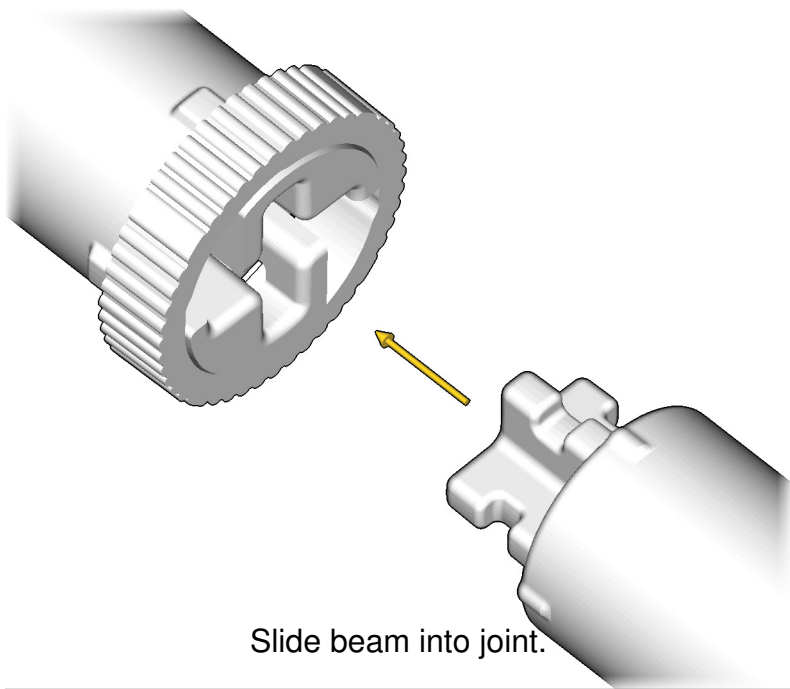

Wrong
Connecting/Disconnecting Two Directions

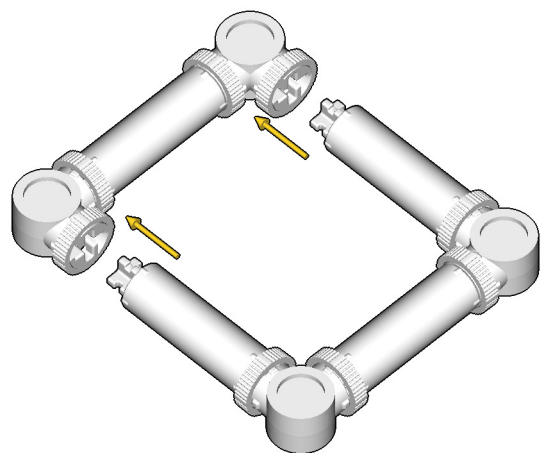

Right
Connecting/Disconnecting One Direction

1



New pieces are drawn blue. Old pieces are drawn white.
See back for piece names.

2

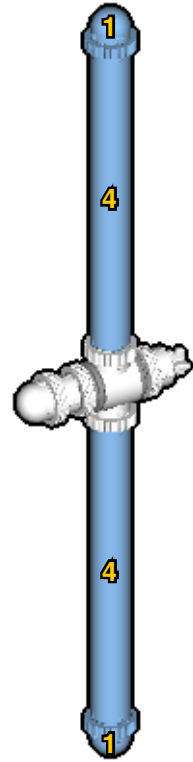

Connect new pieces together before connecting to old pieces.

3

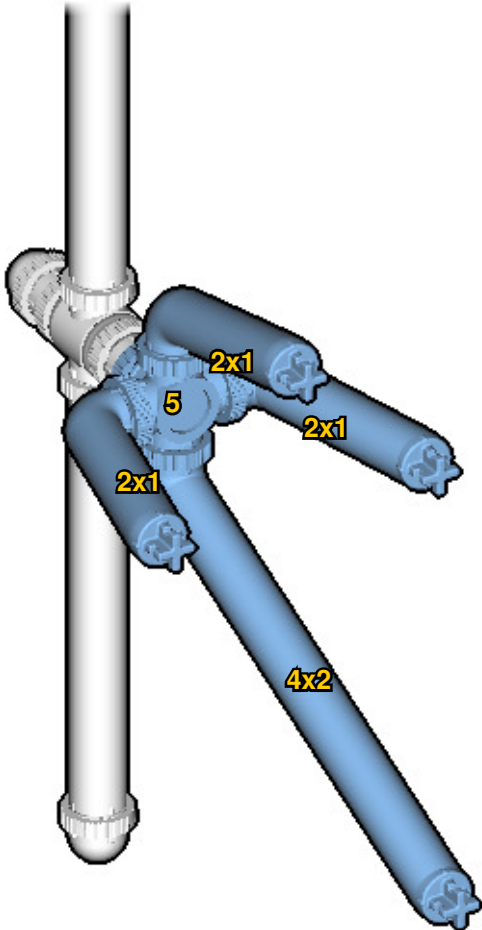

4

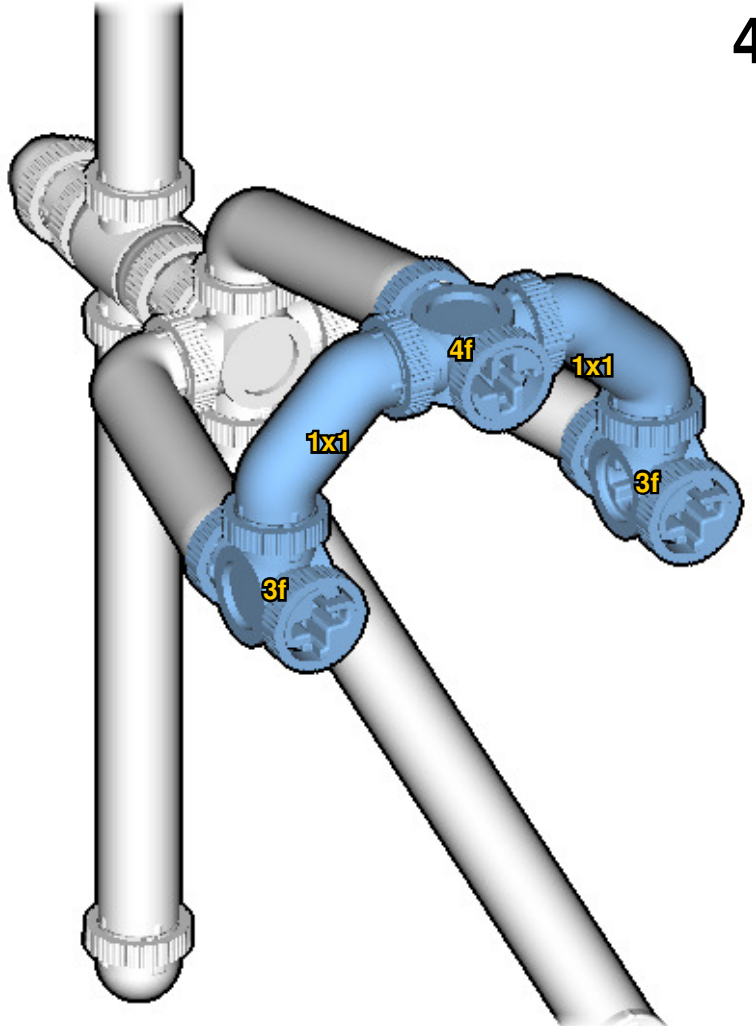

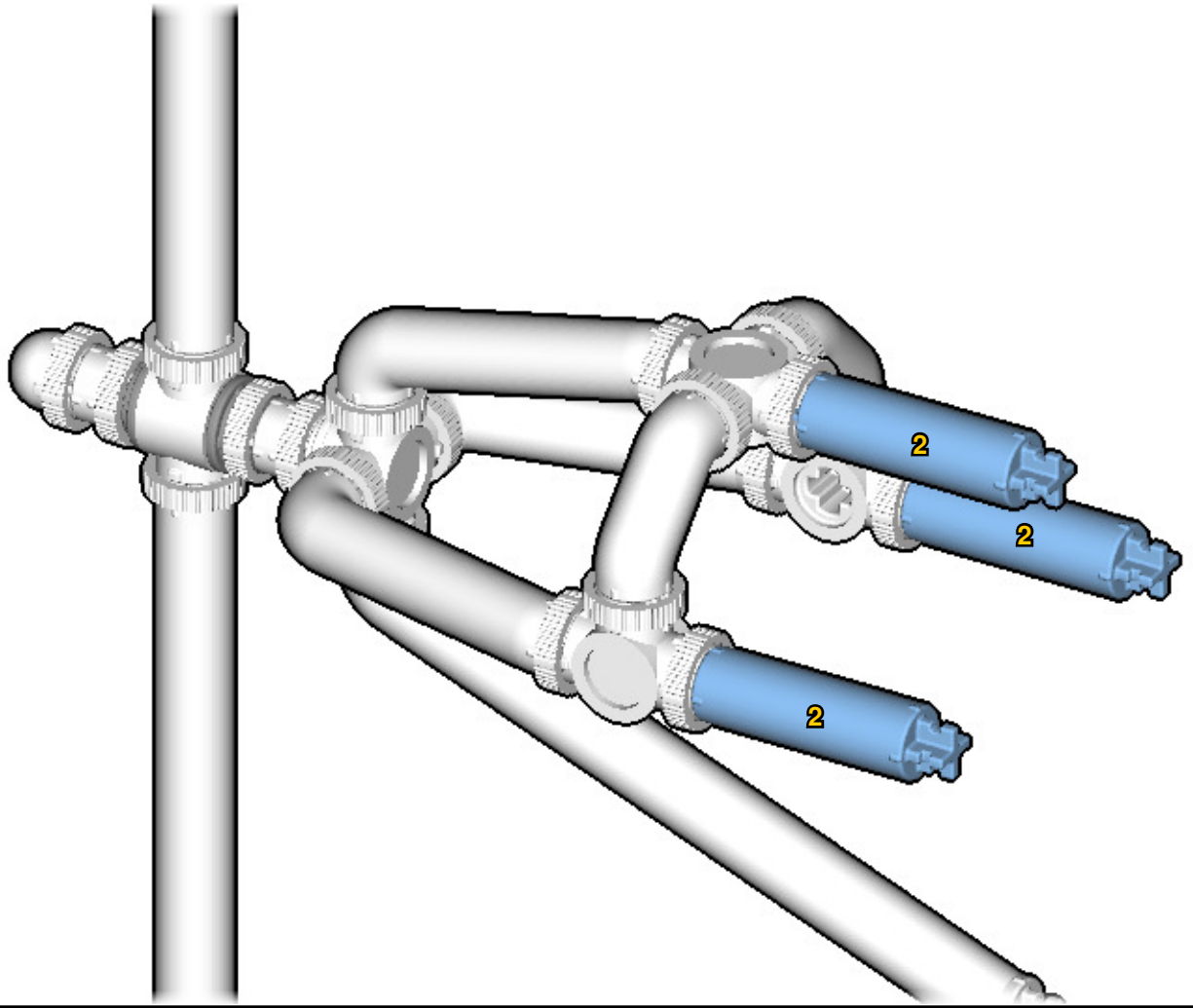

Submodel begins → **6**

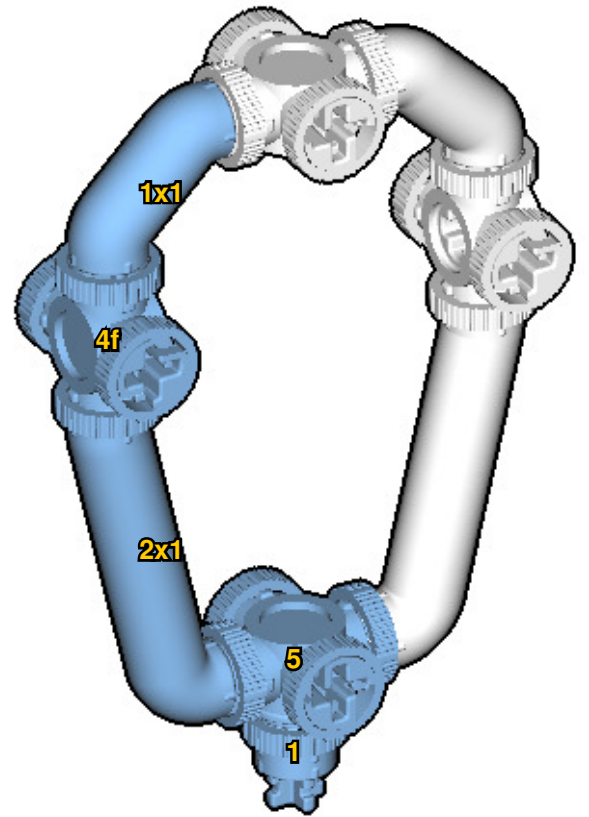
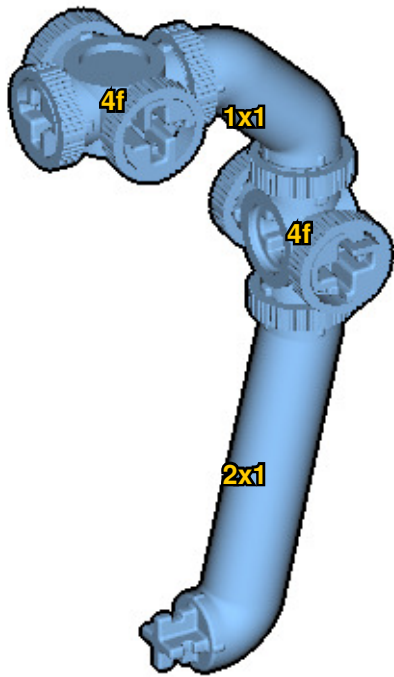

Submodel ends → **8**

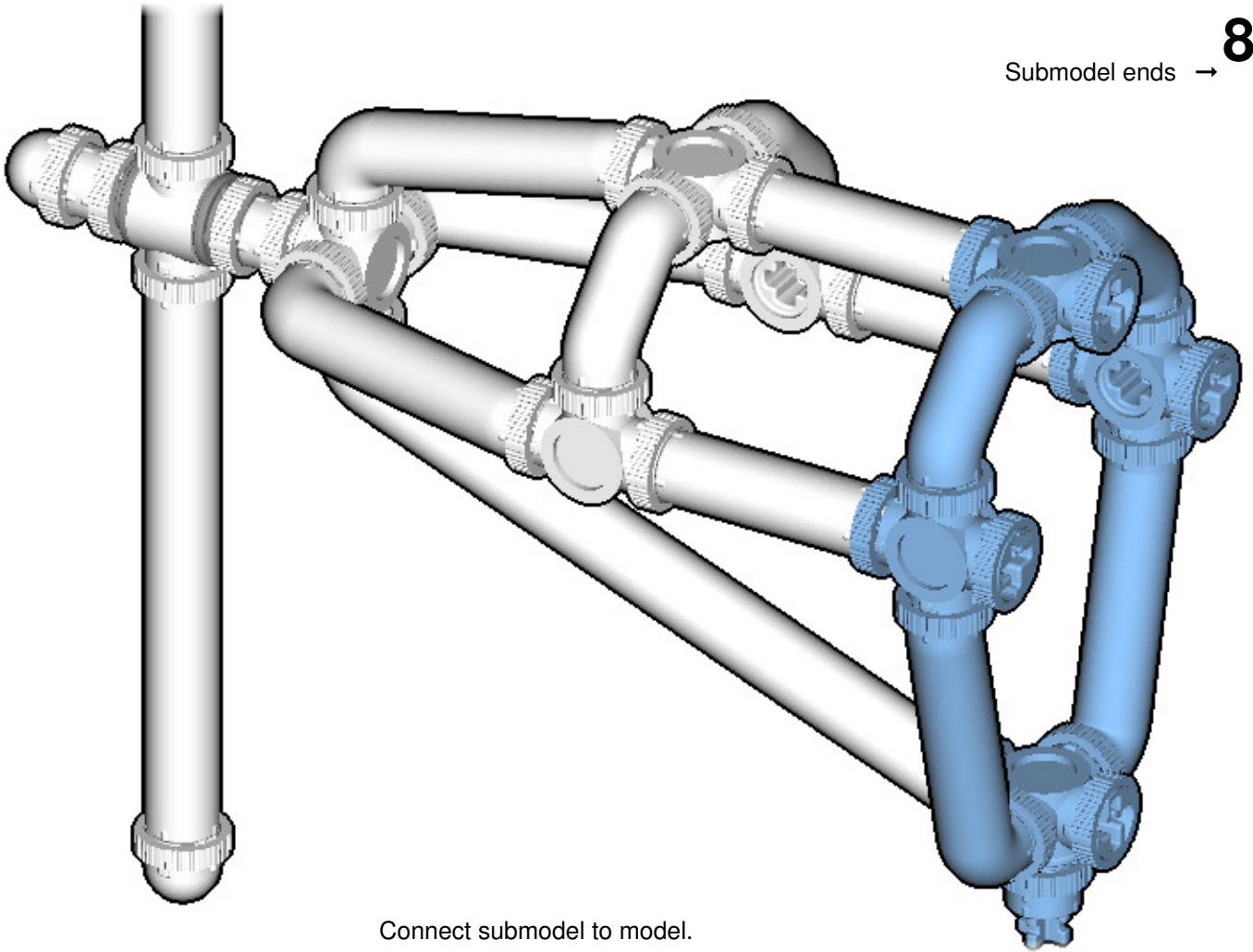

Connect submodel to model.

9

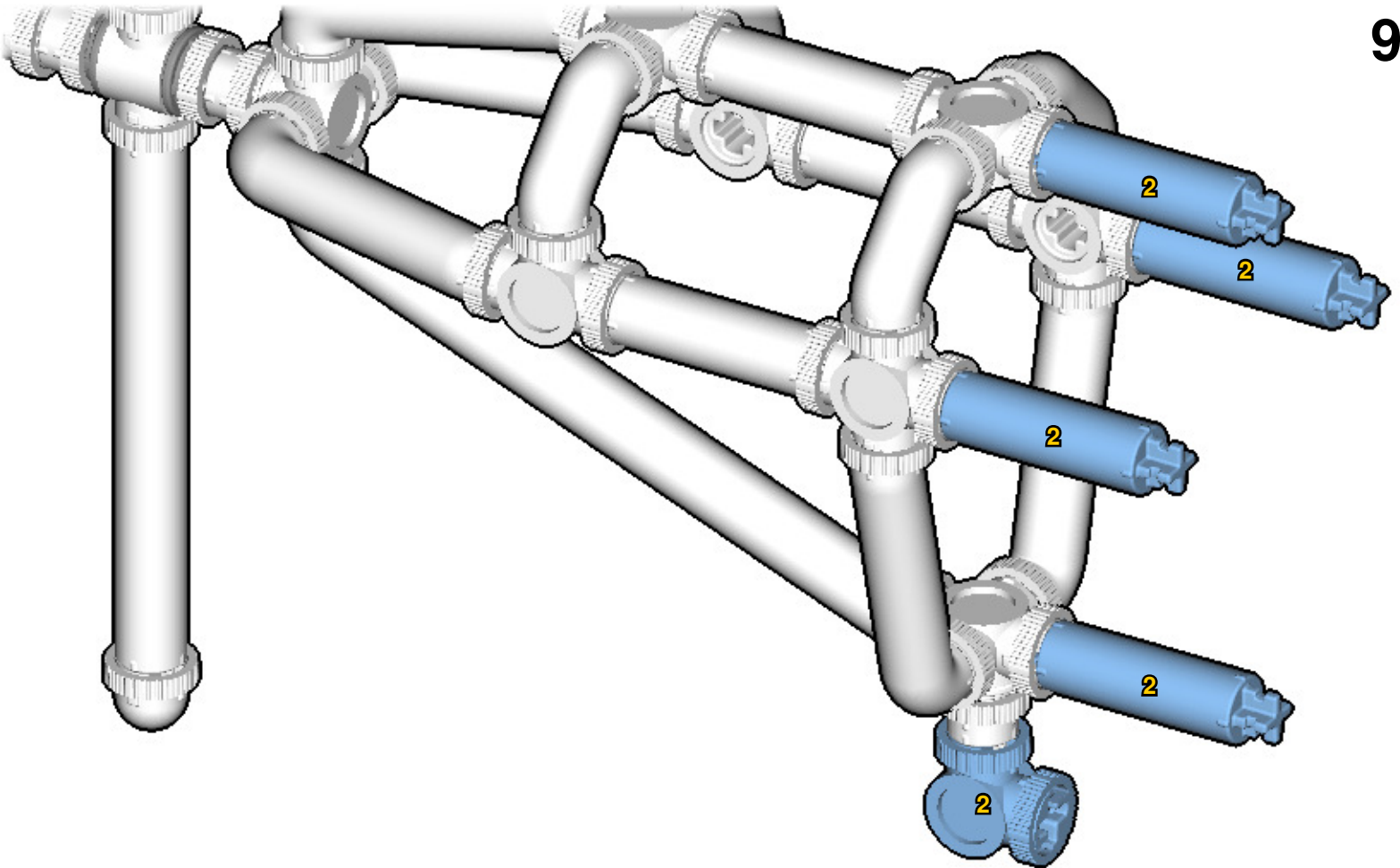

10

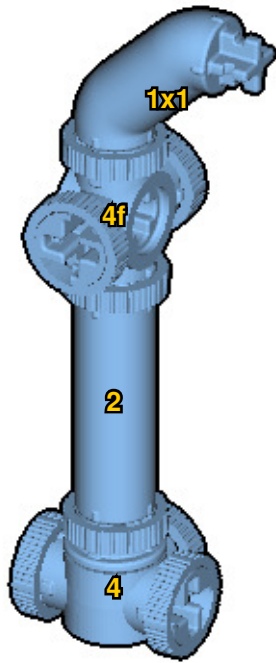

11

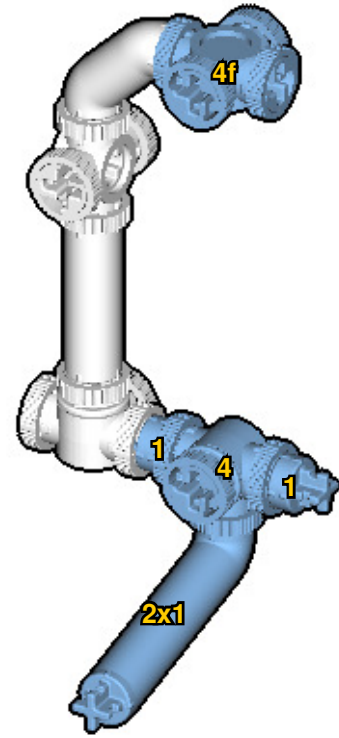

12

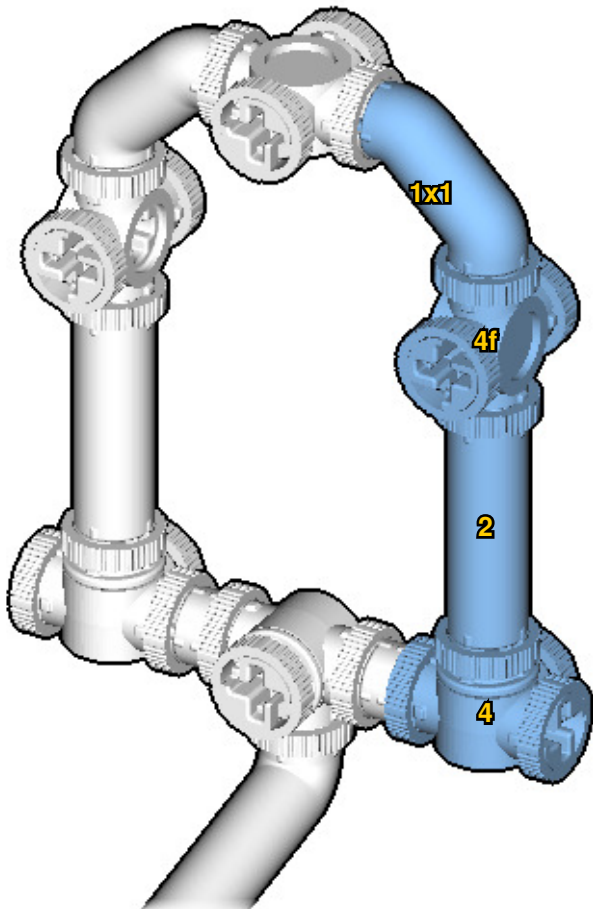

13

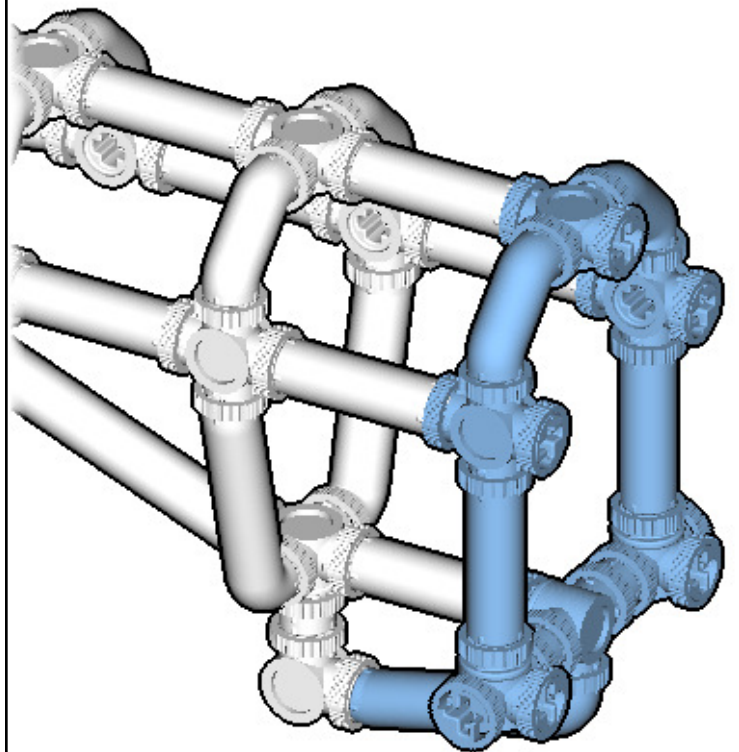

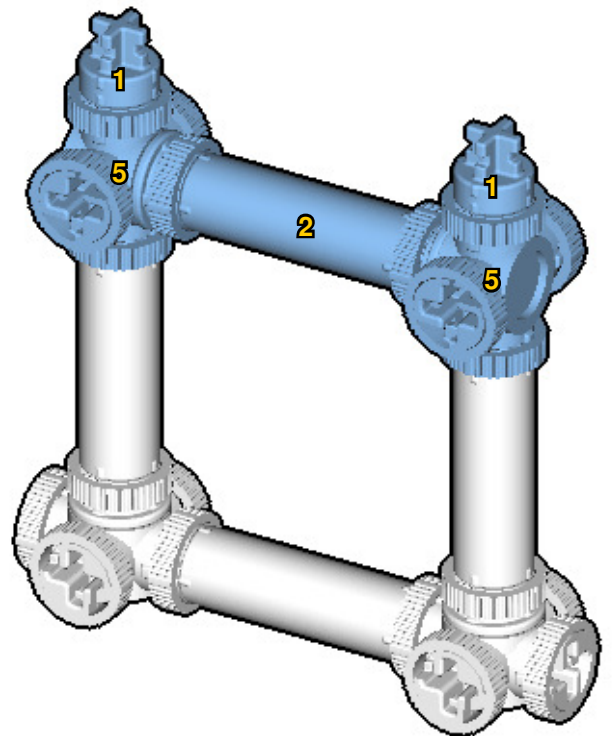
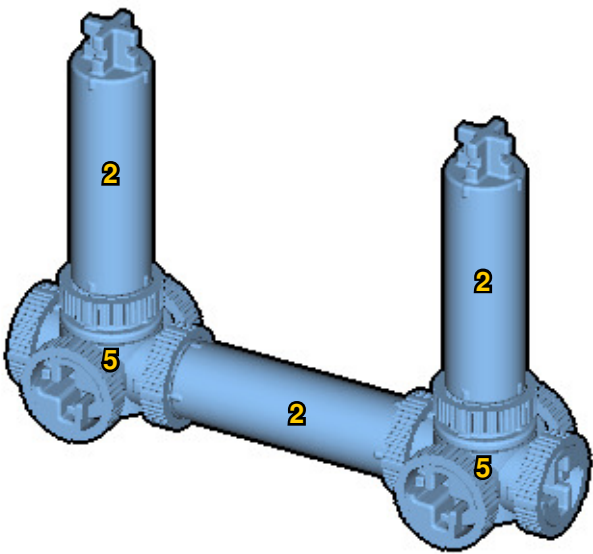
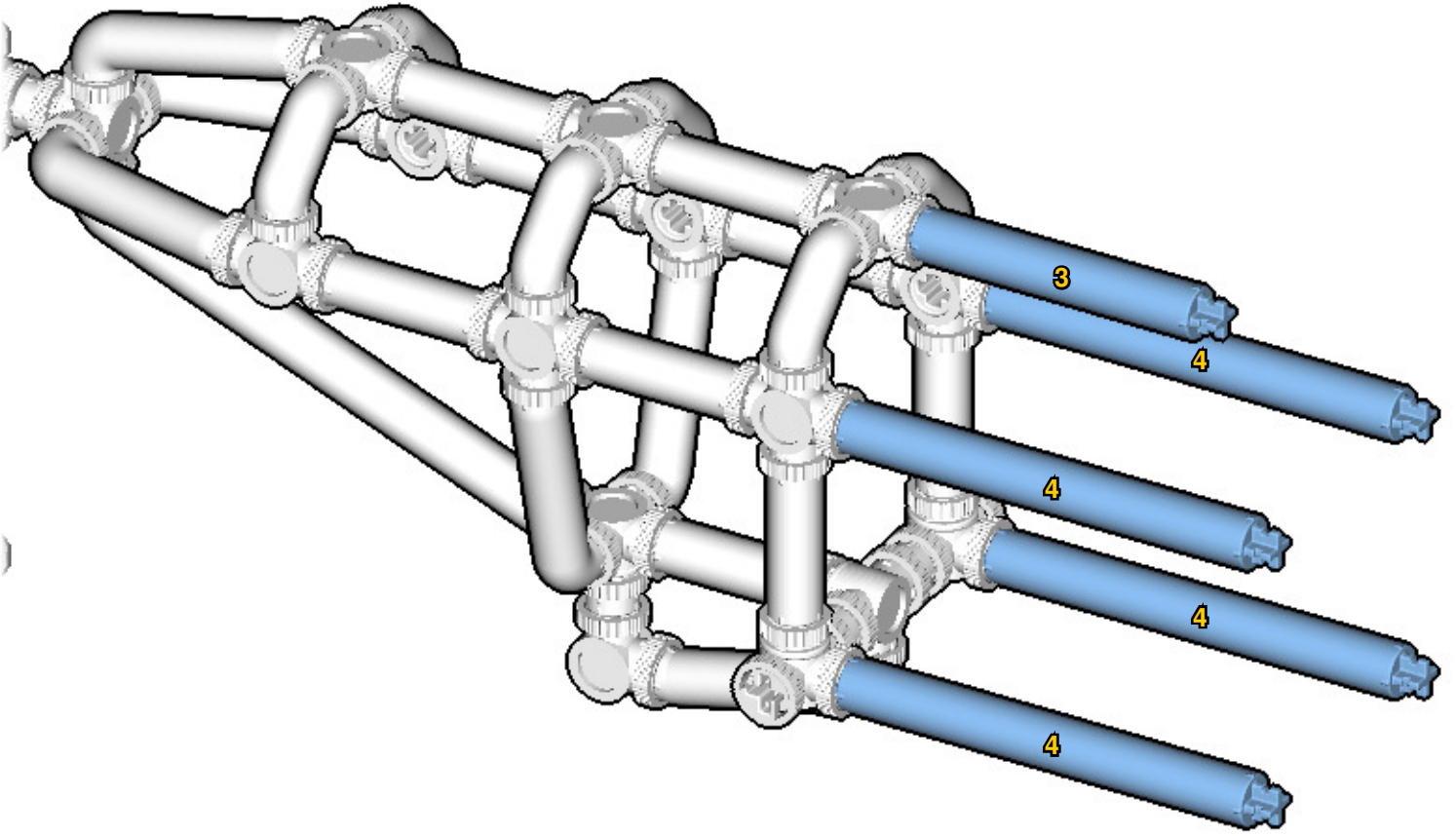

17

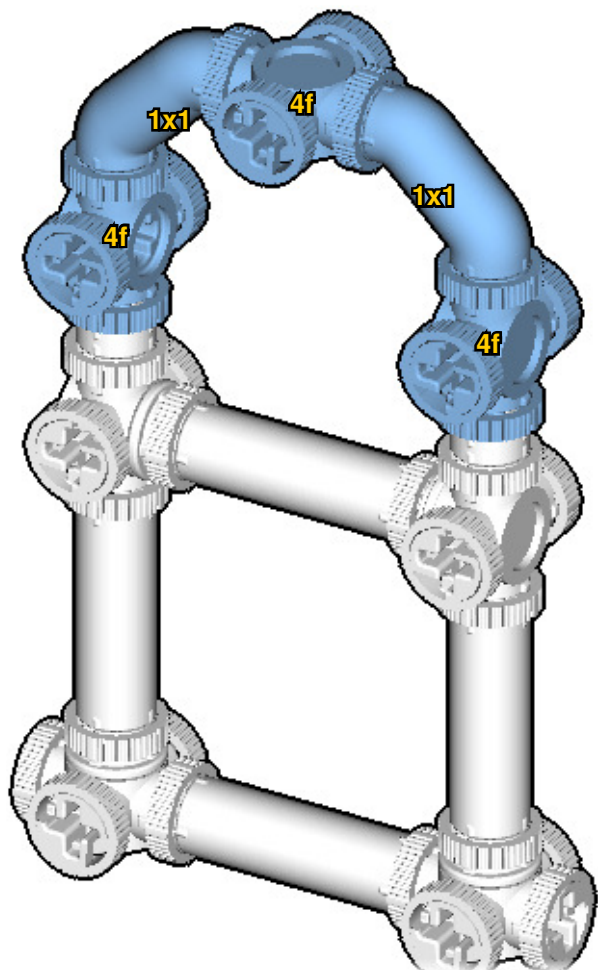

18

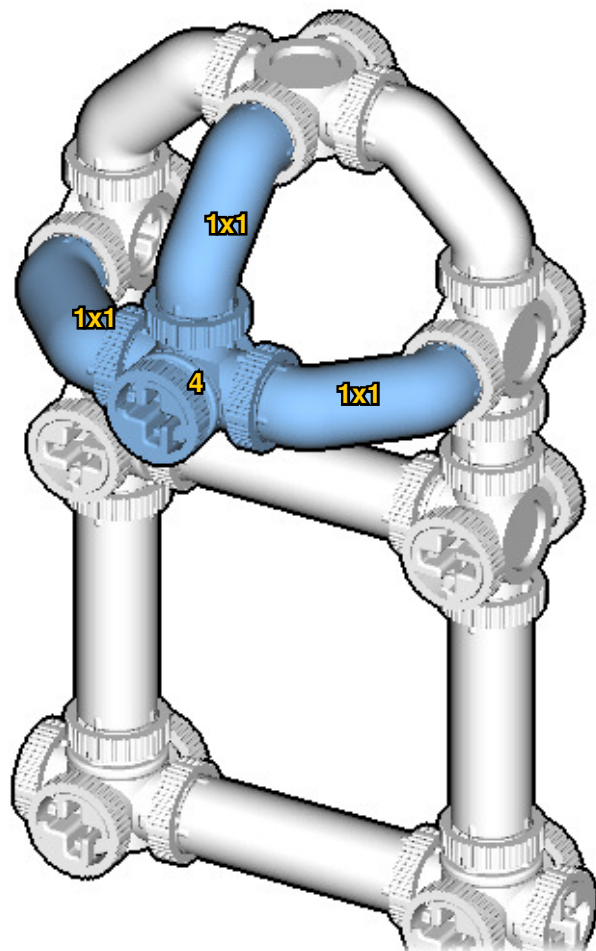

19

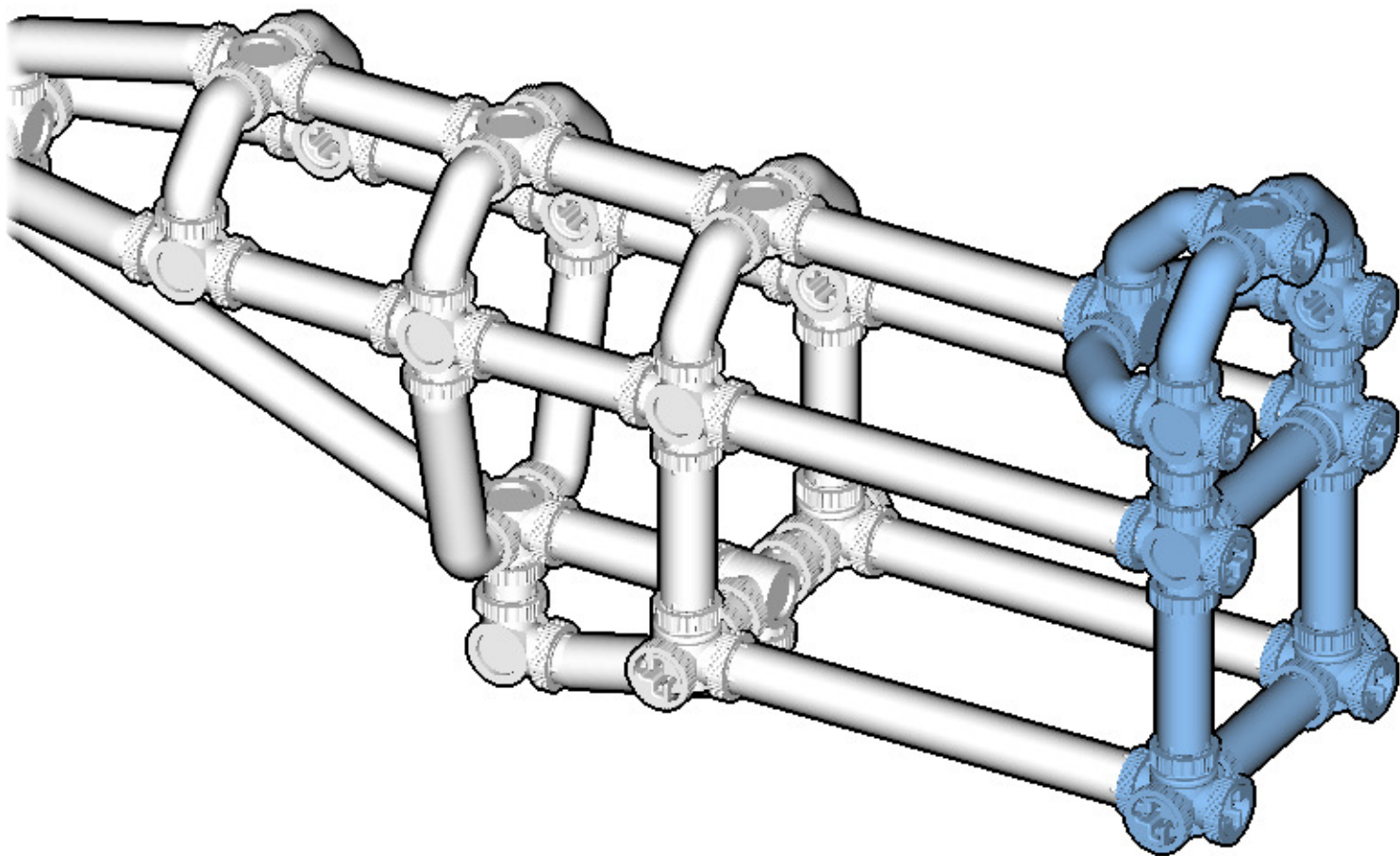

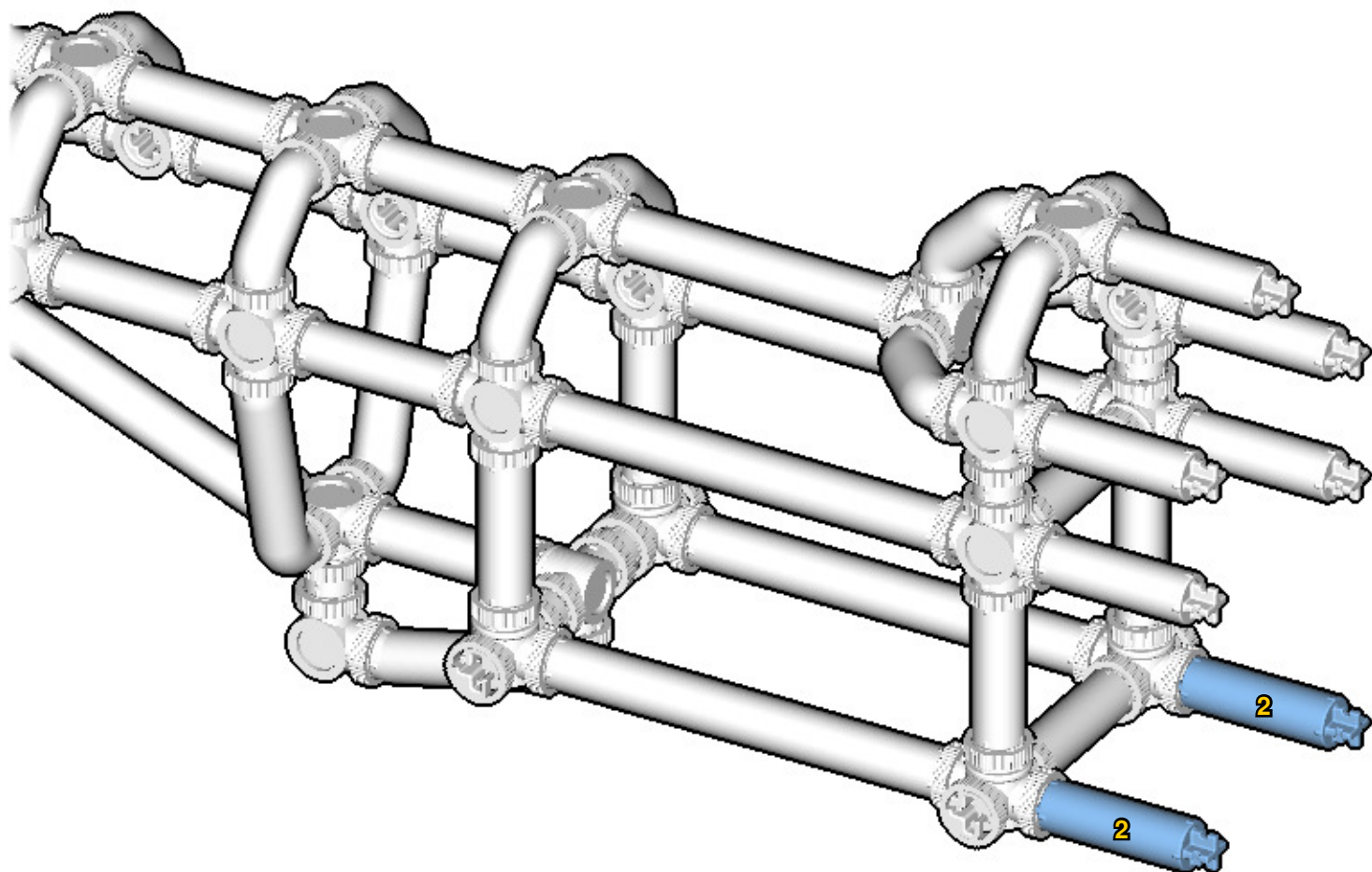
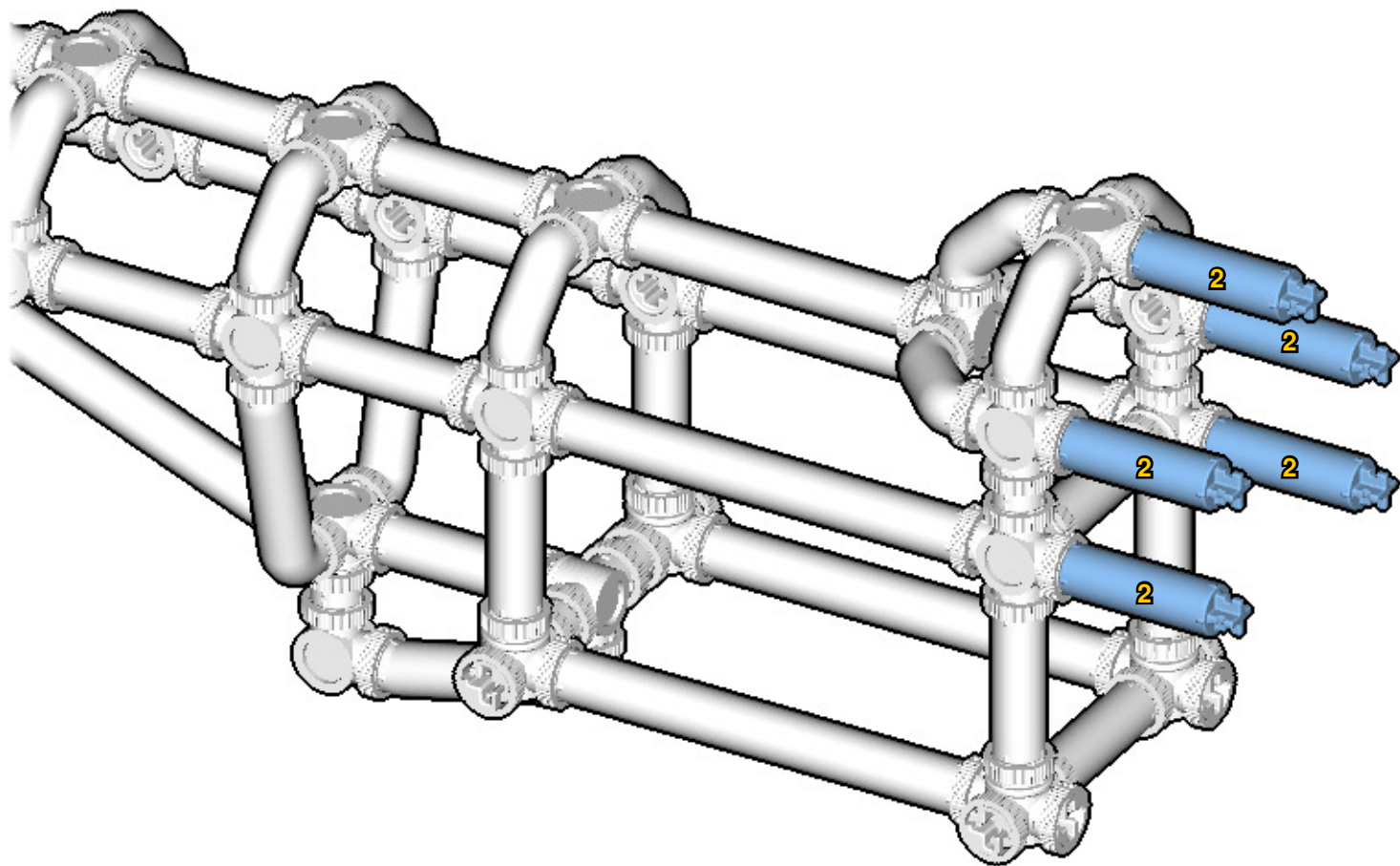

22

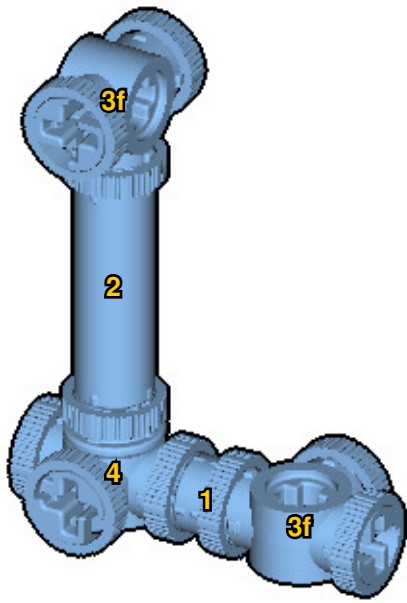

23

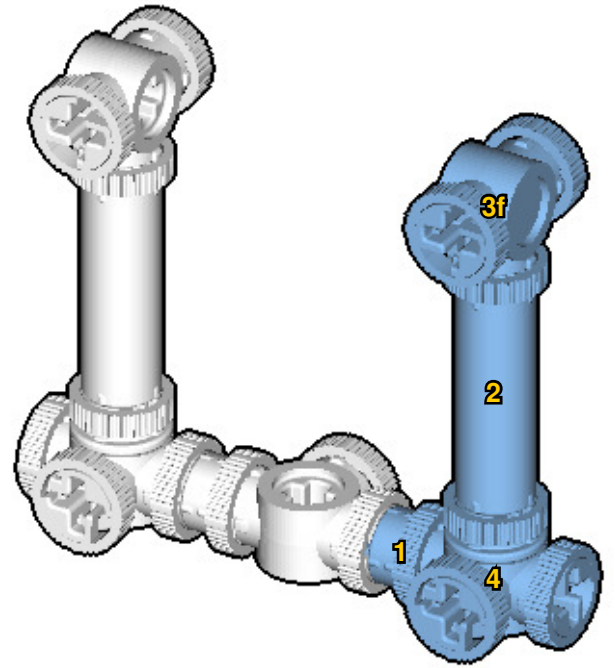

24

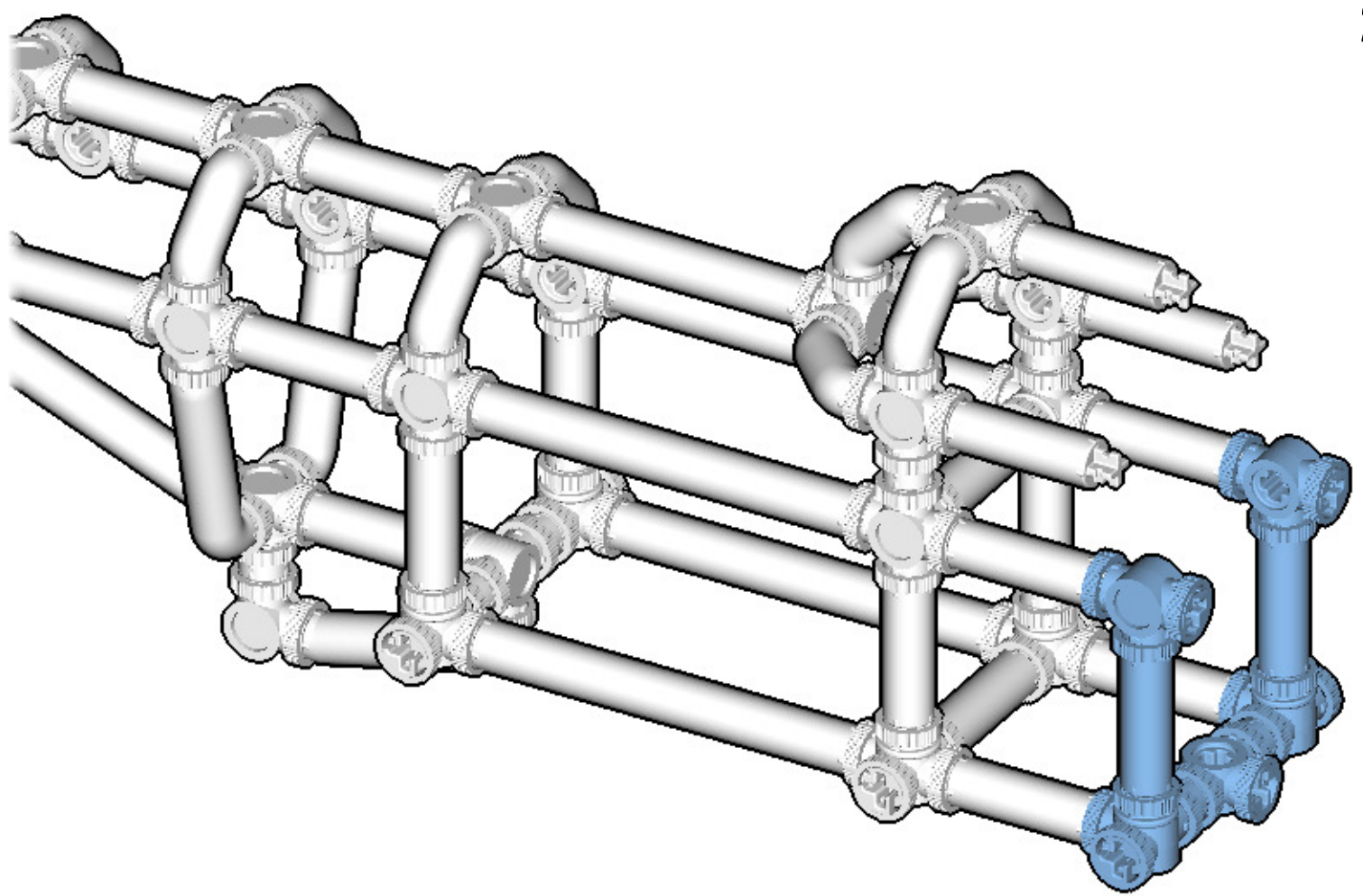

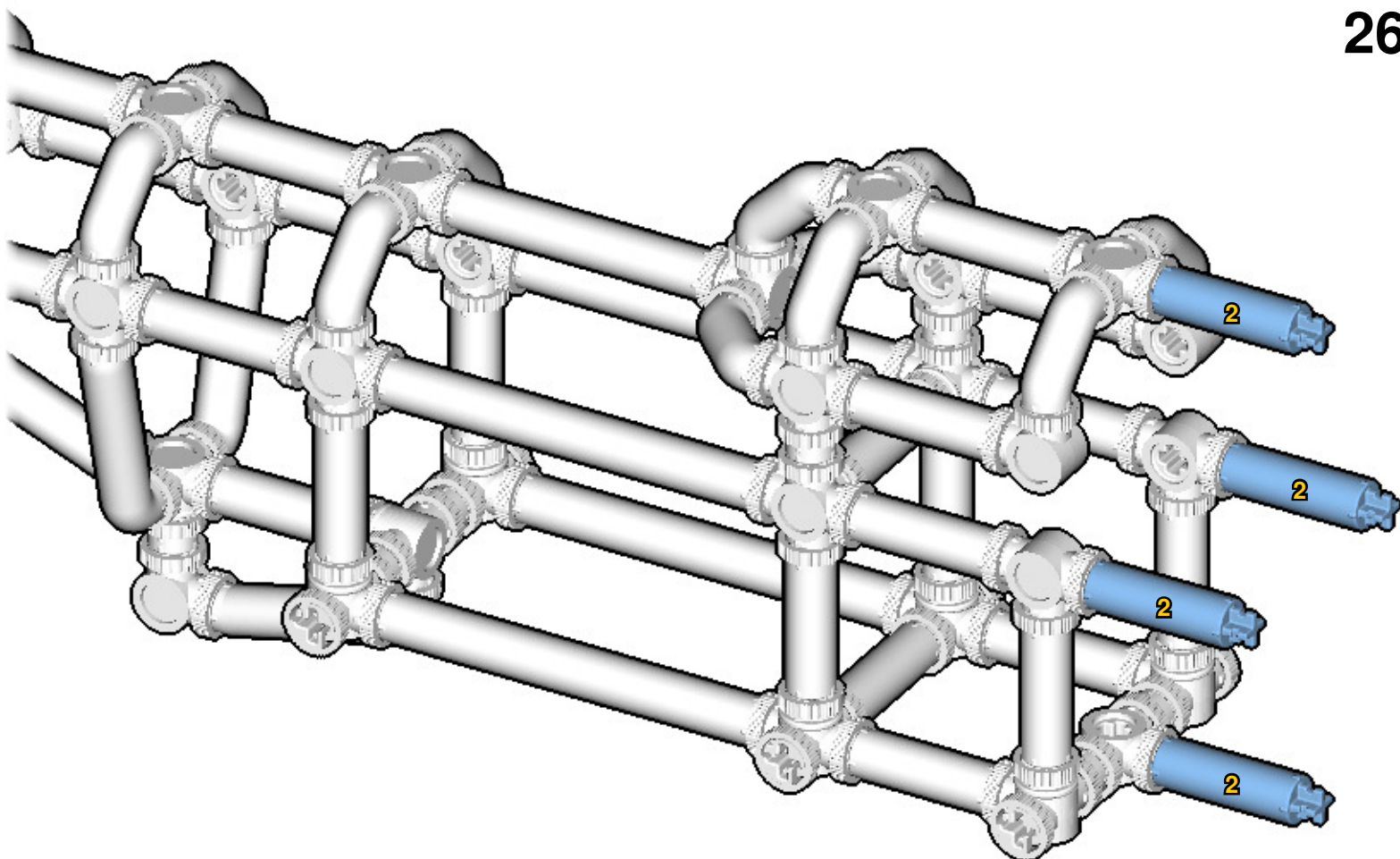
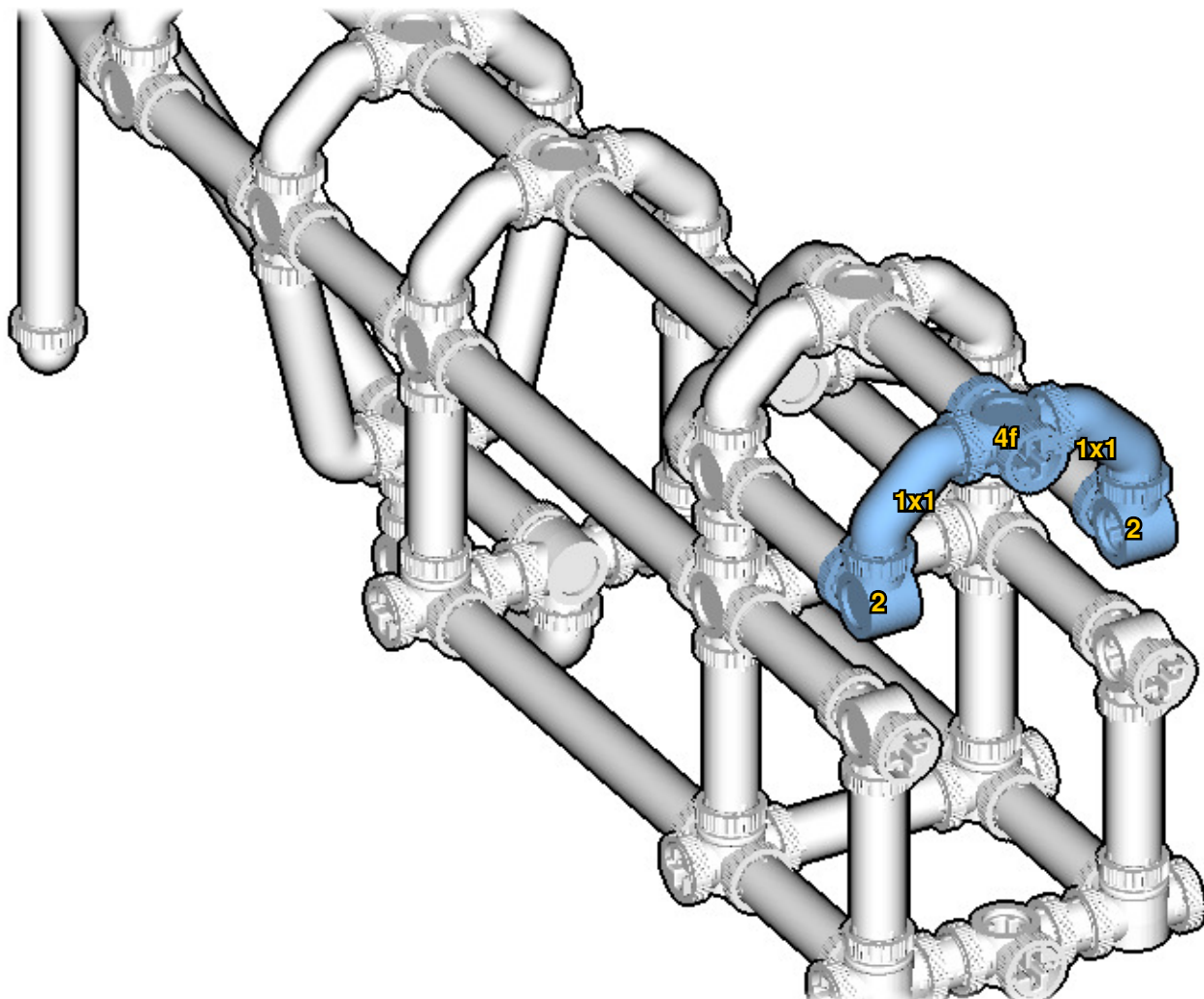

27

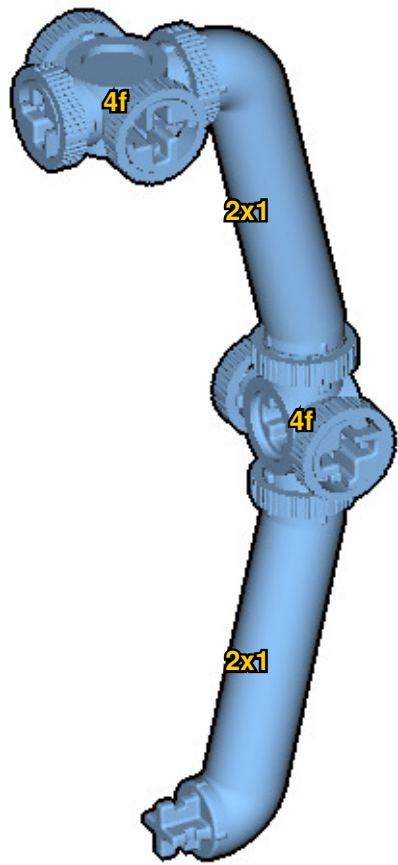

28

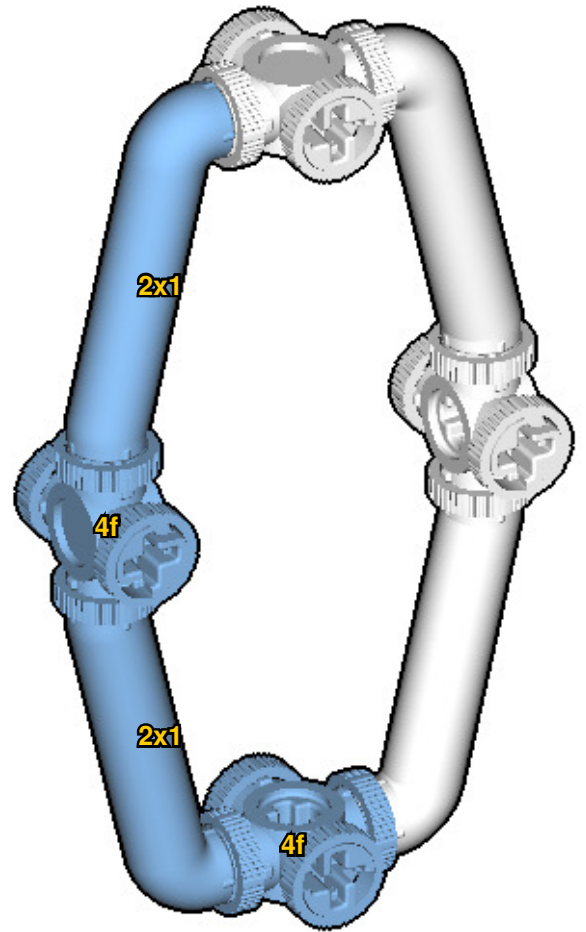

29

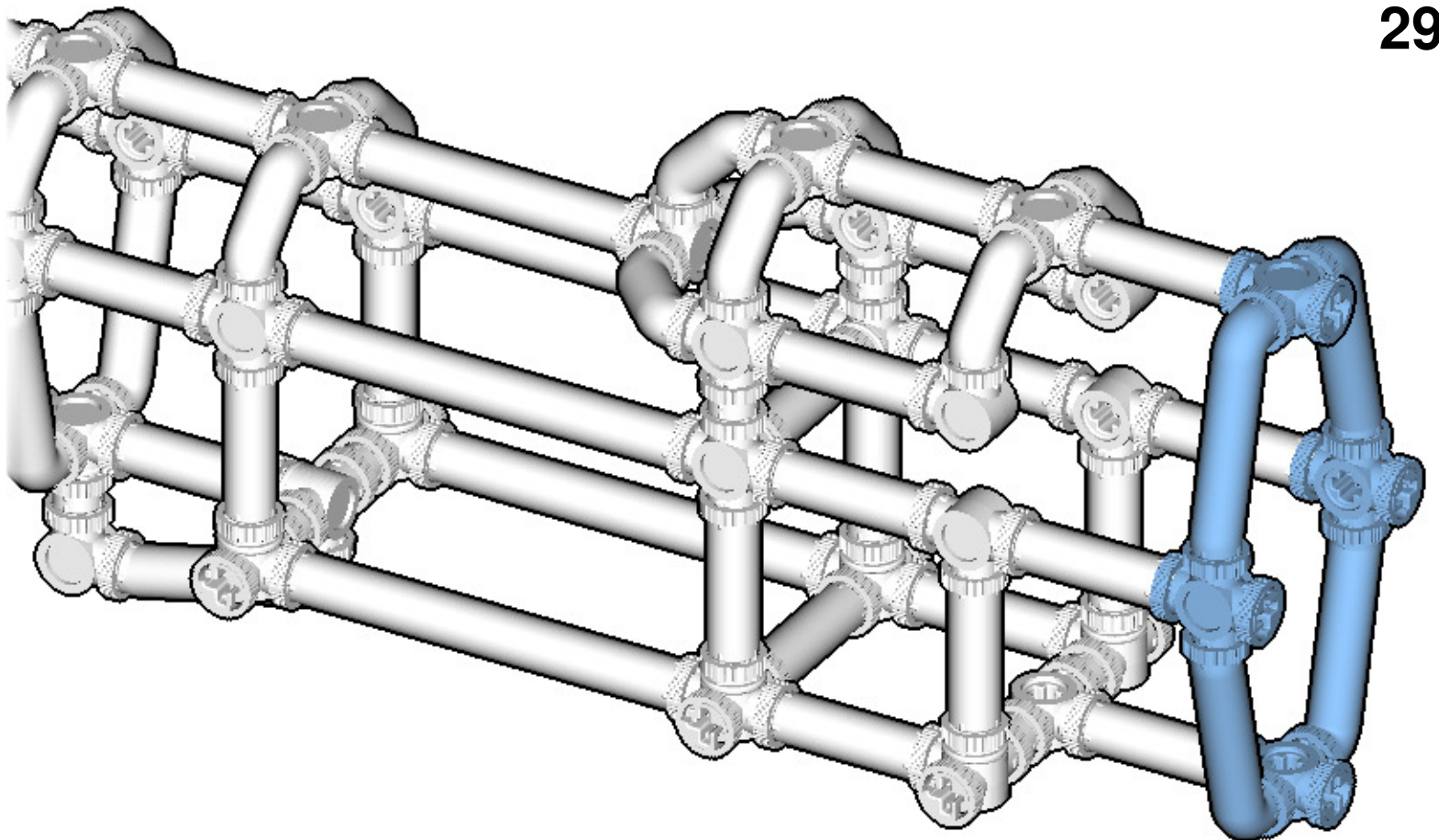

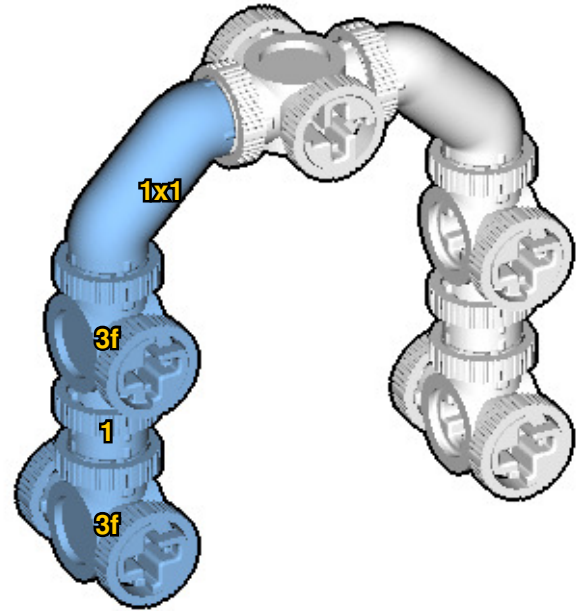
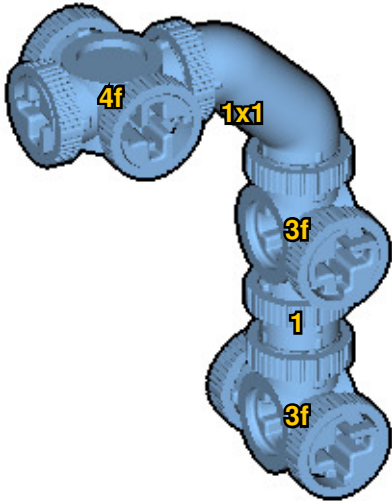
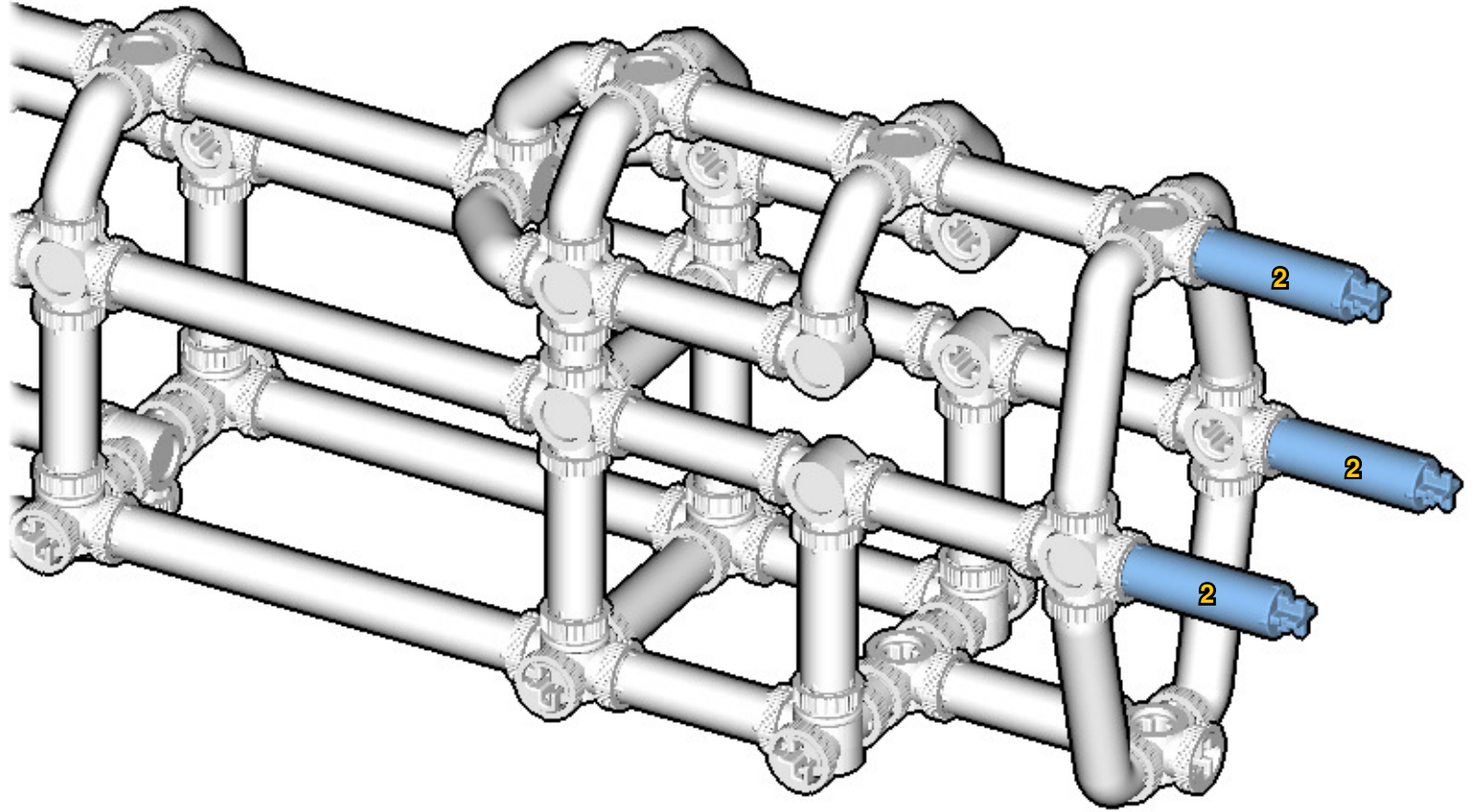

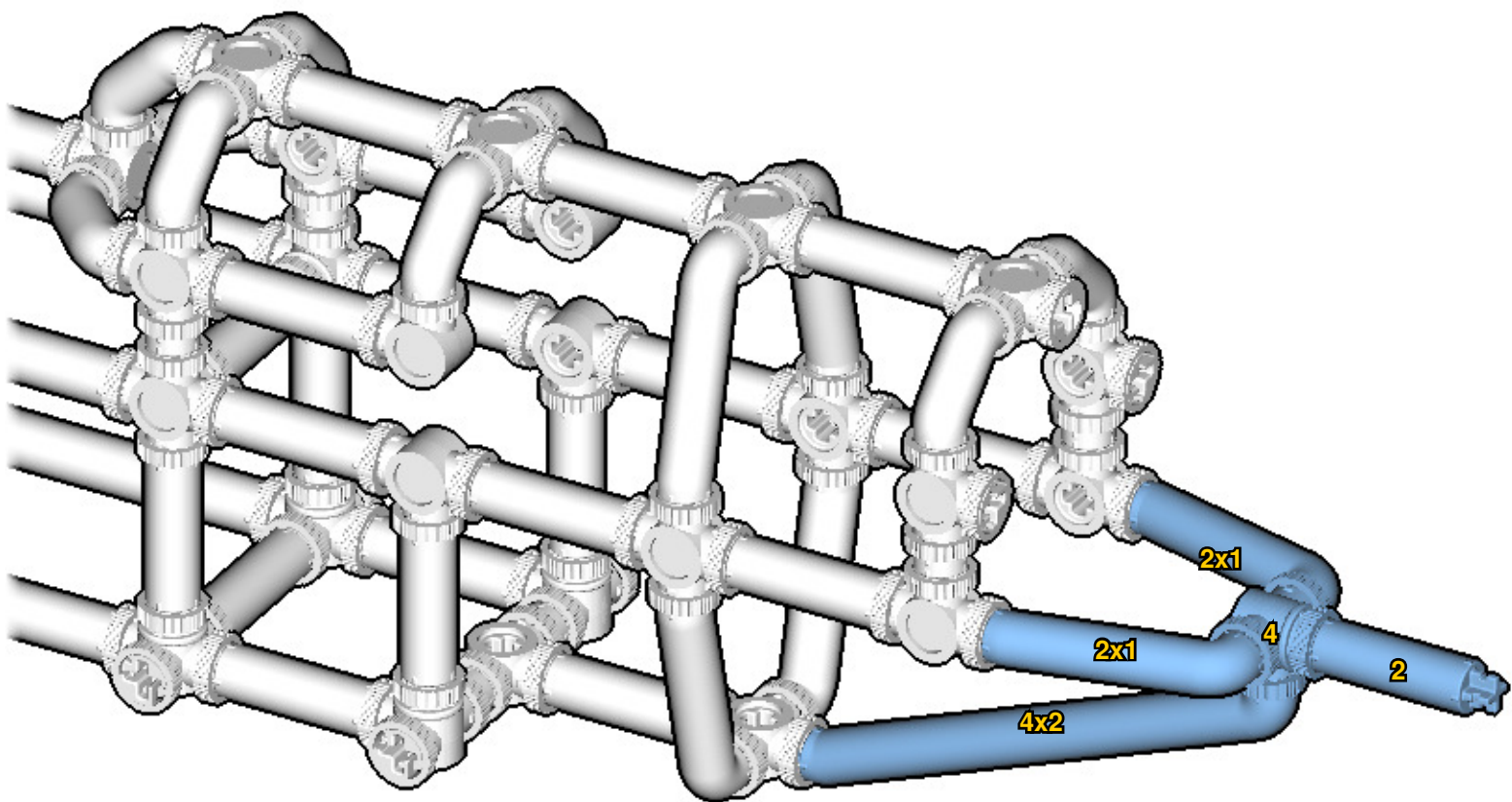
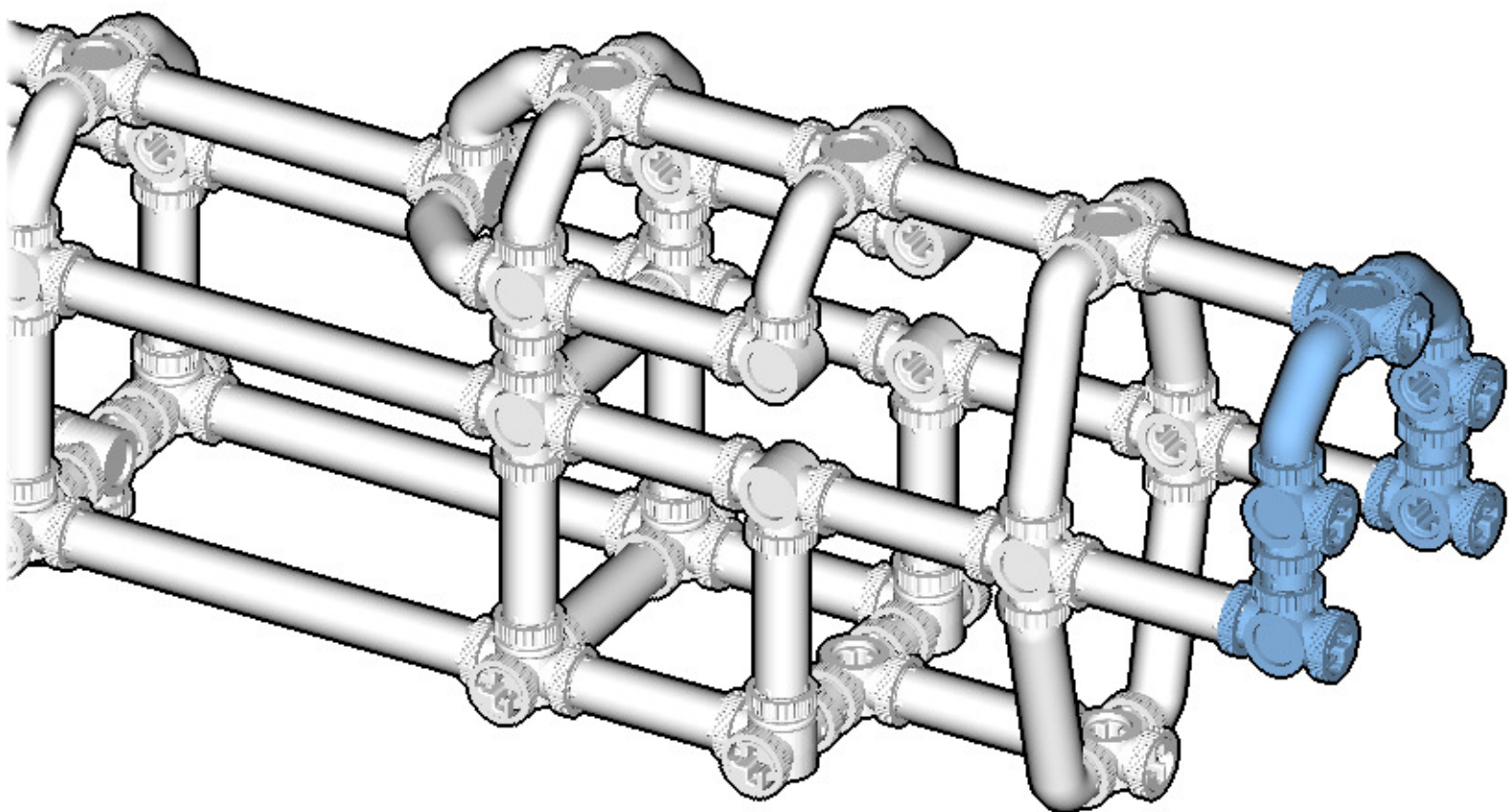

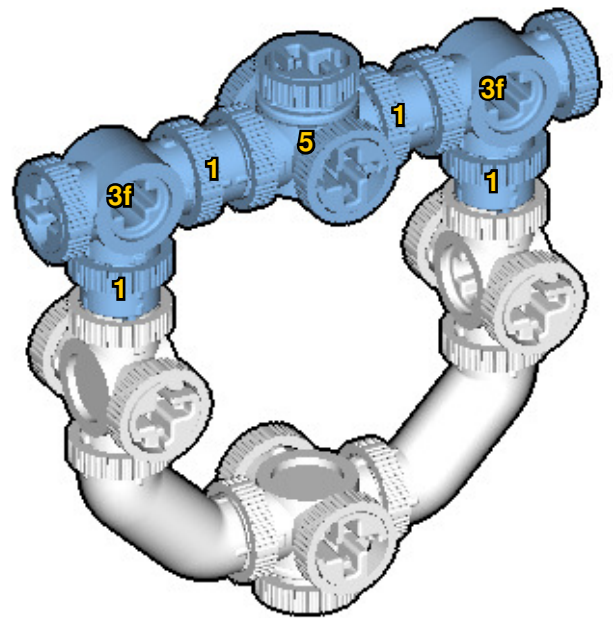
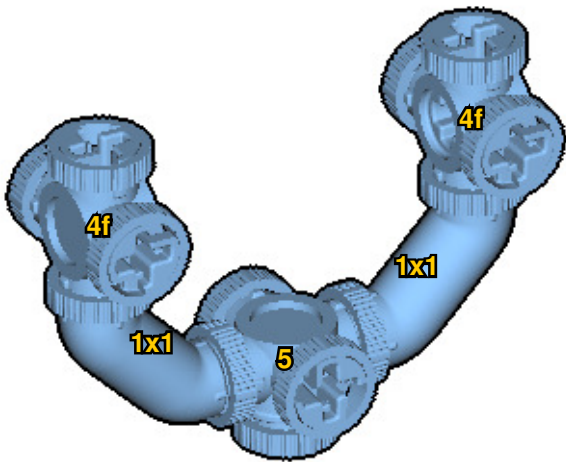
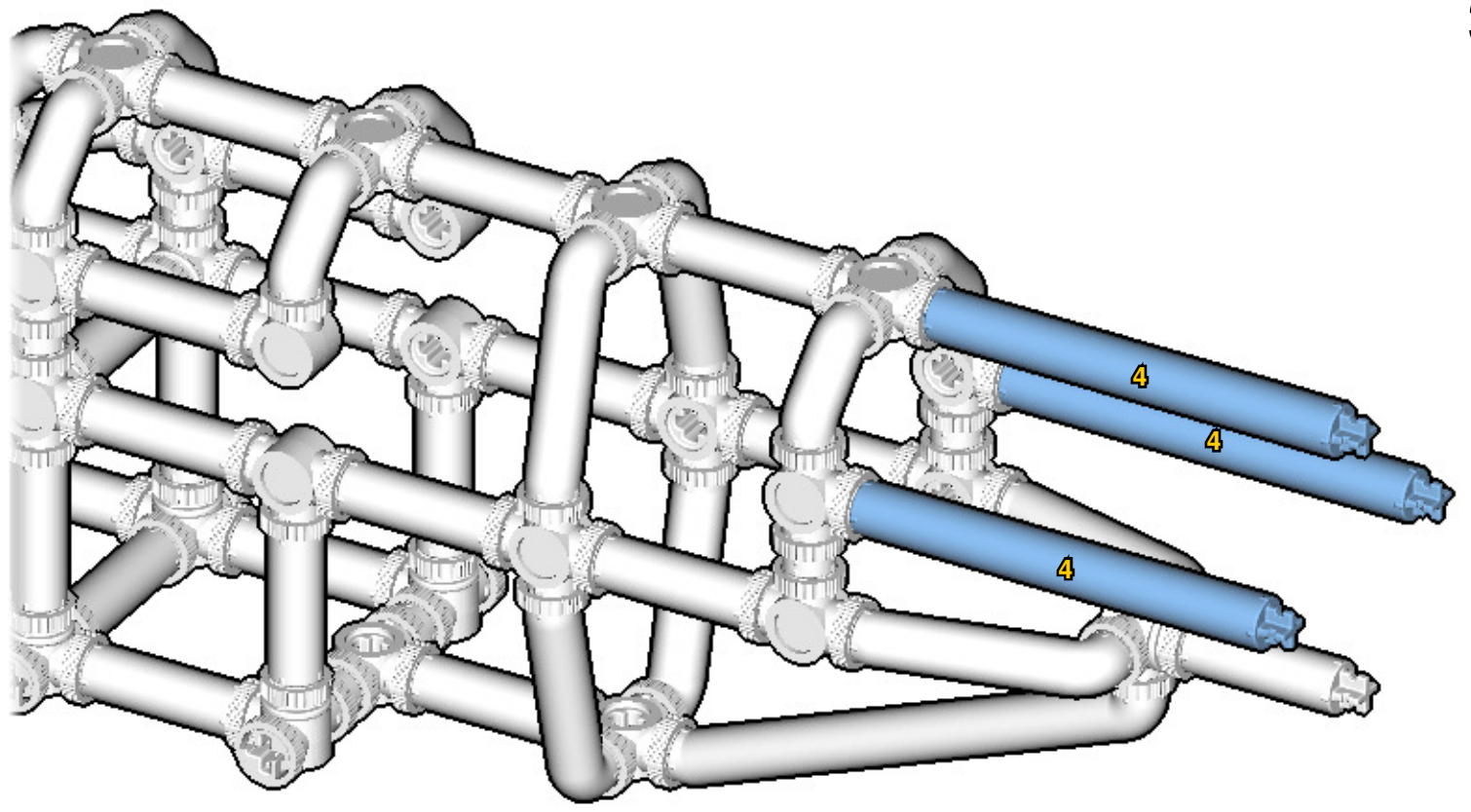

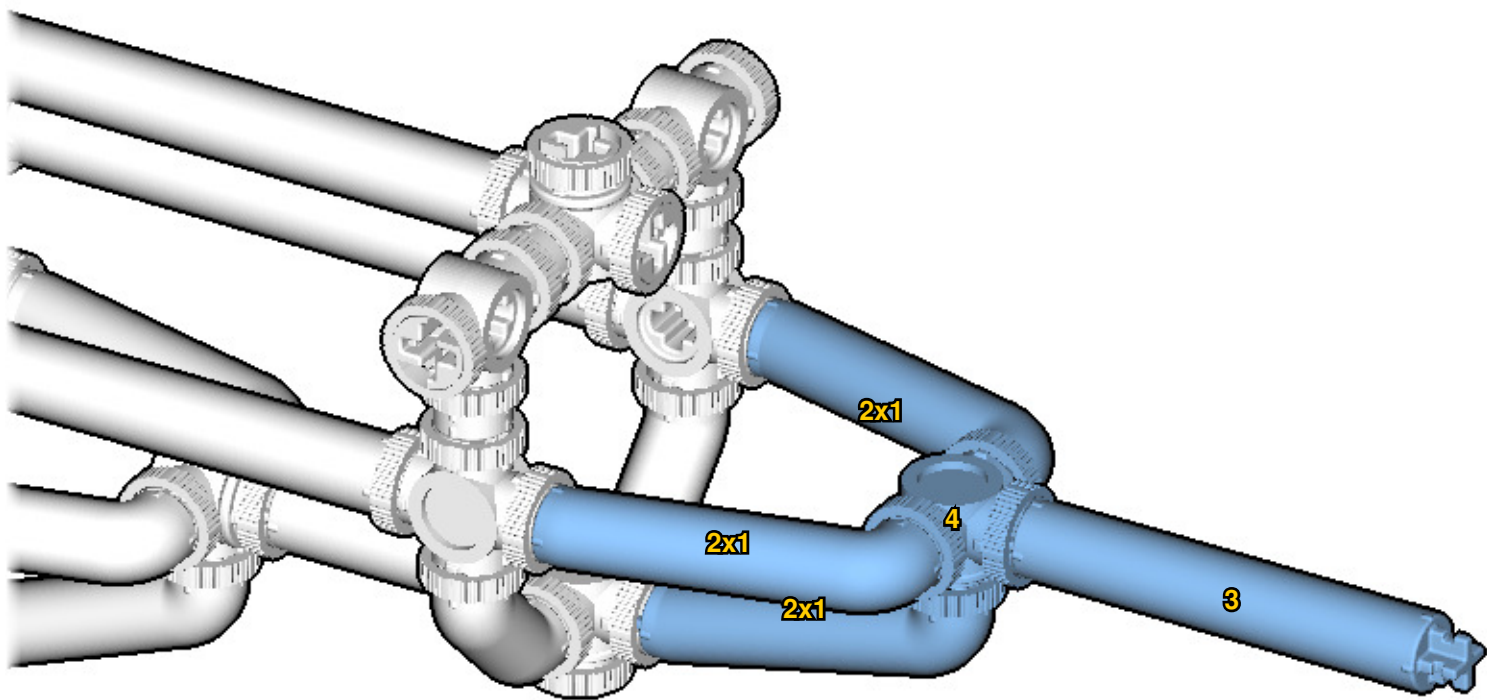
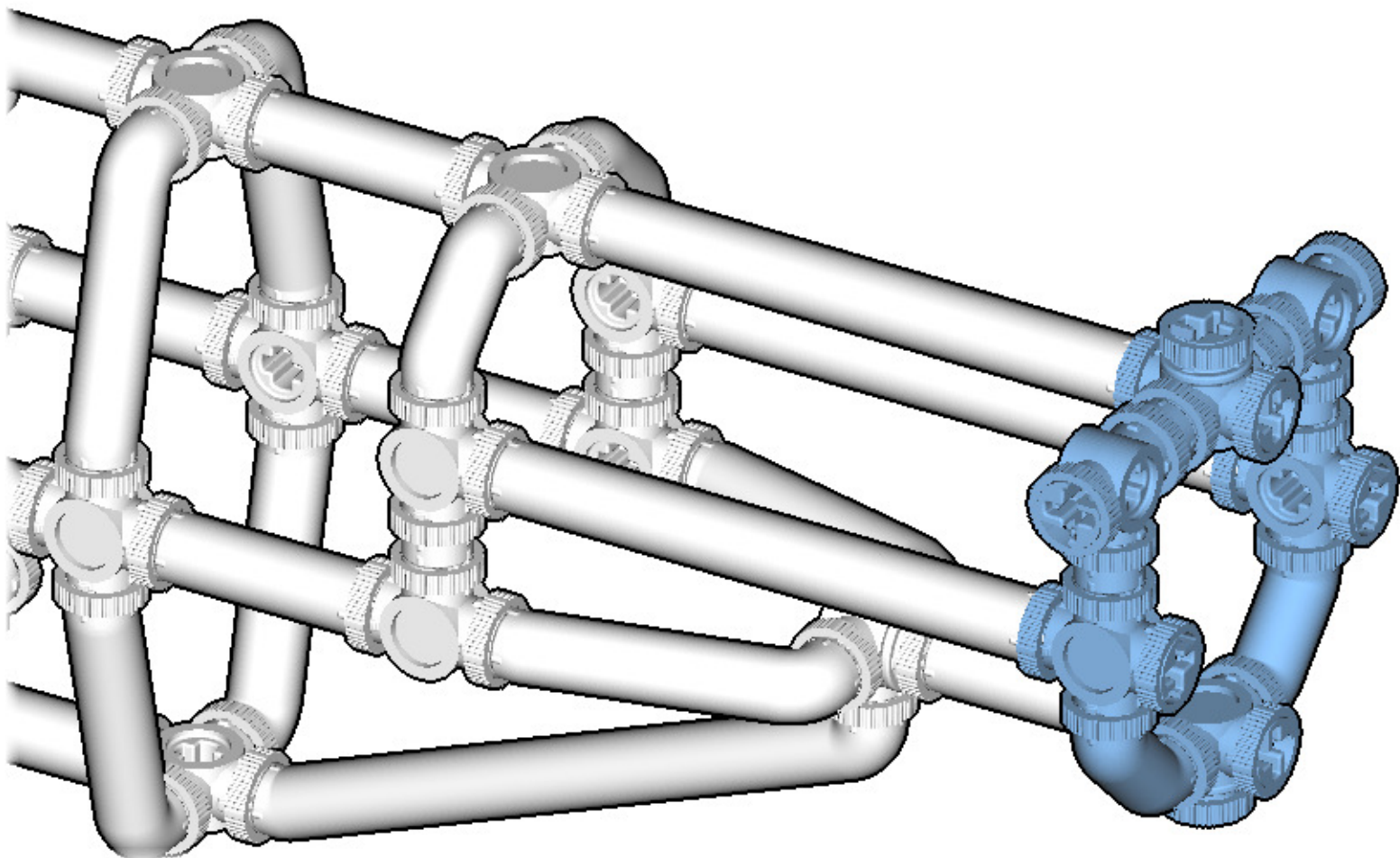

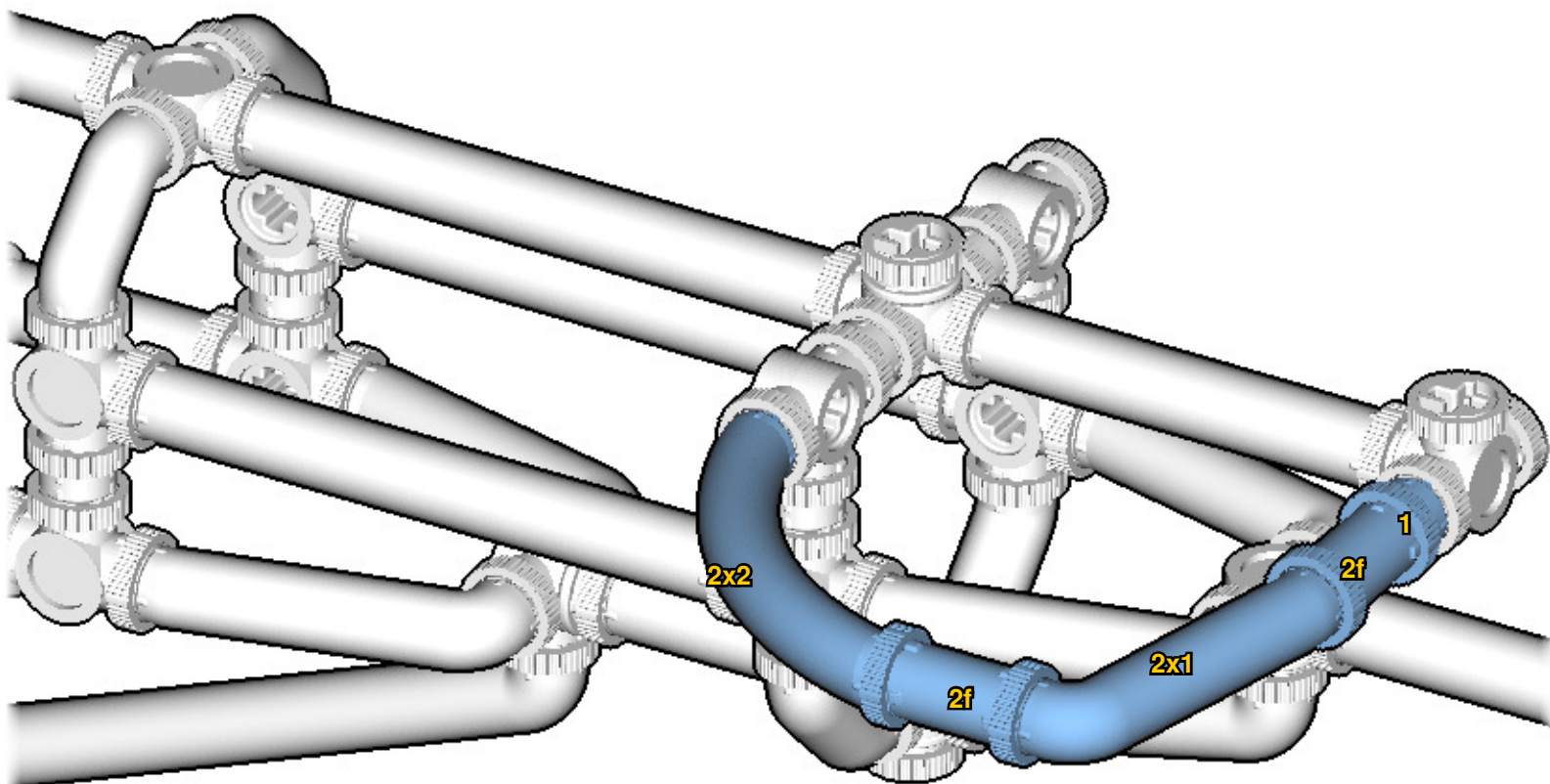
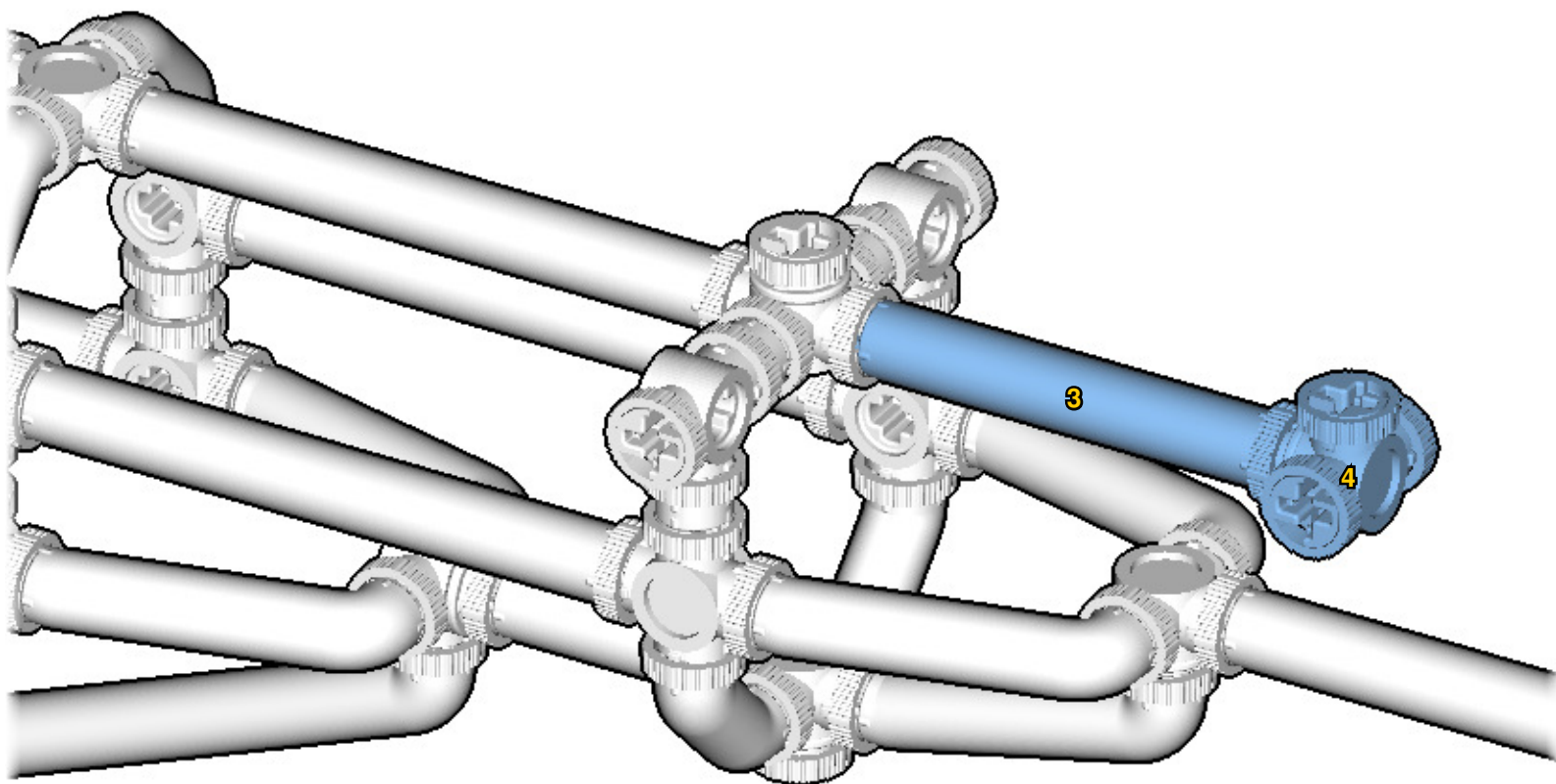

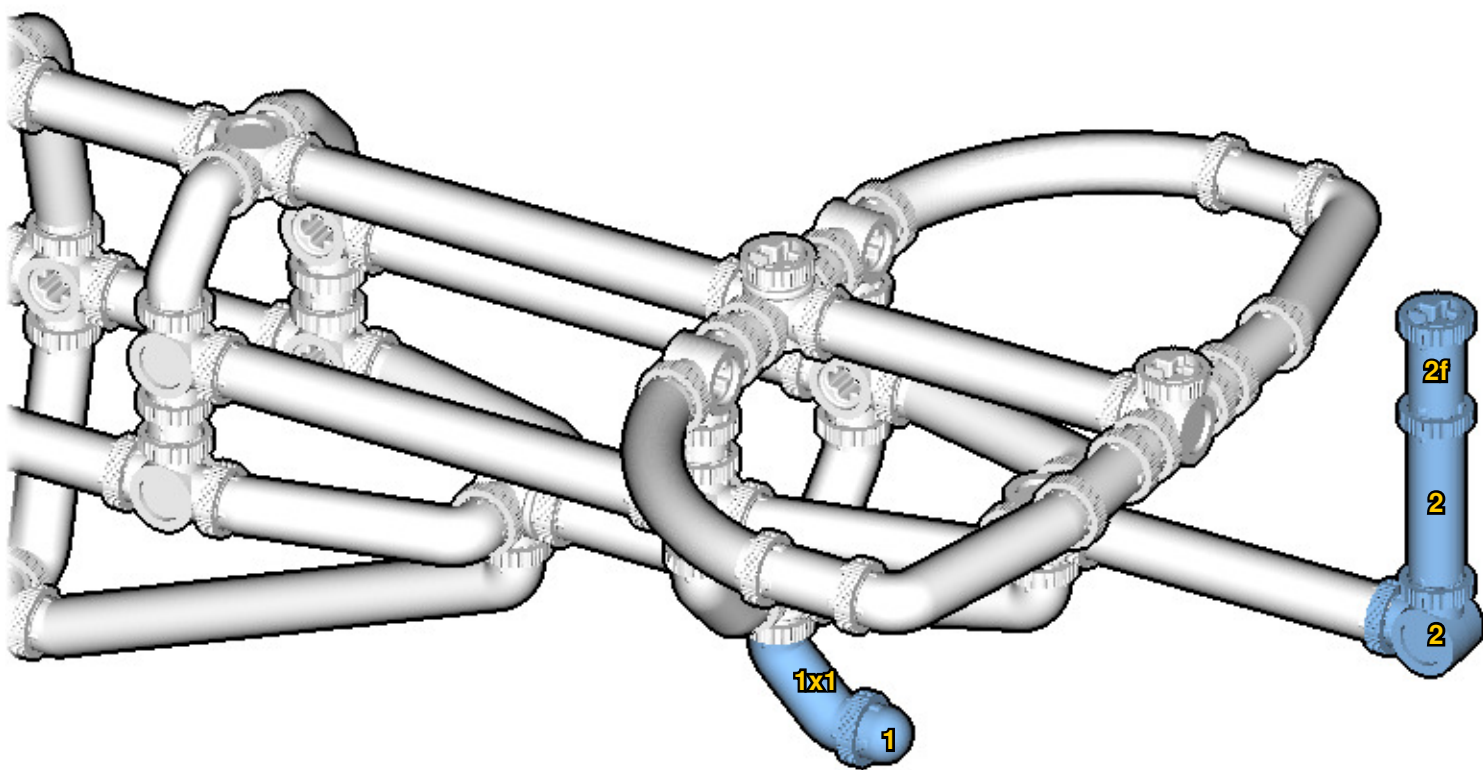
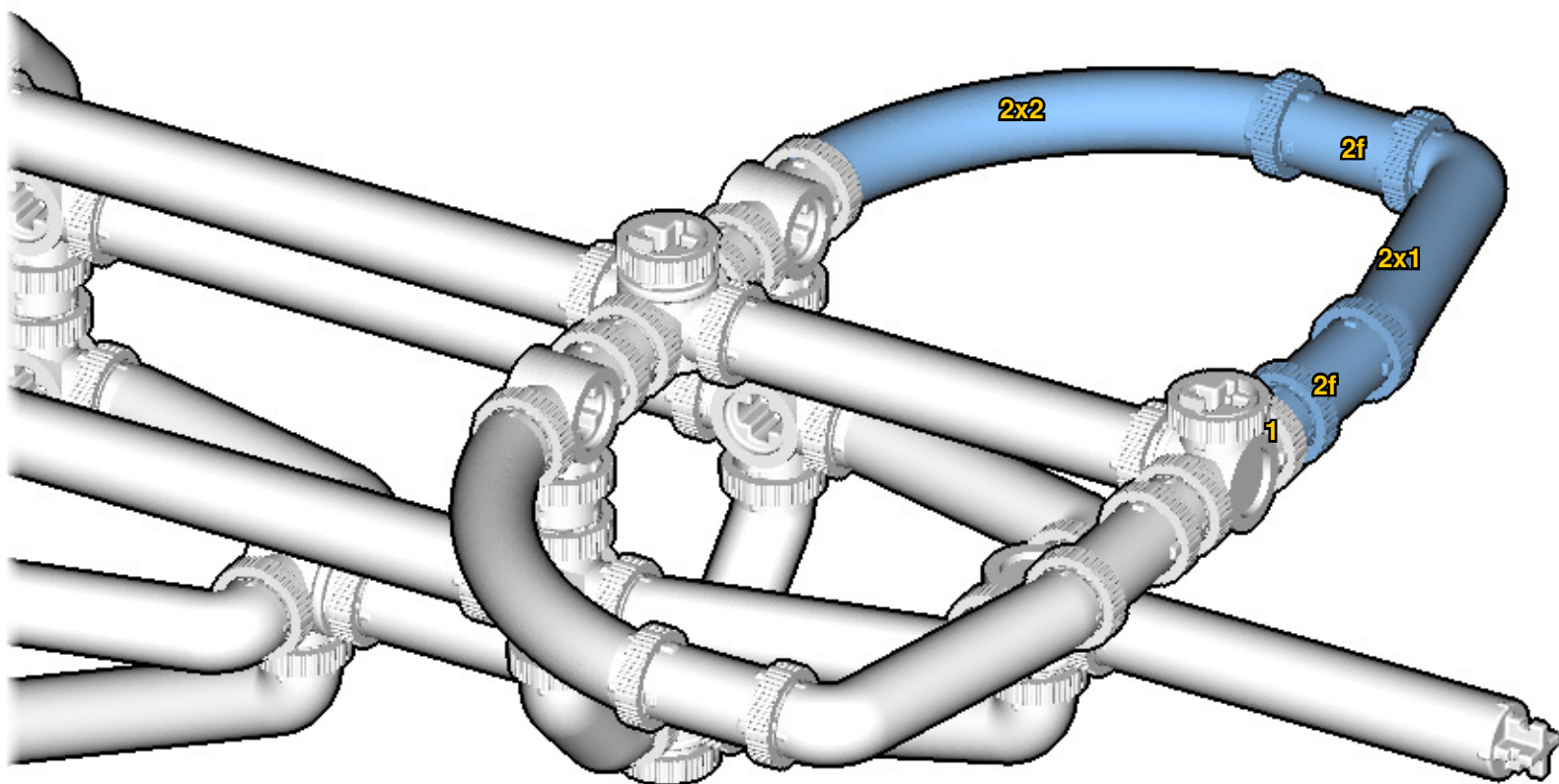

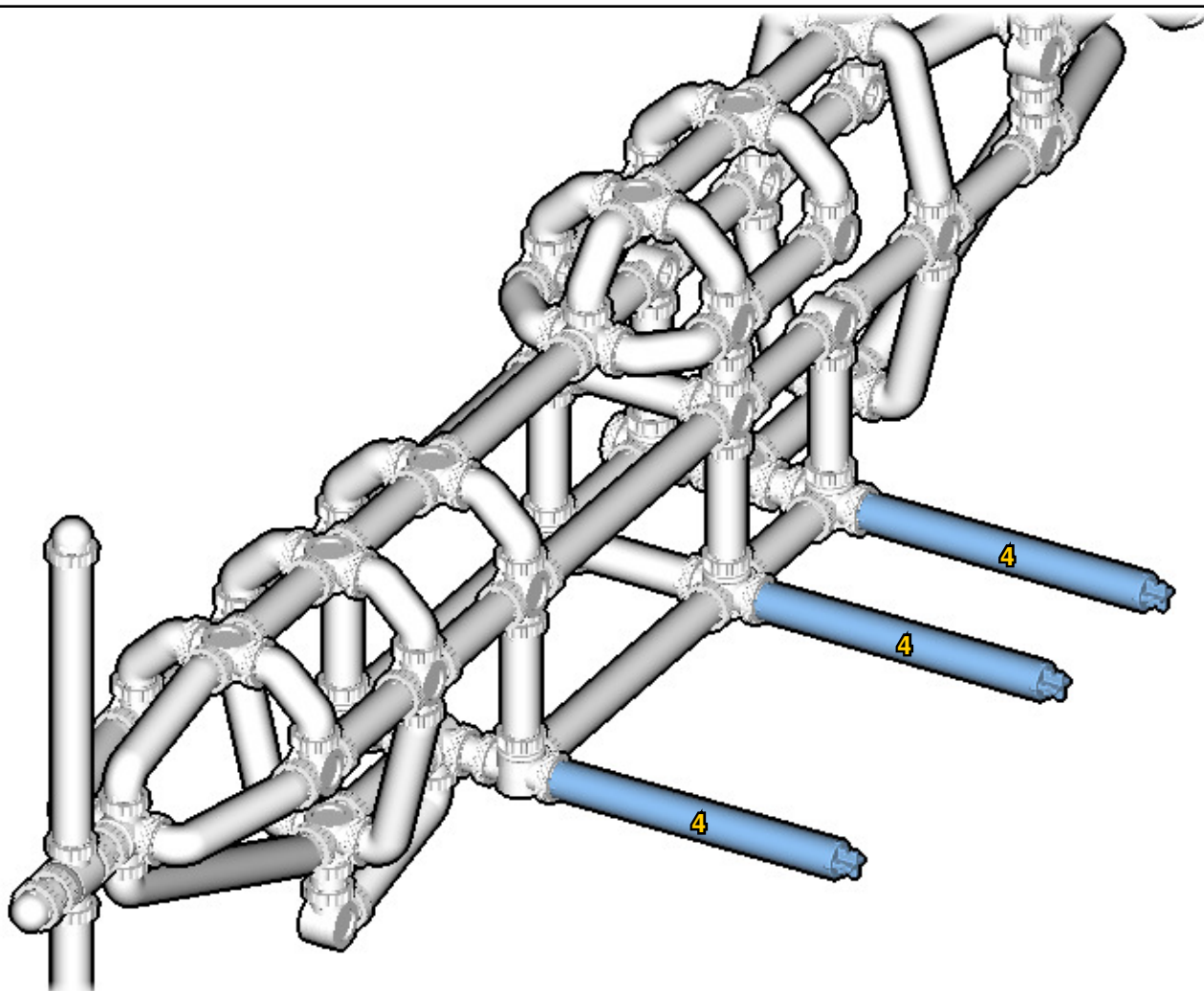
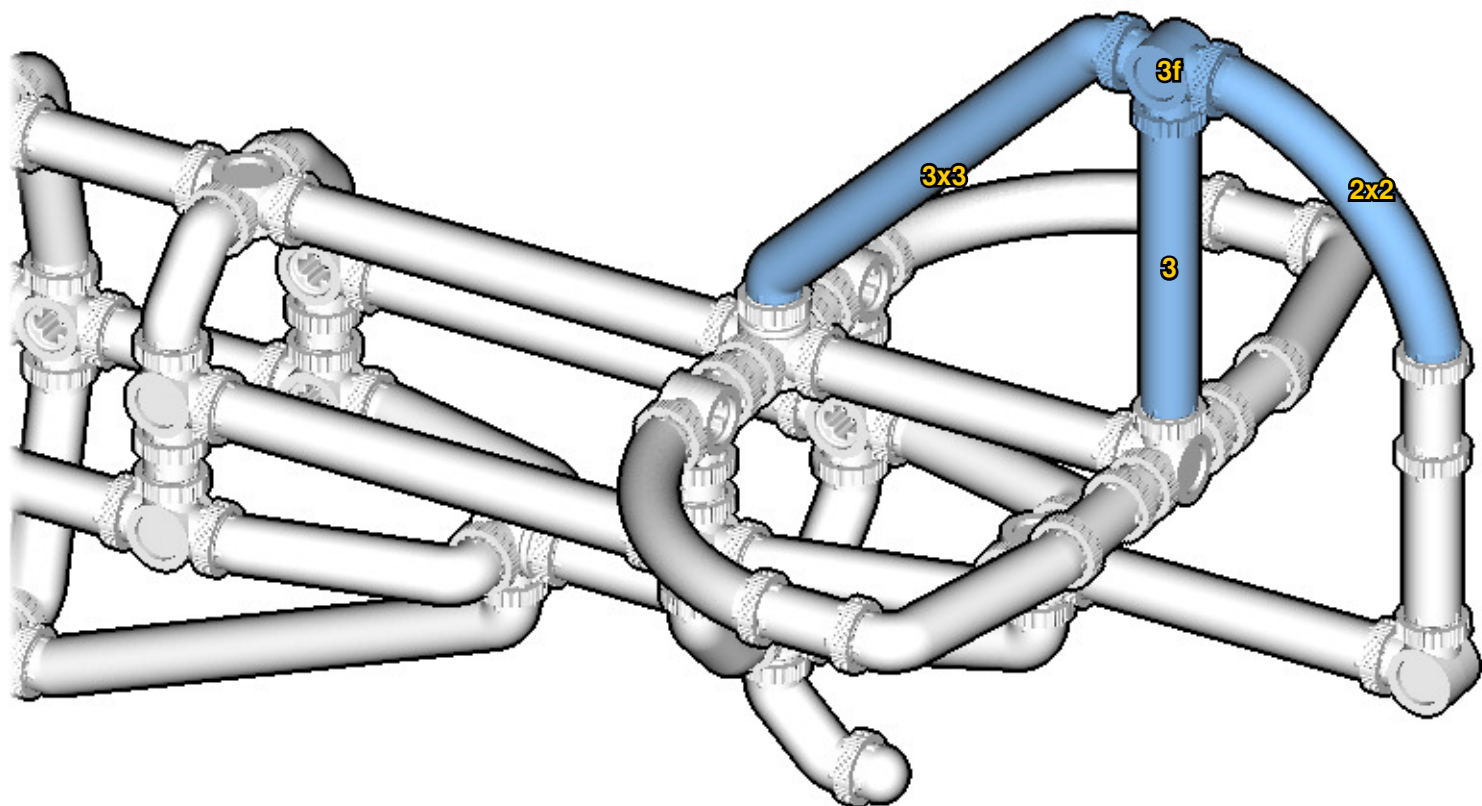

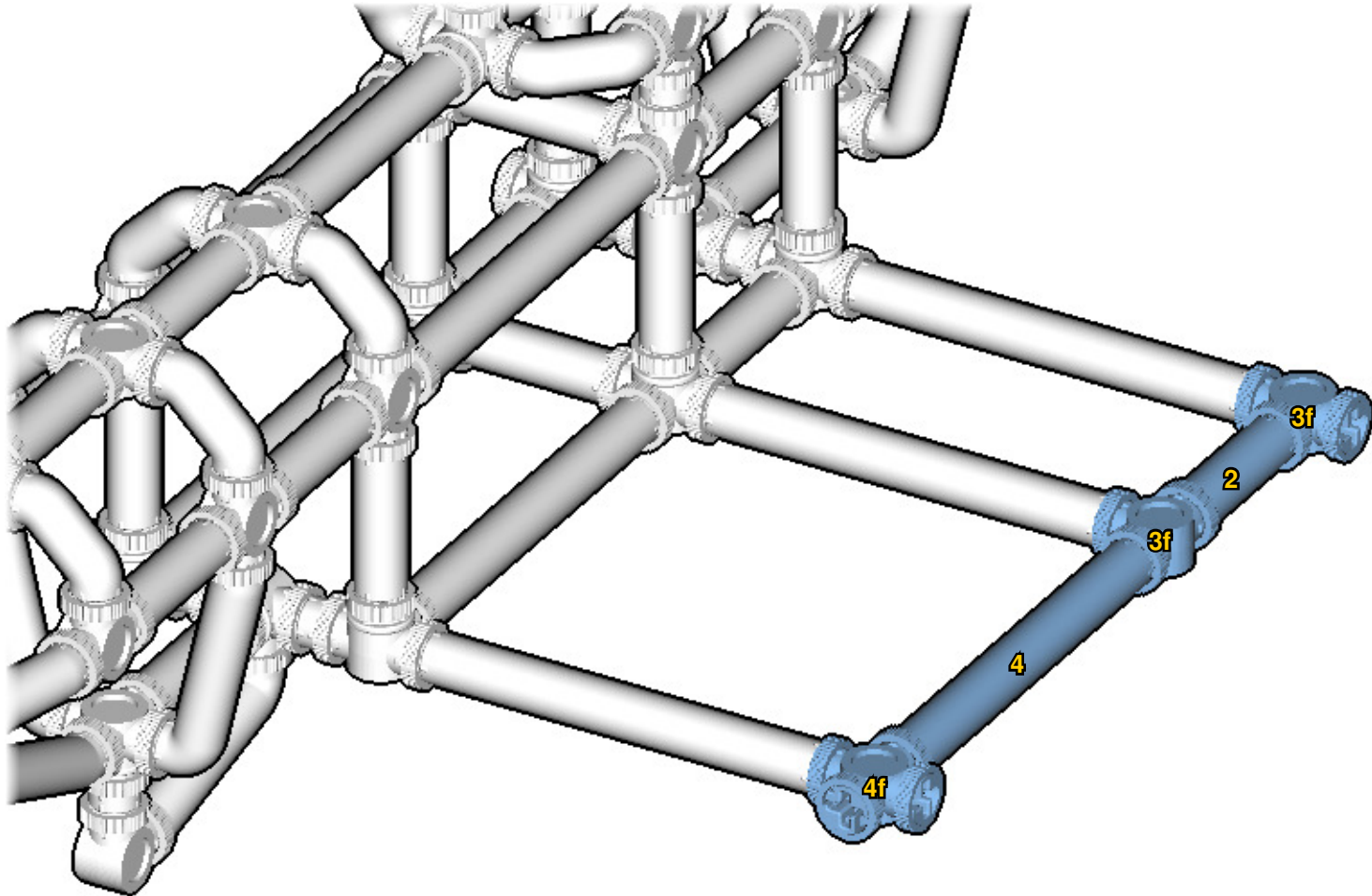
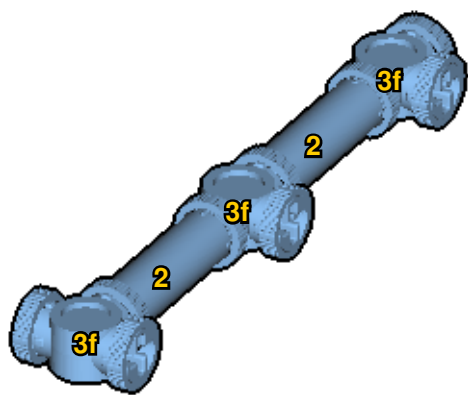
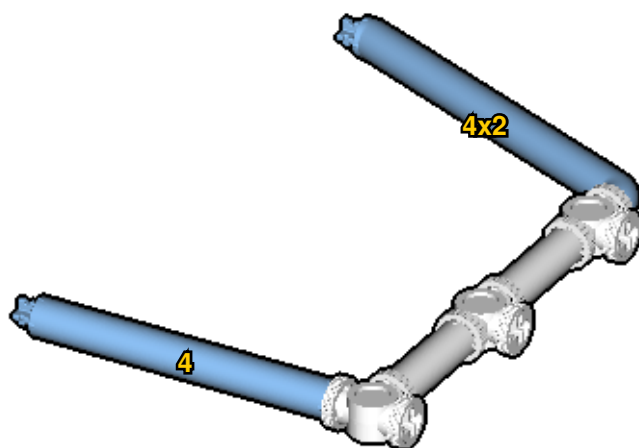
4748

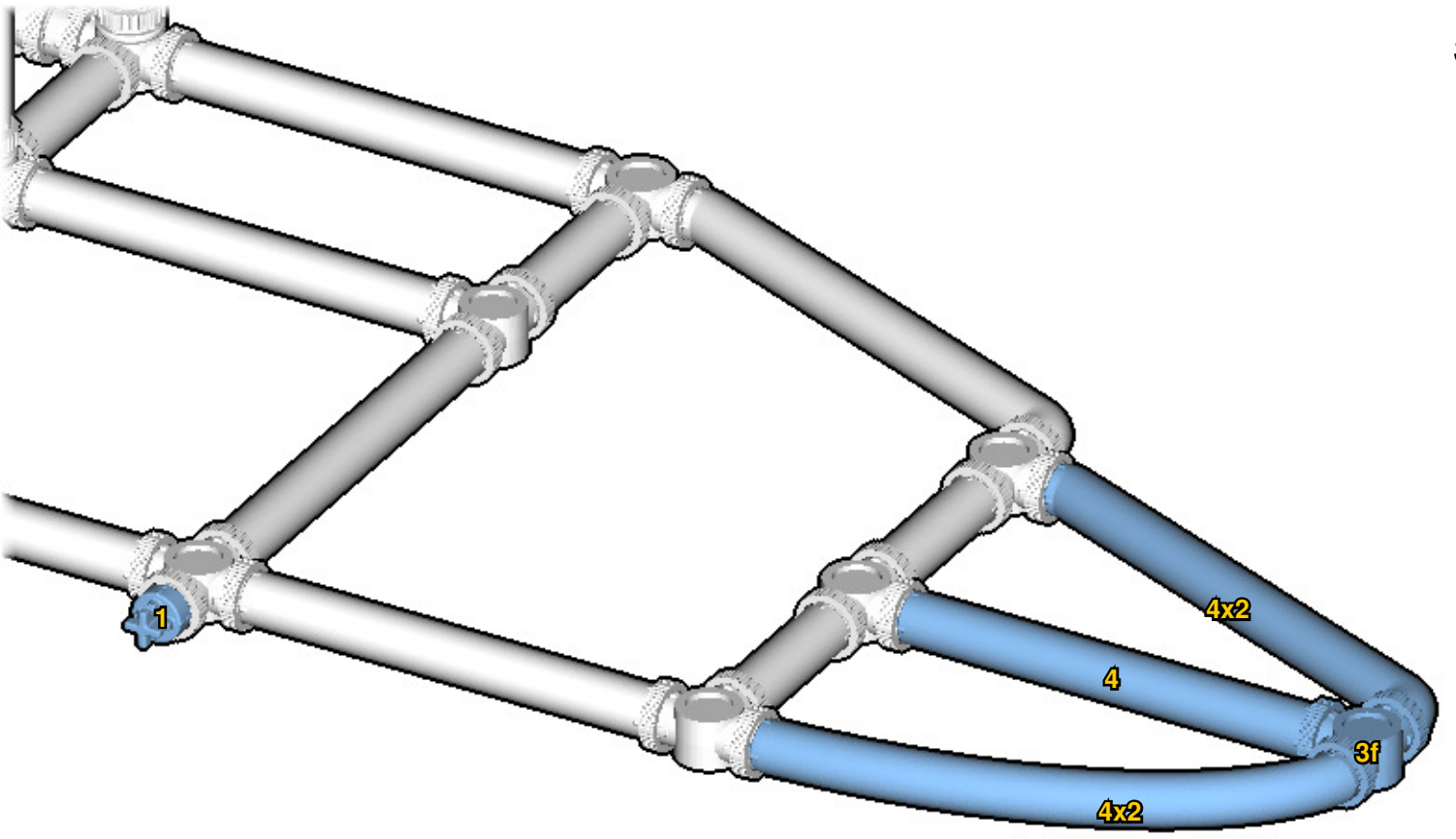
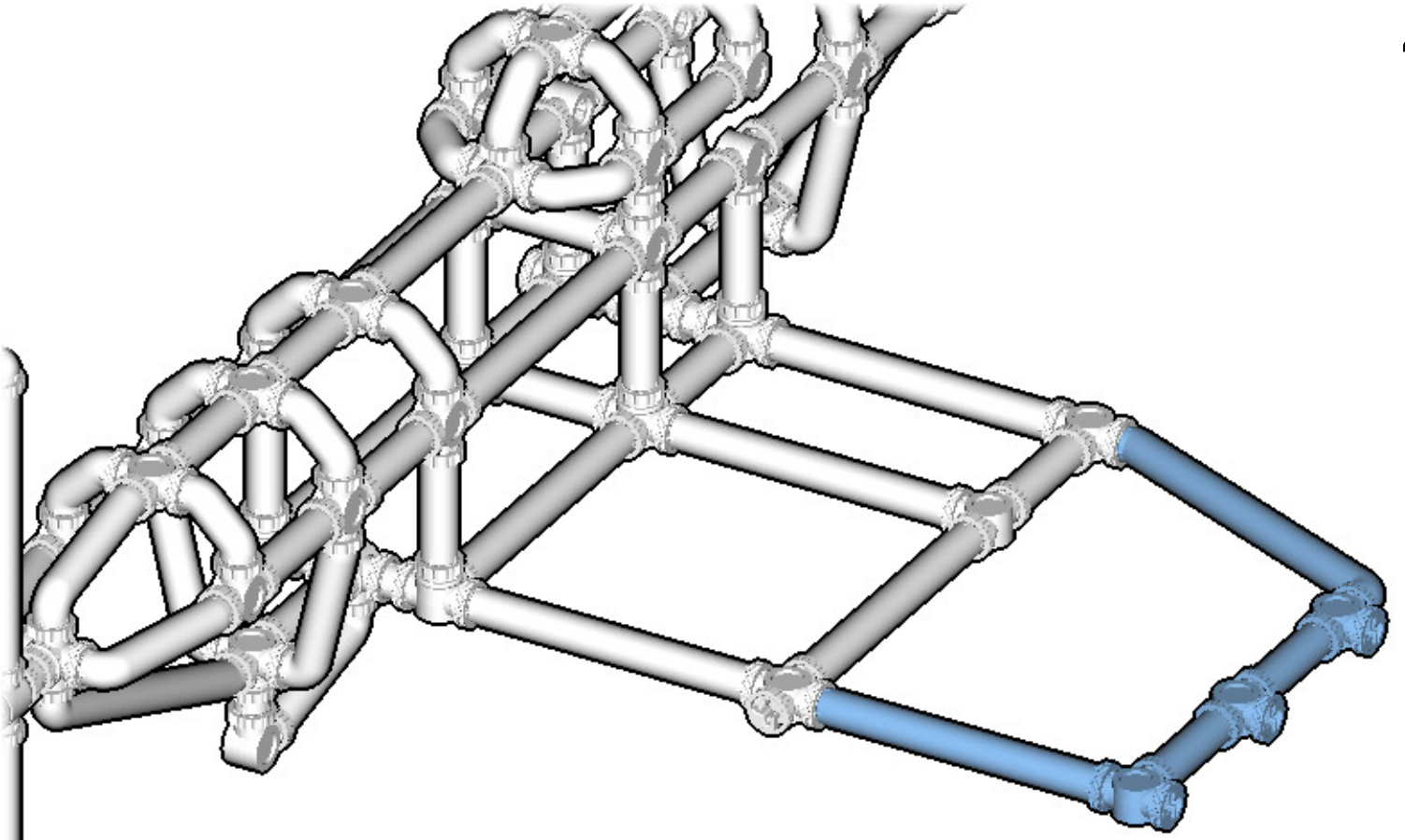

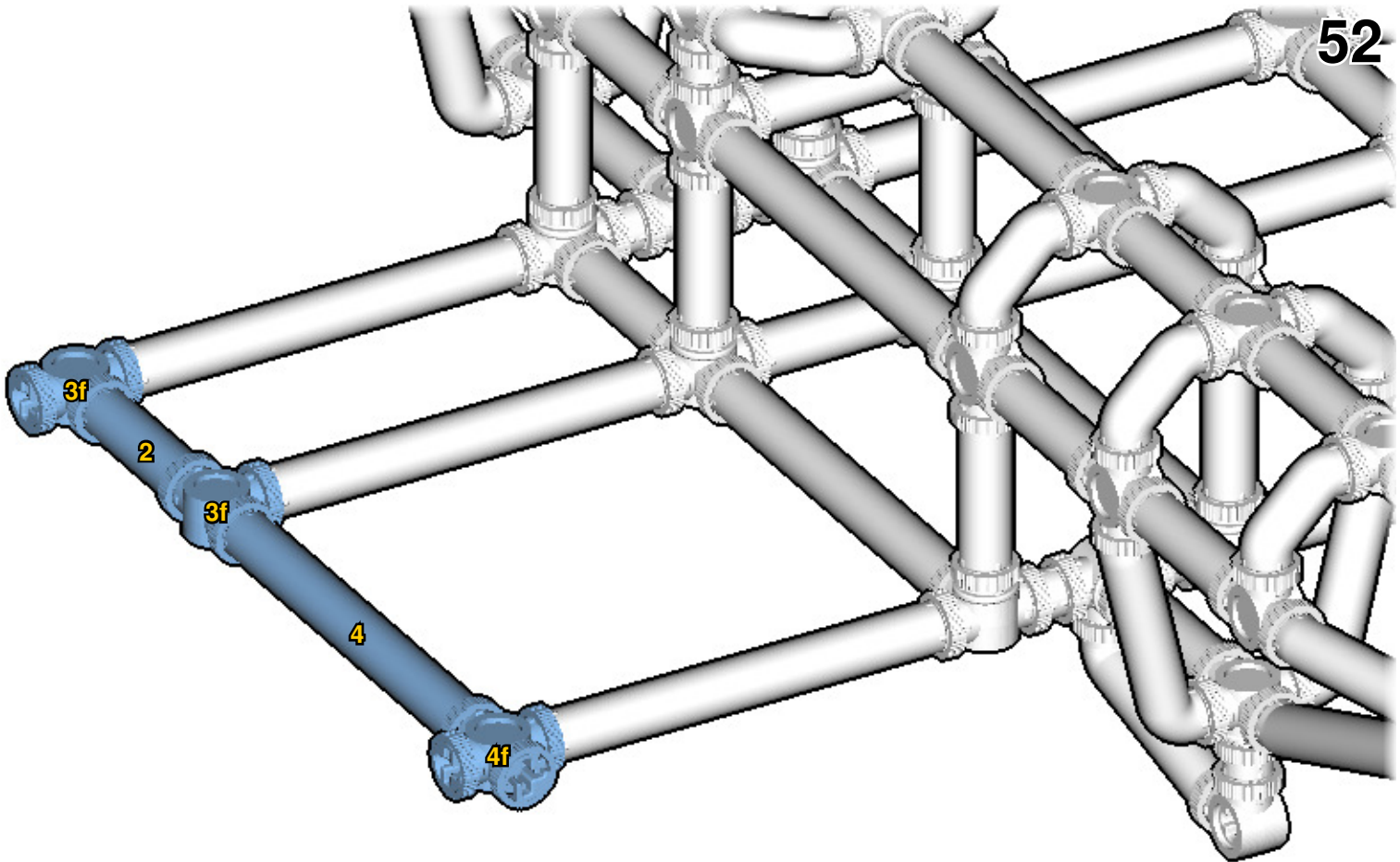
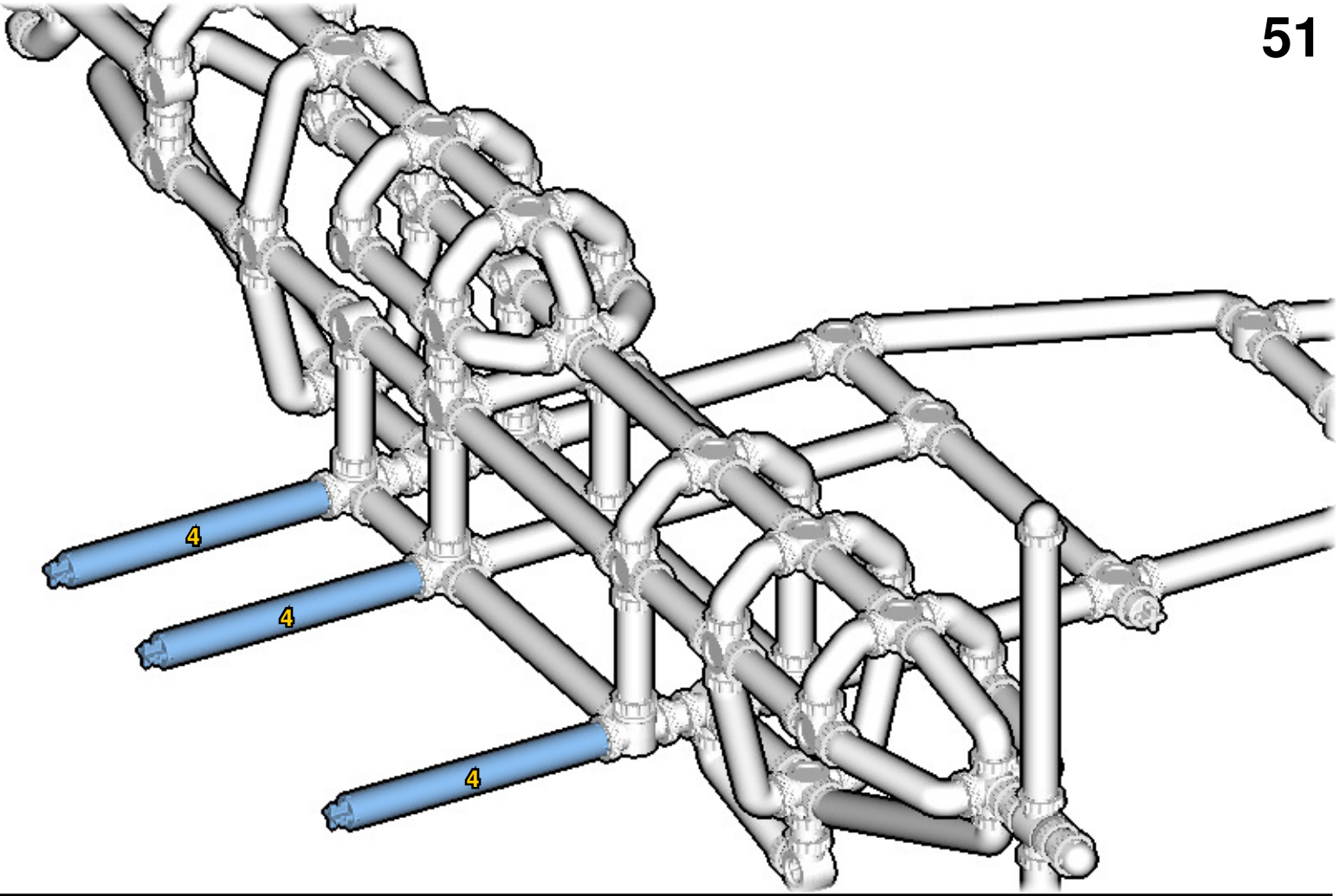

53

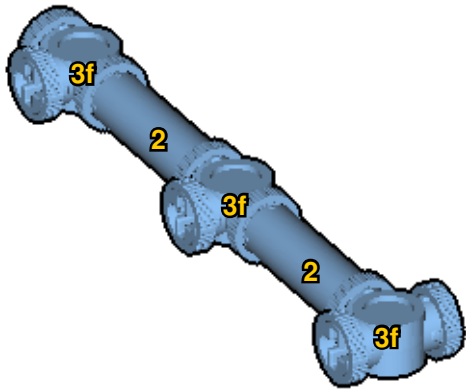

54

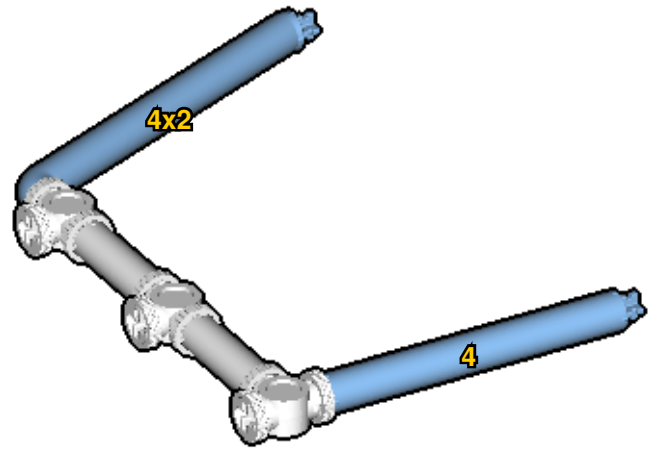

55

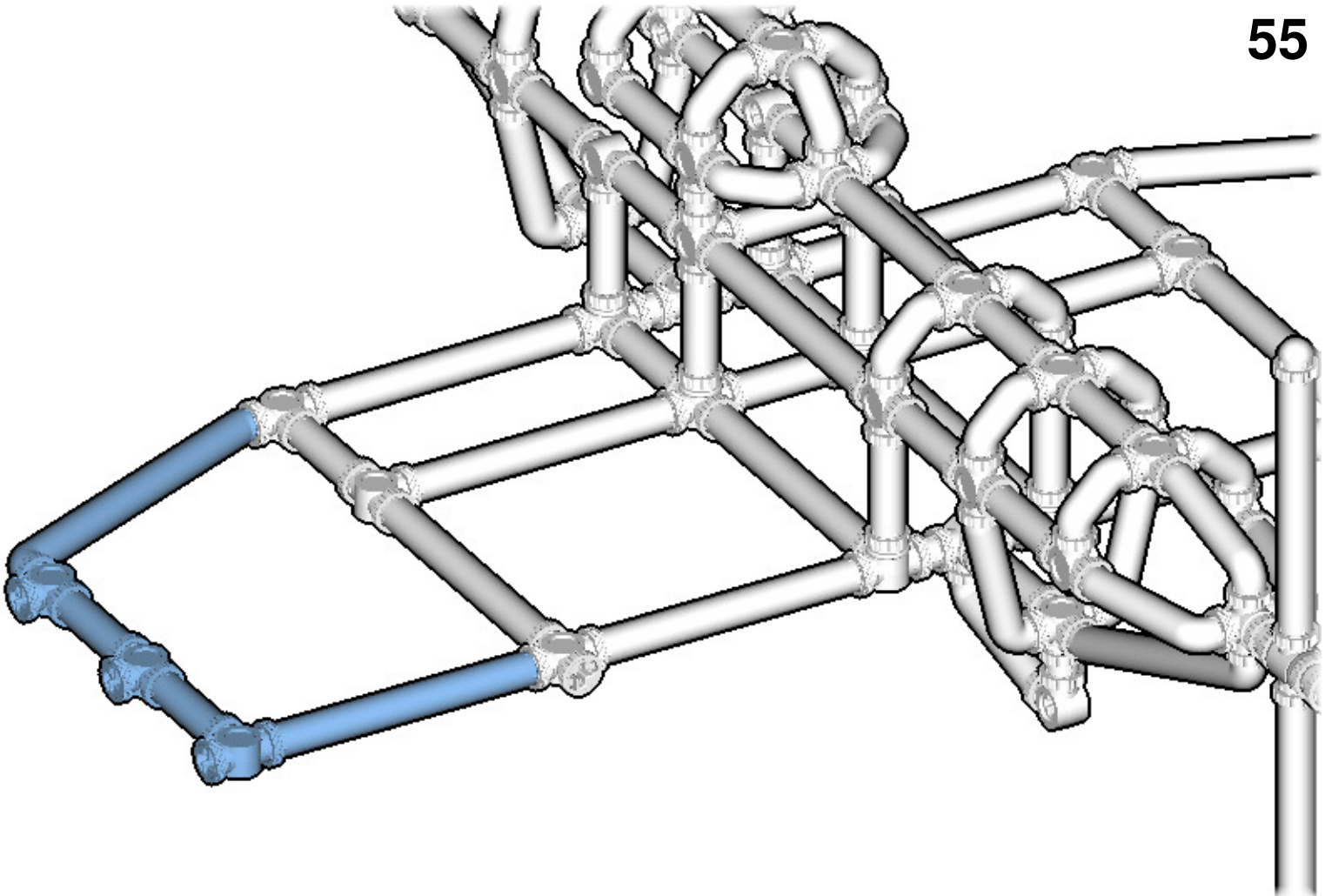

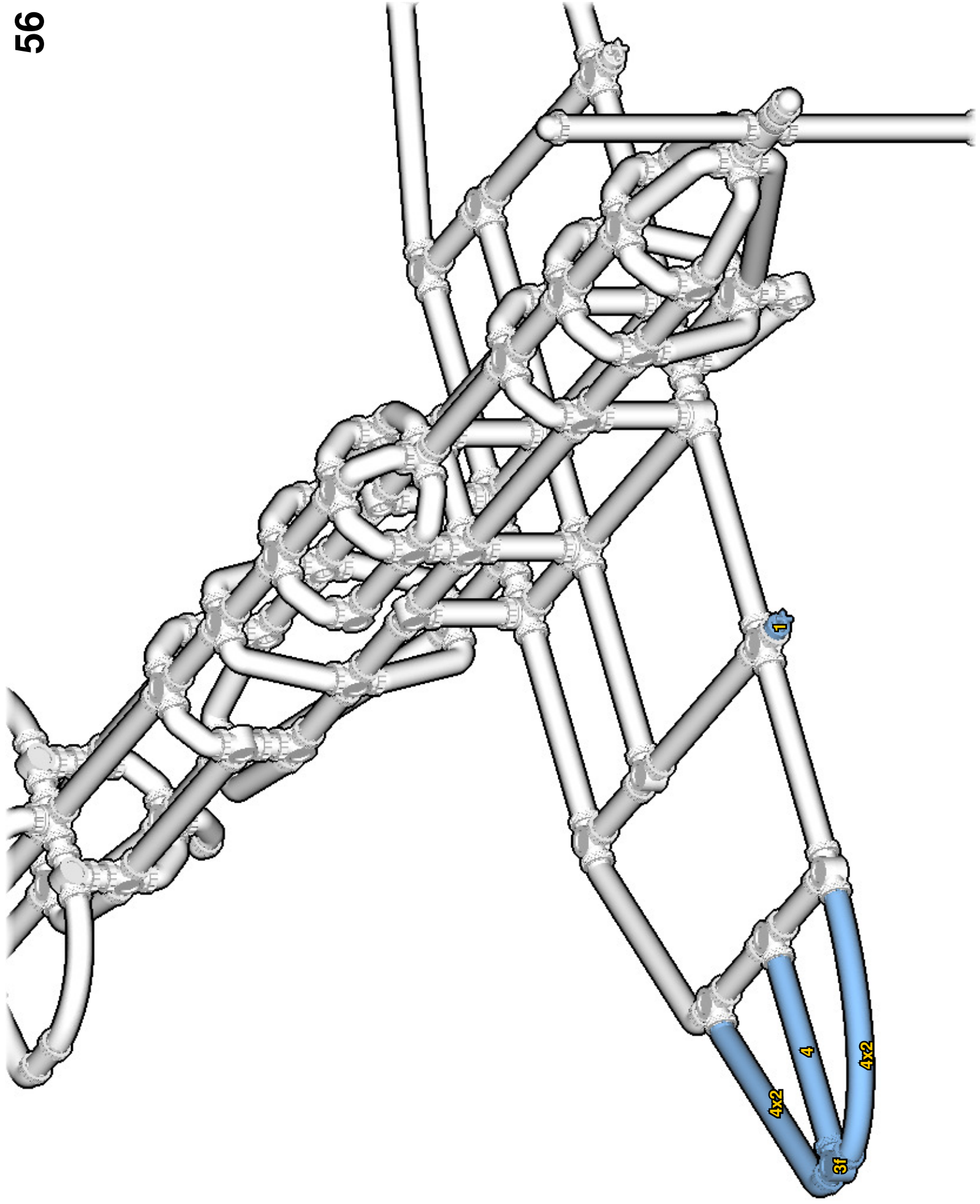

INVENTORY

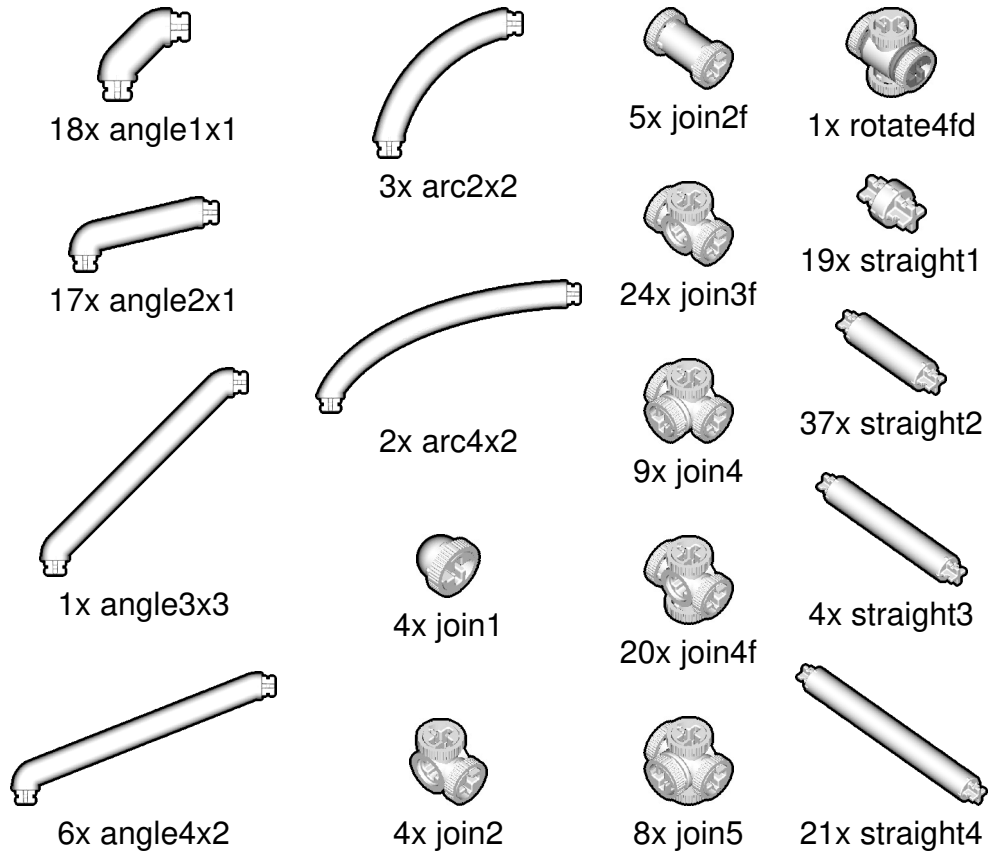

ACTUAL SIZE

