

HORSE

SIZE	1.9ft x 1.7ft x 0.4ft	PIECES	431
DESIGNER	Charles Sharman	MADE IN	U.S.A.



Wrong
Connecting/Disconnecting Two Directions



Right
Connecting/Disconnecting One Direction

1

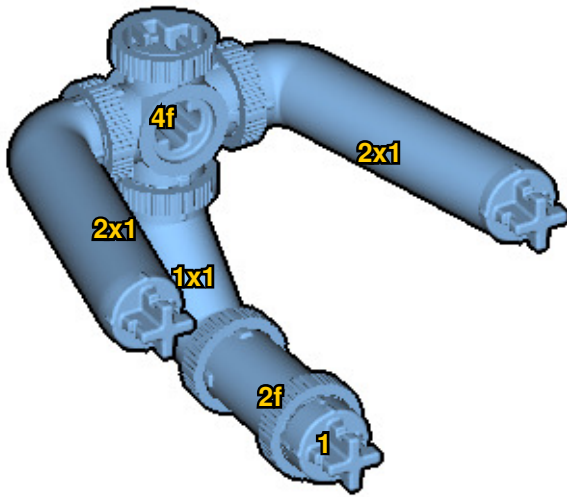

New pieces are drawn blue. Old pieces are drawn white.
See back for piece names.

2

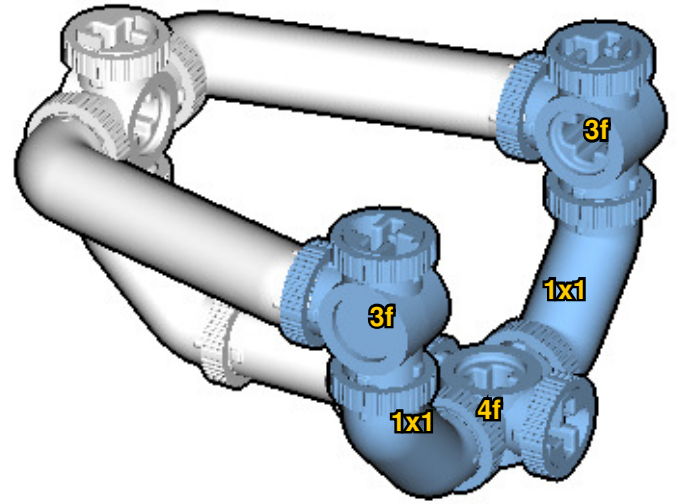

Connect new pieces together before connecting to old pieces.

3

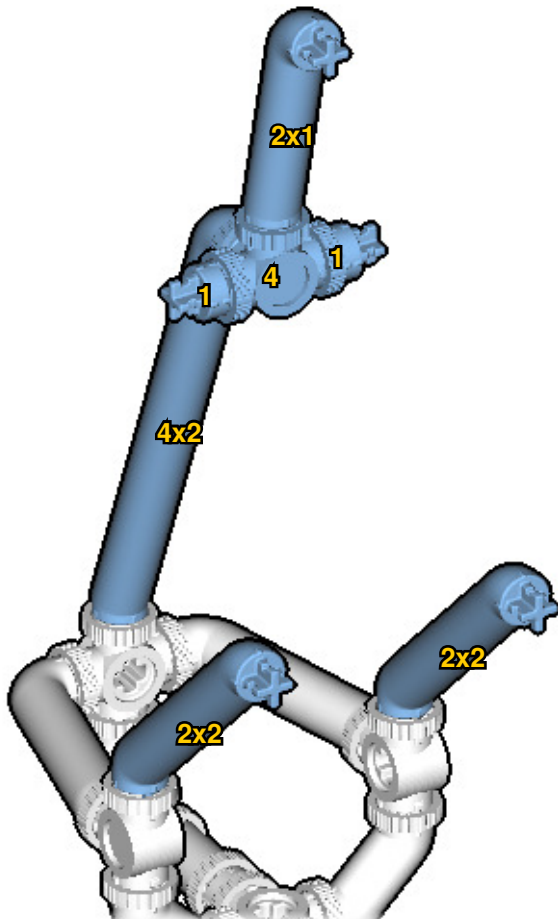

4

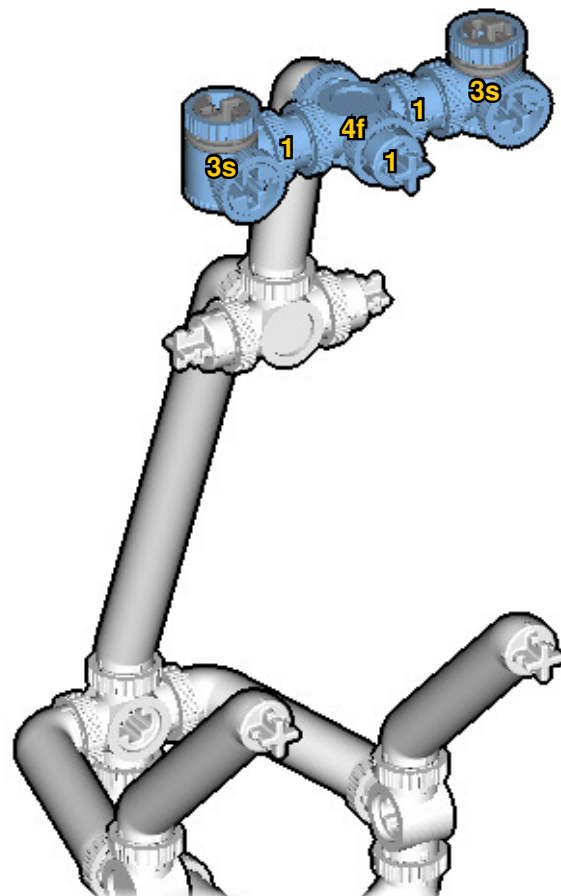

5

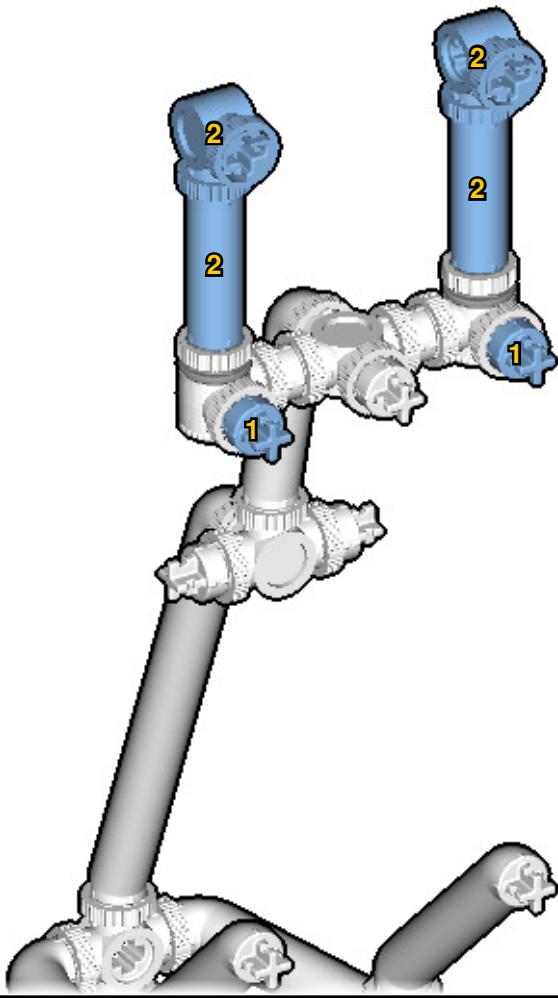

Submodel begins → 6

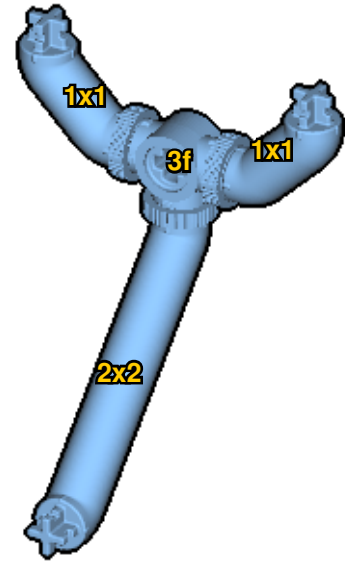

7

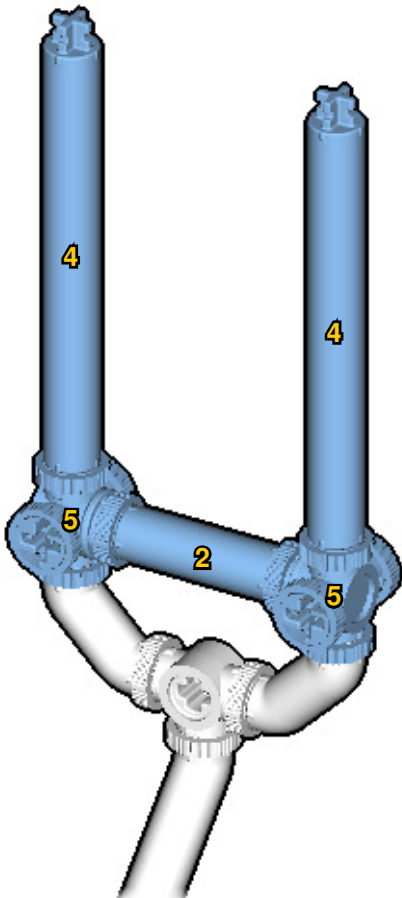

8

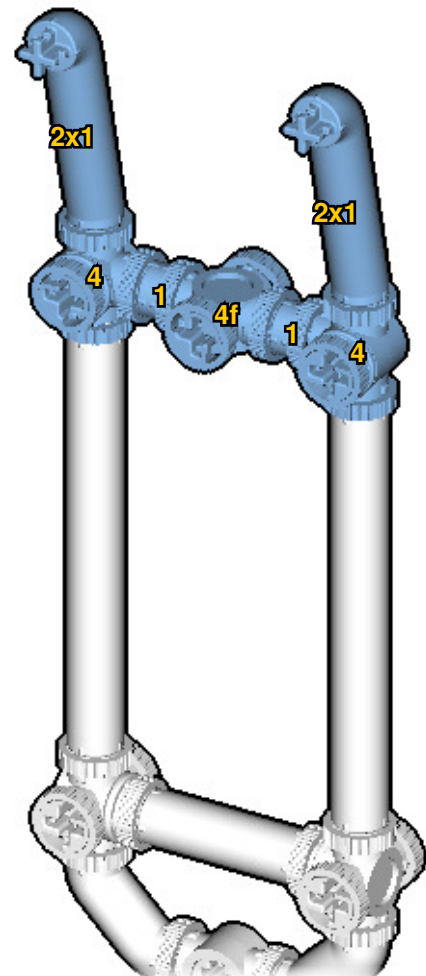

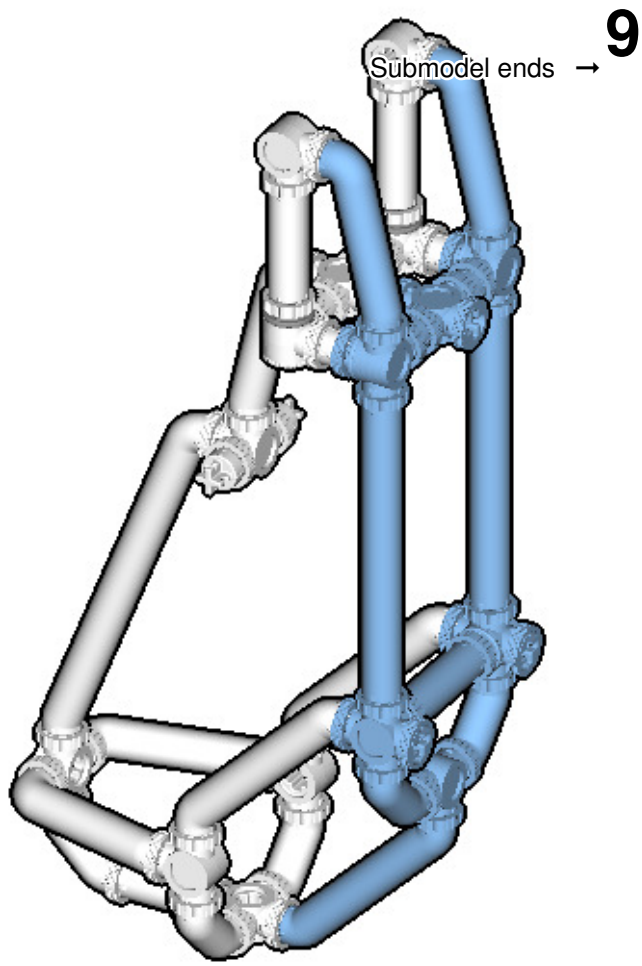

Connect submodel to model.

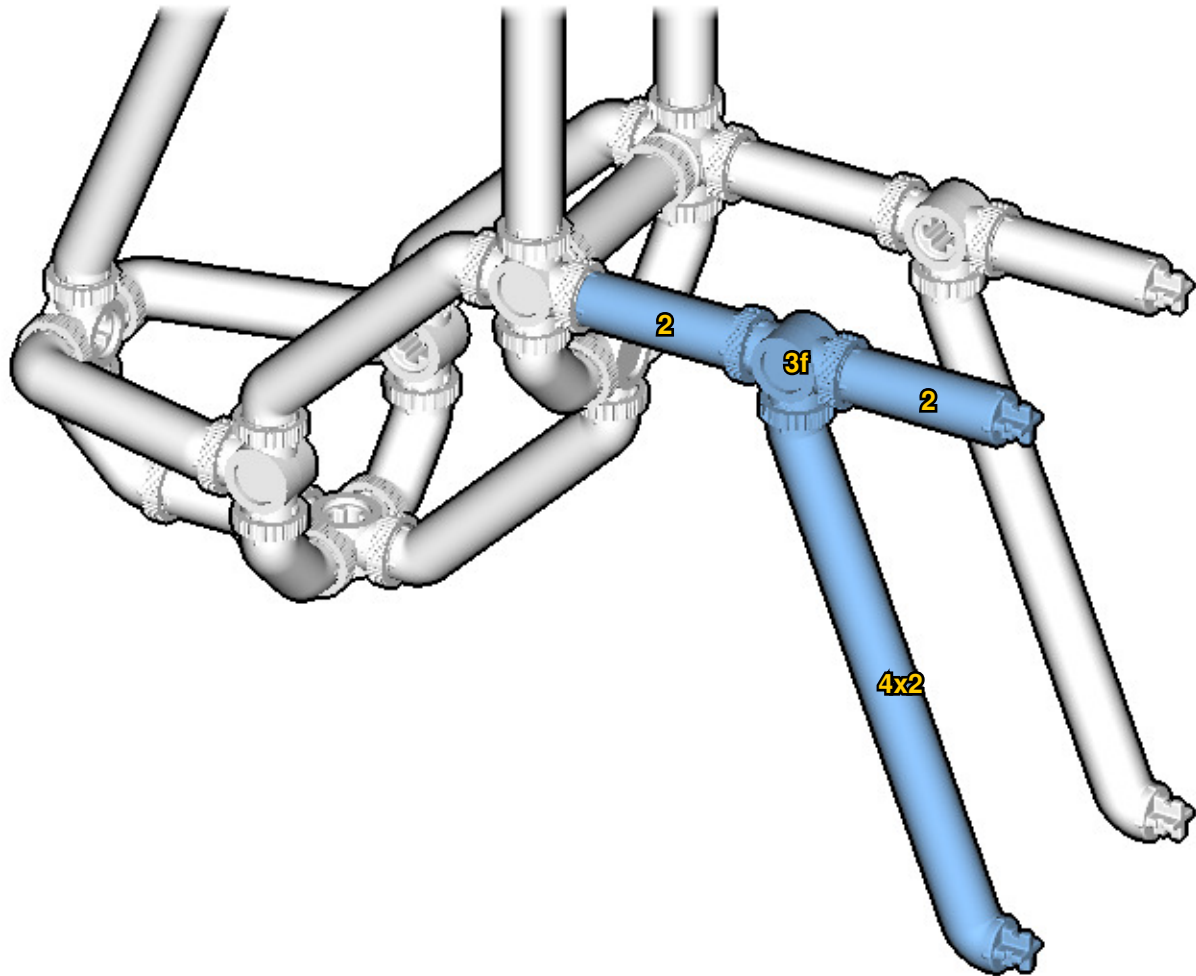
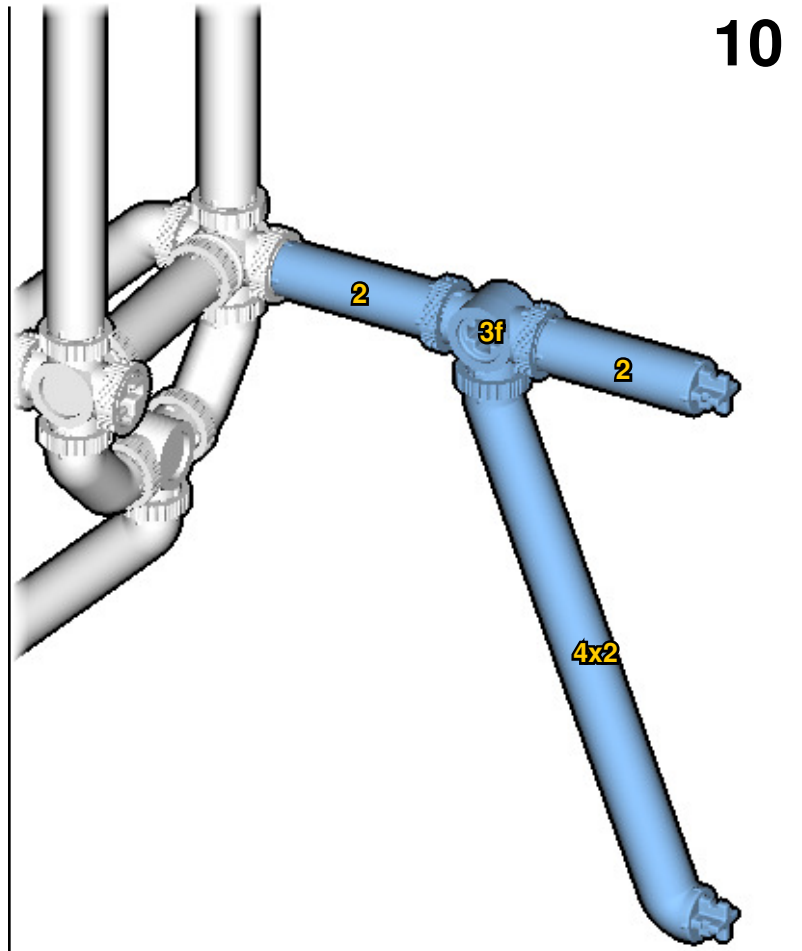

12

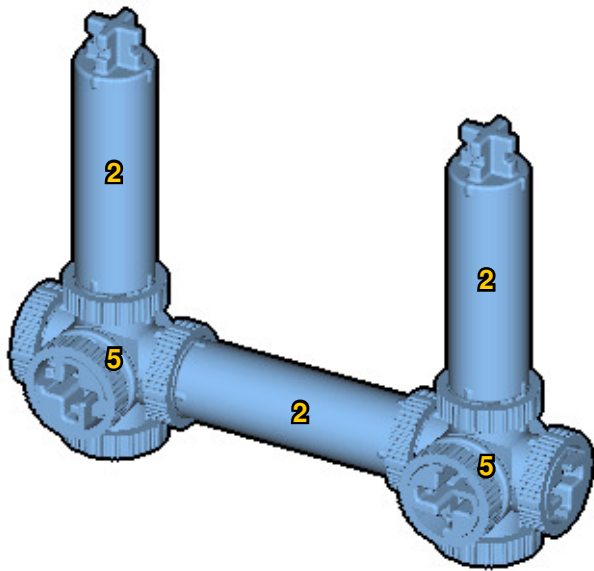

13

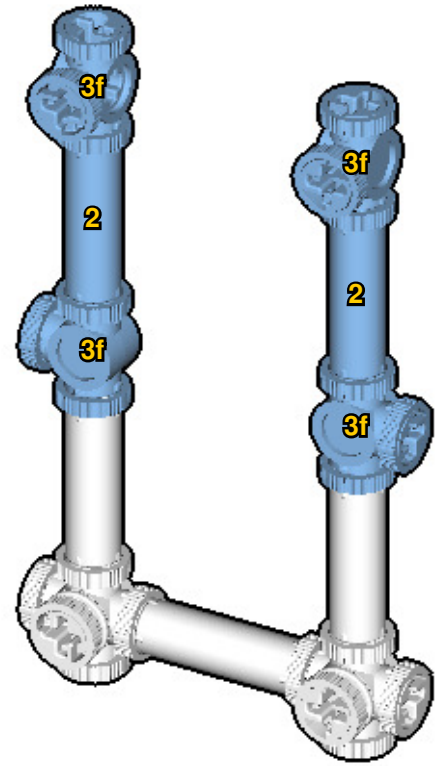

14

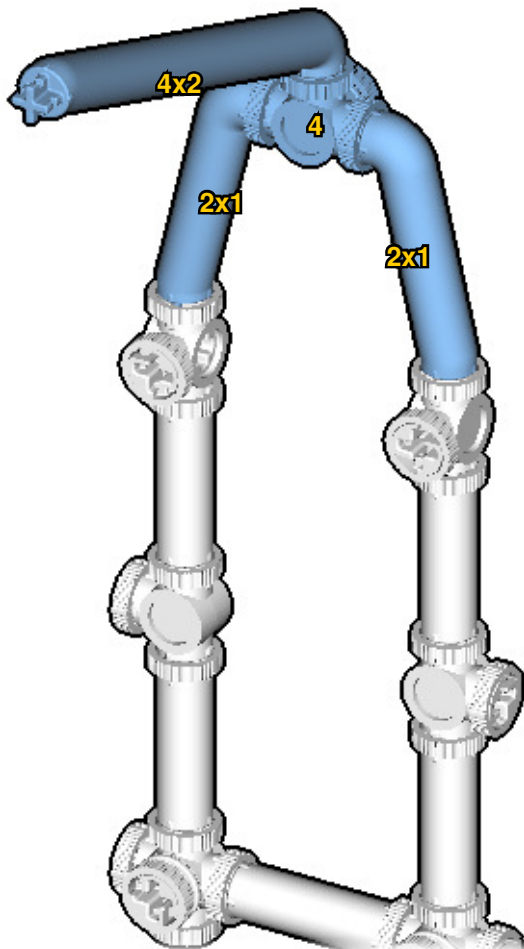

15

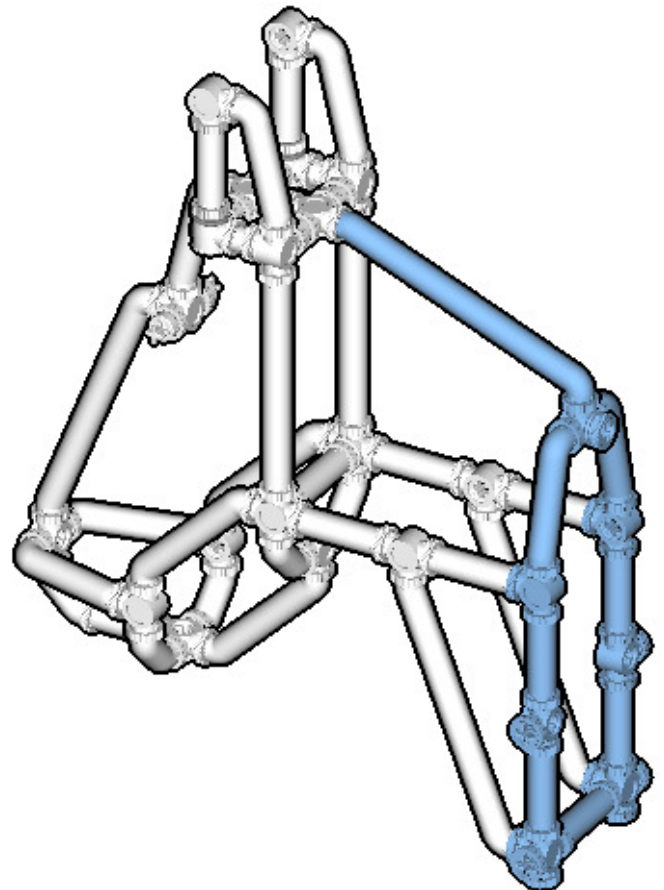

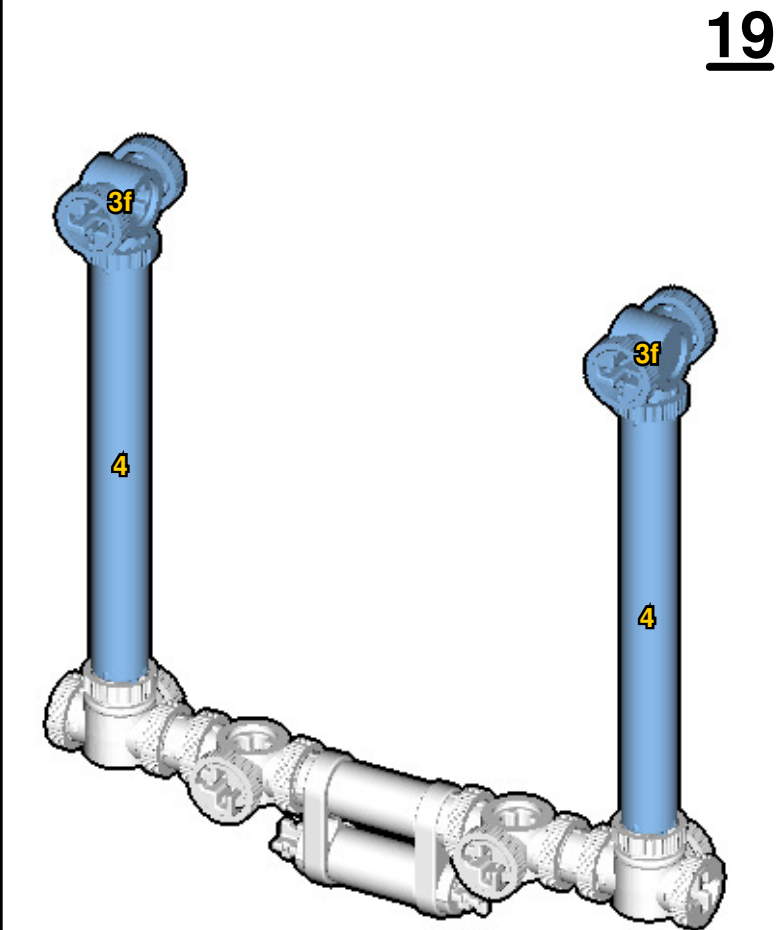
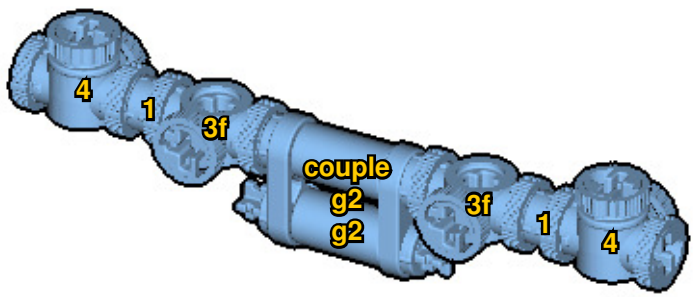
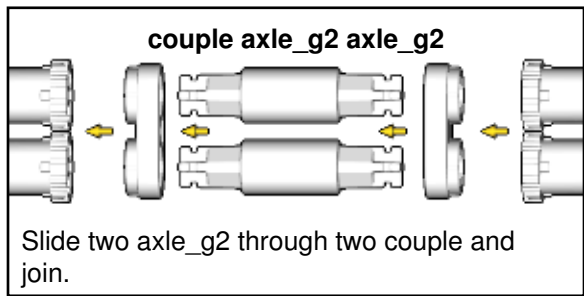
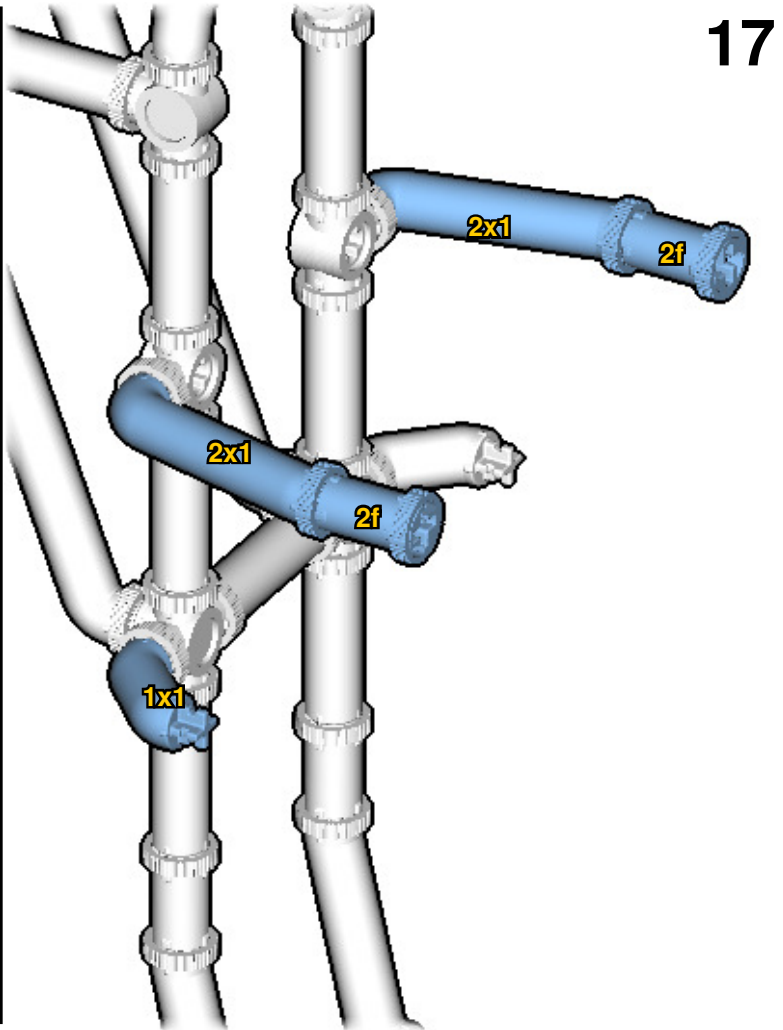
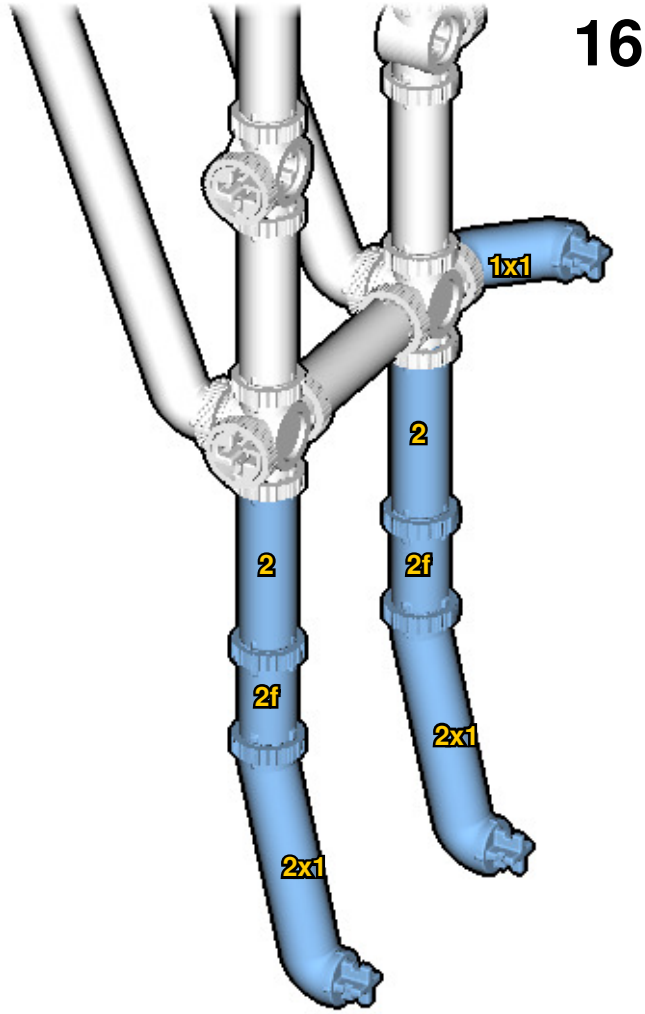

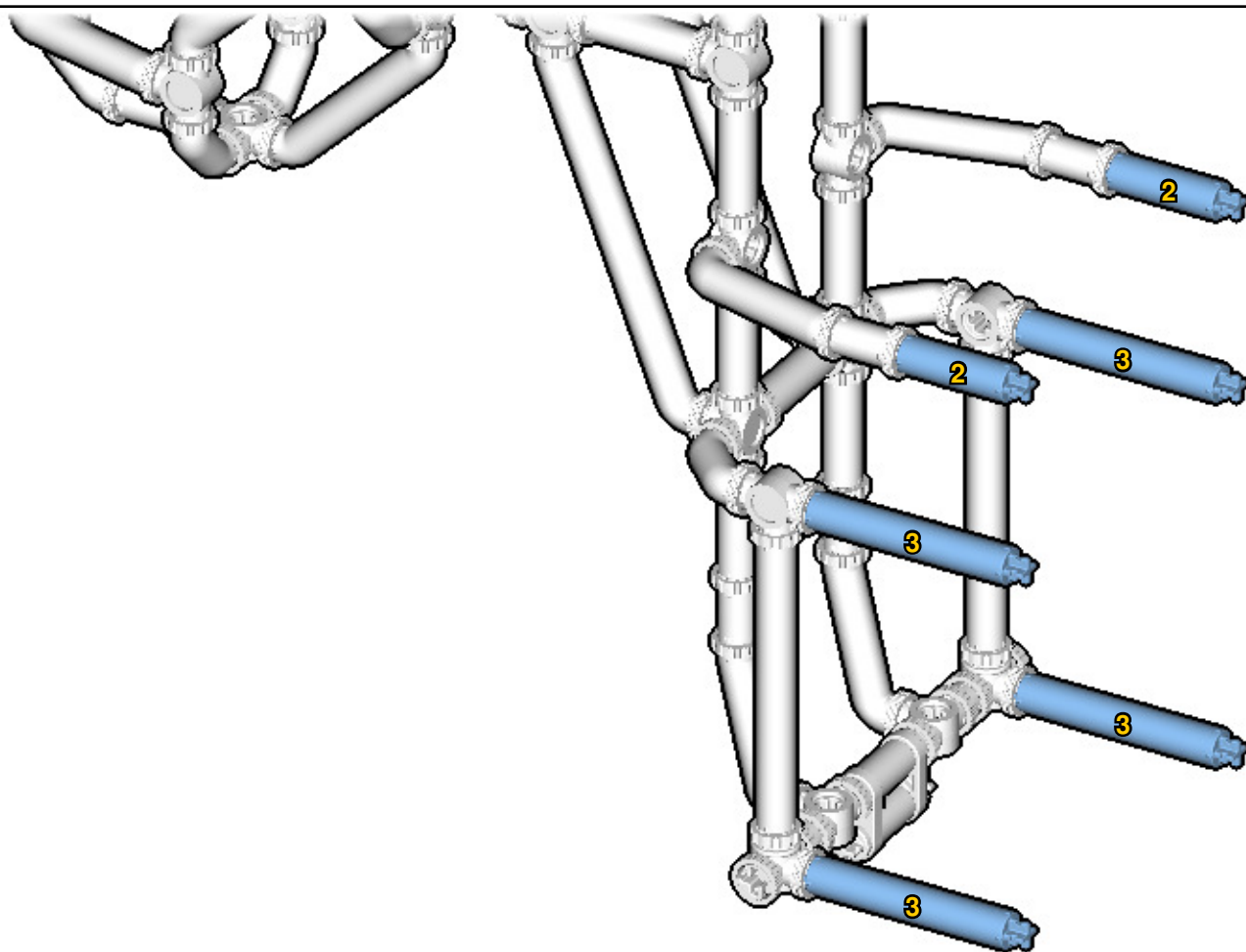
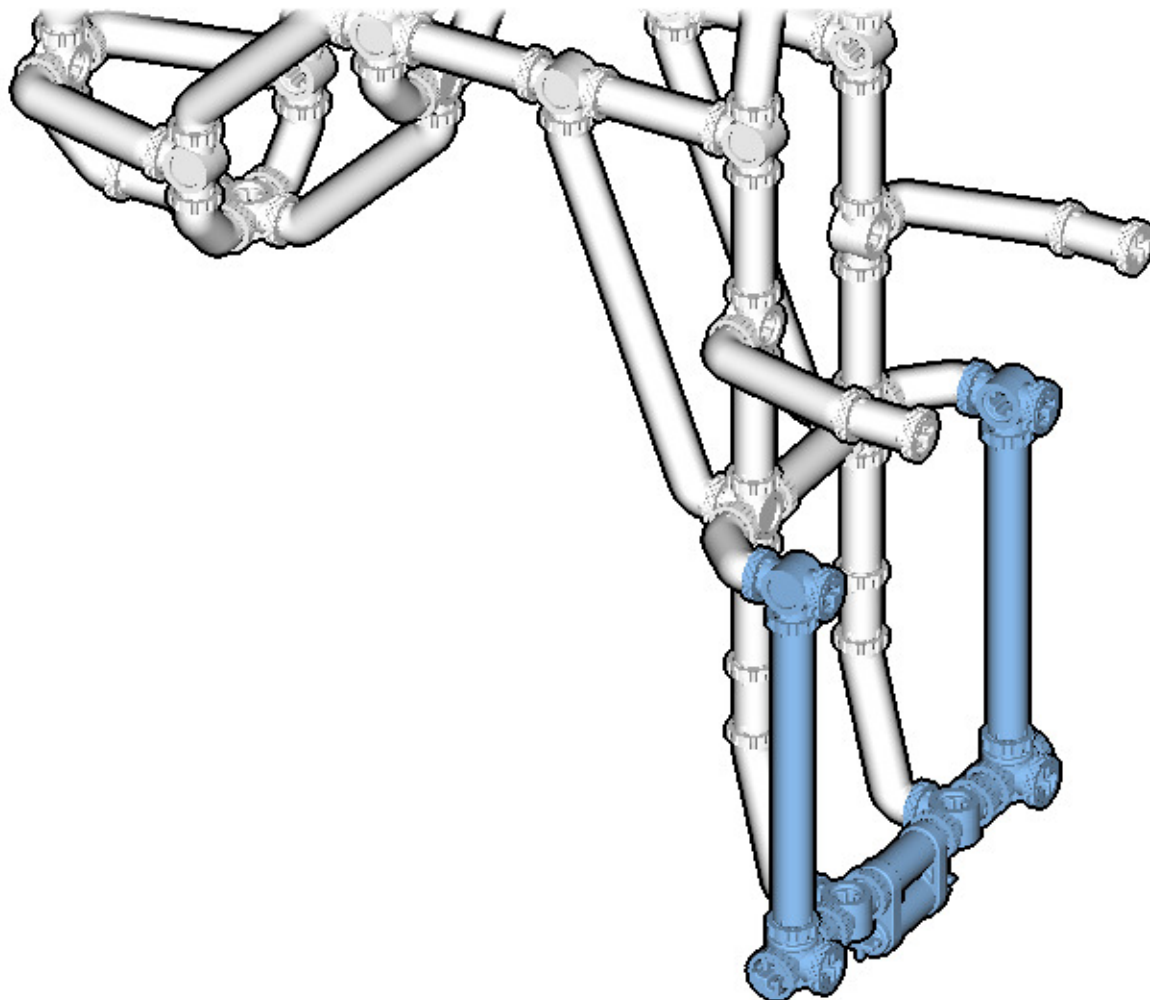

22

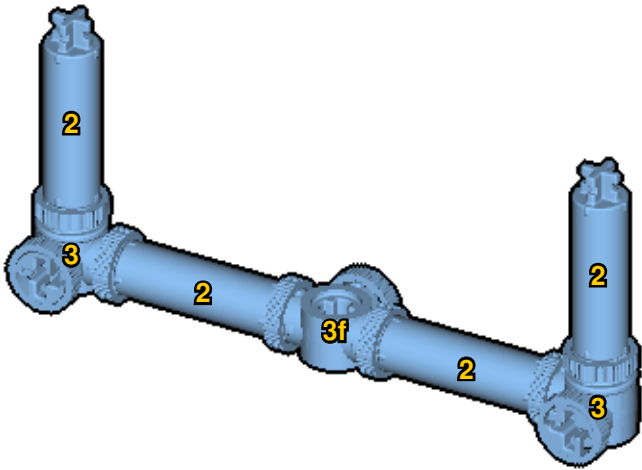

23

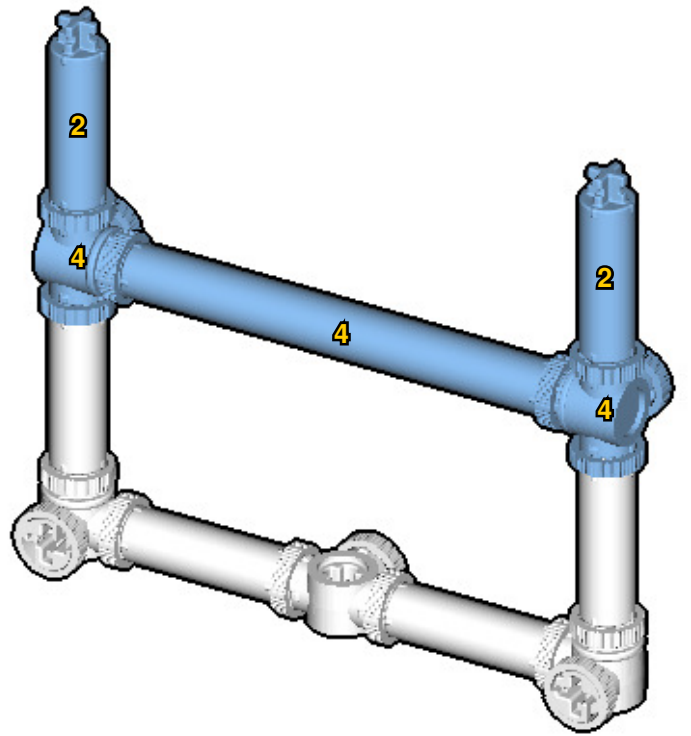

24

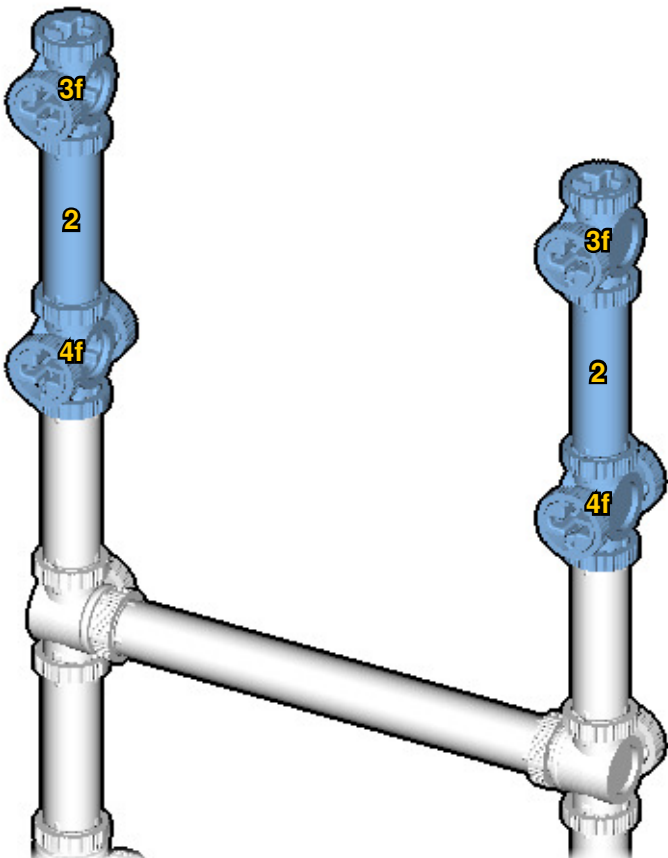

25

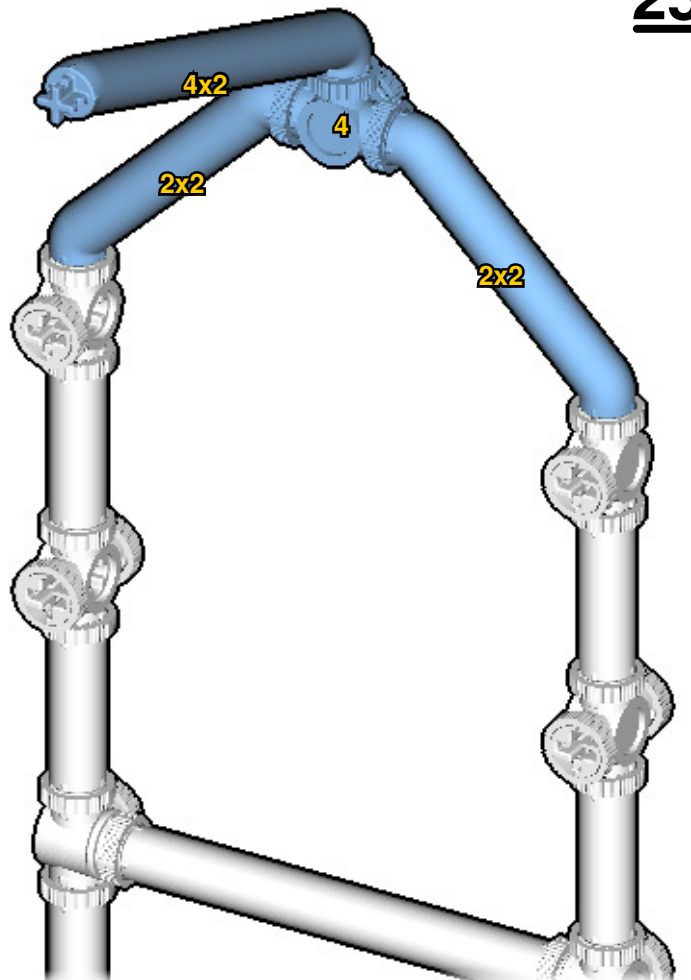

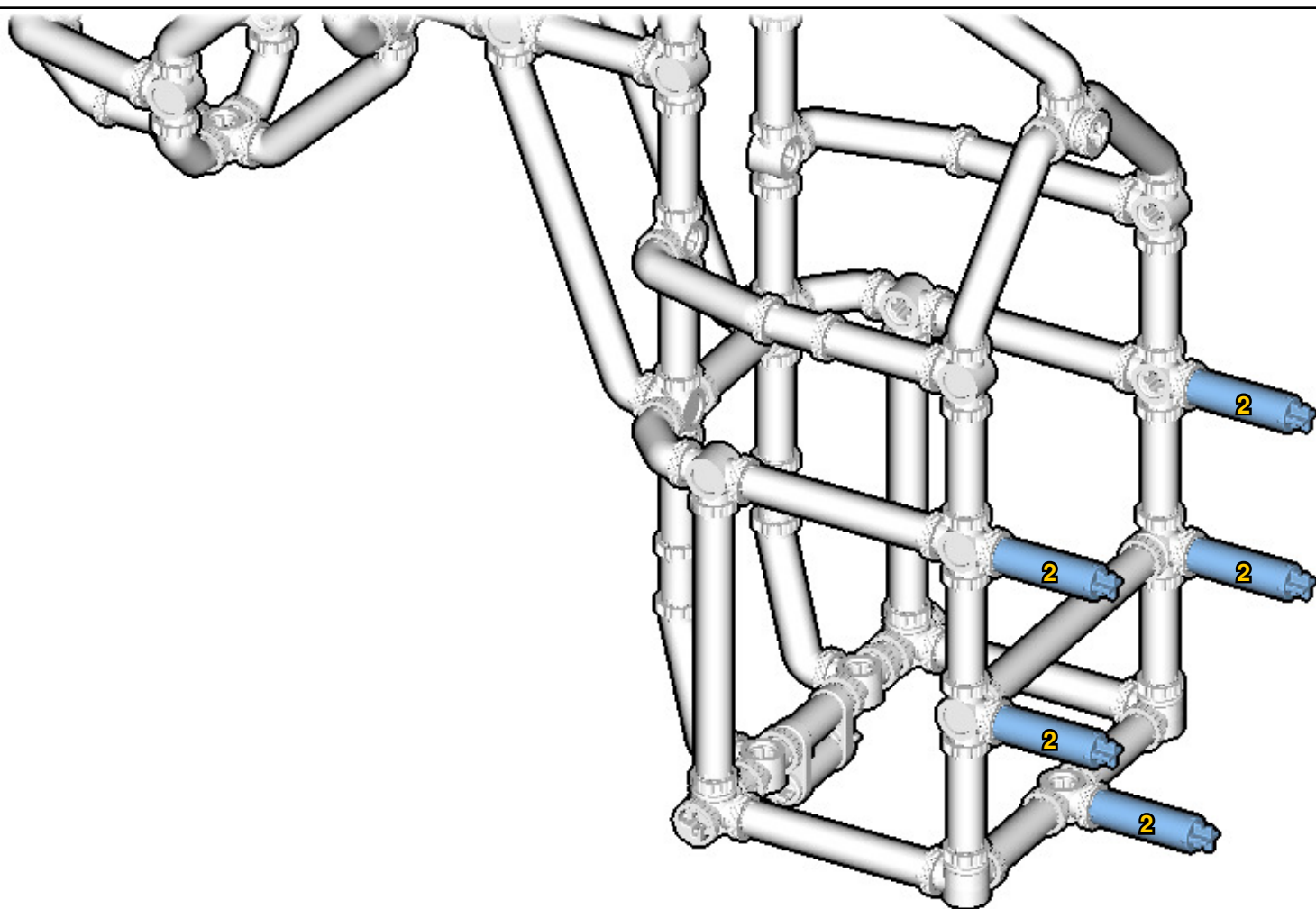
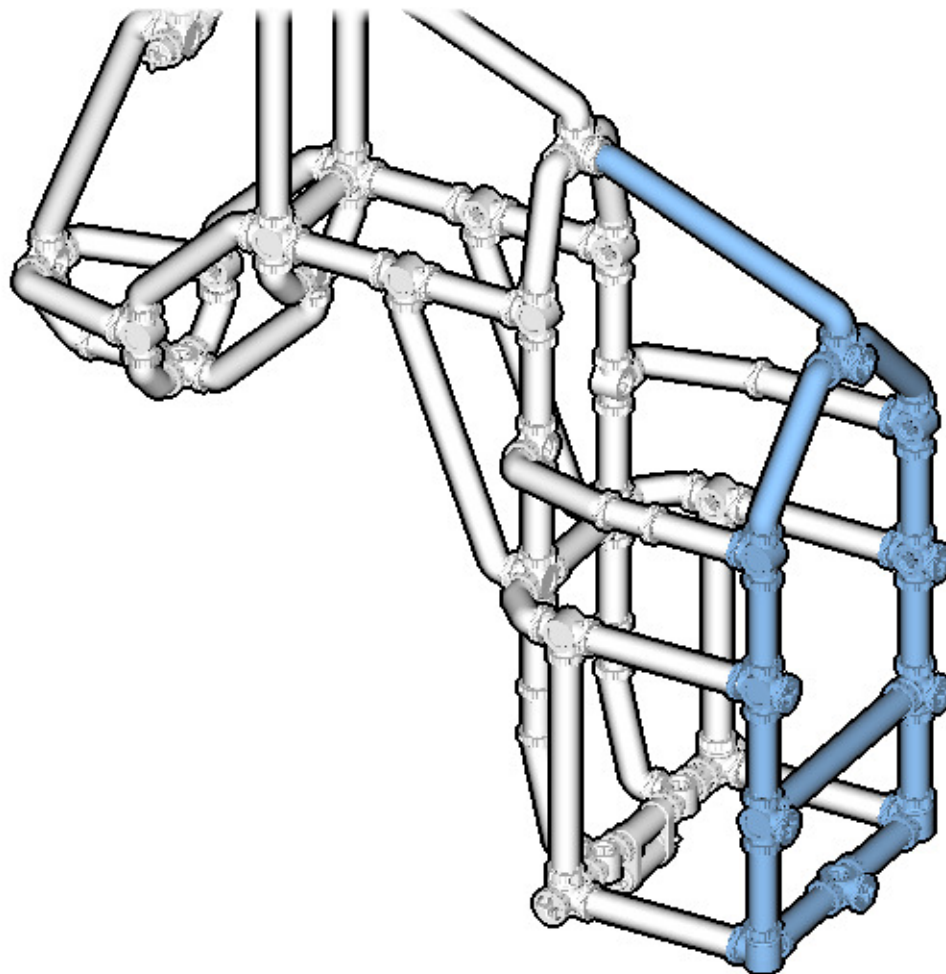

28

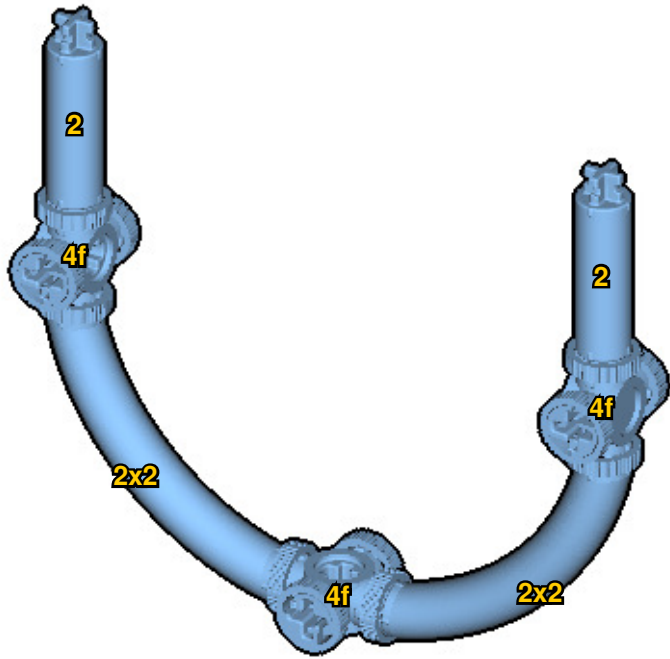

29

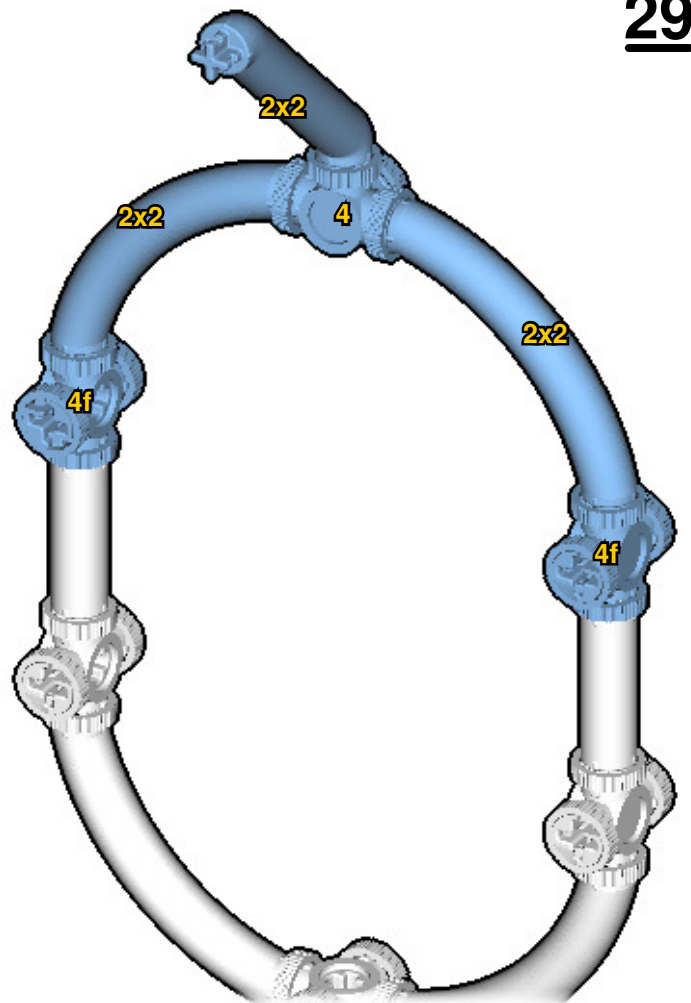

30

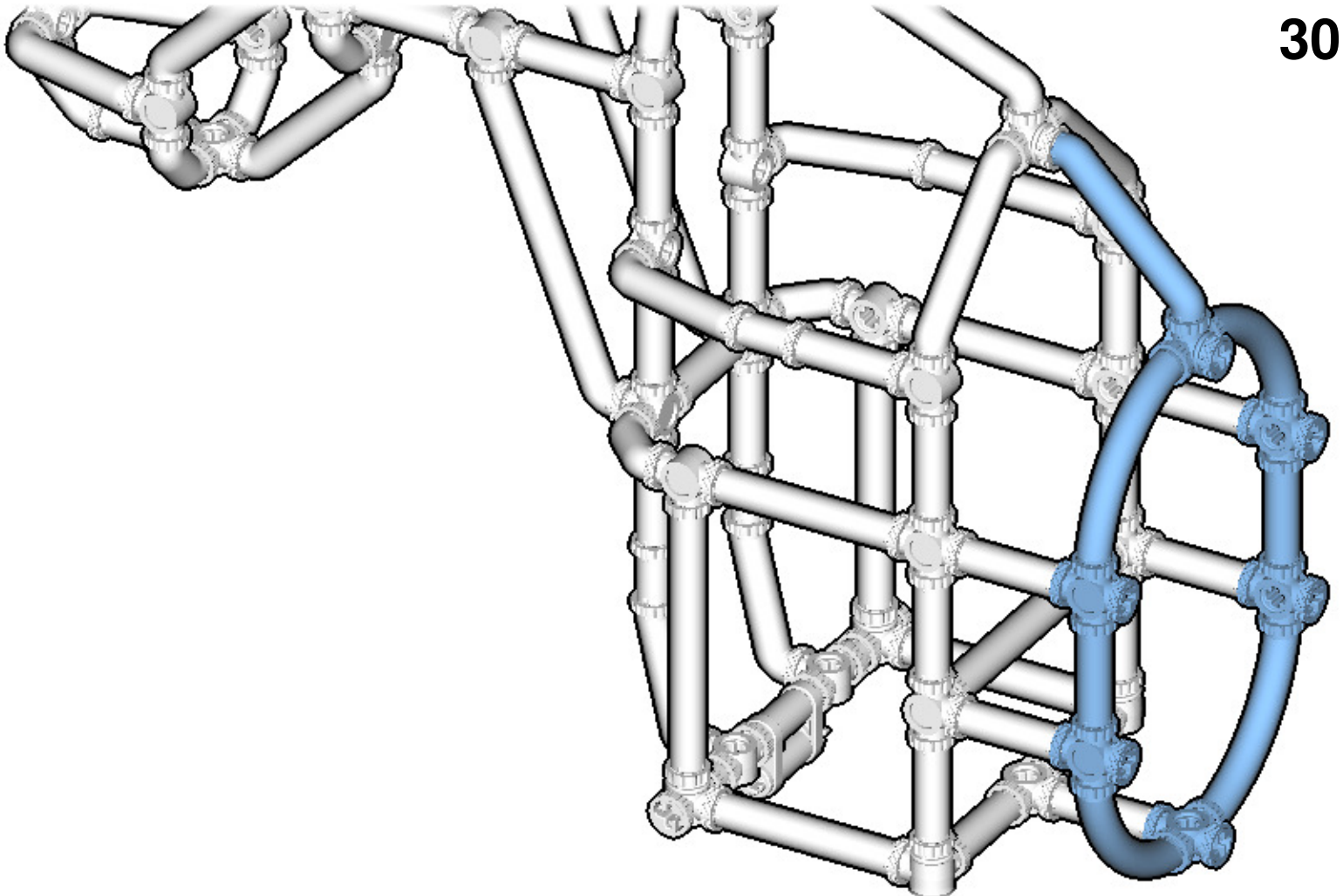

31

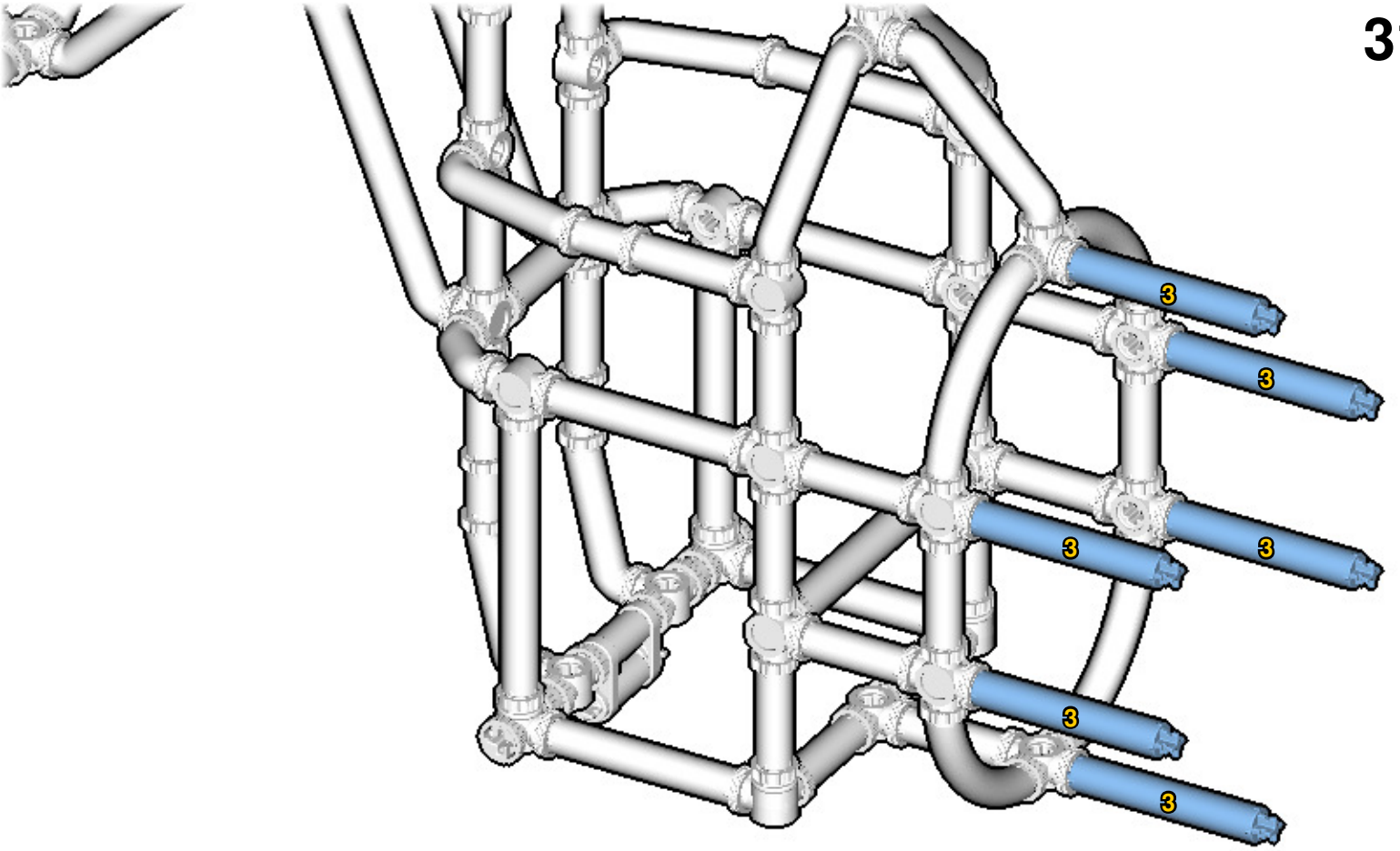

32

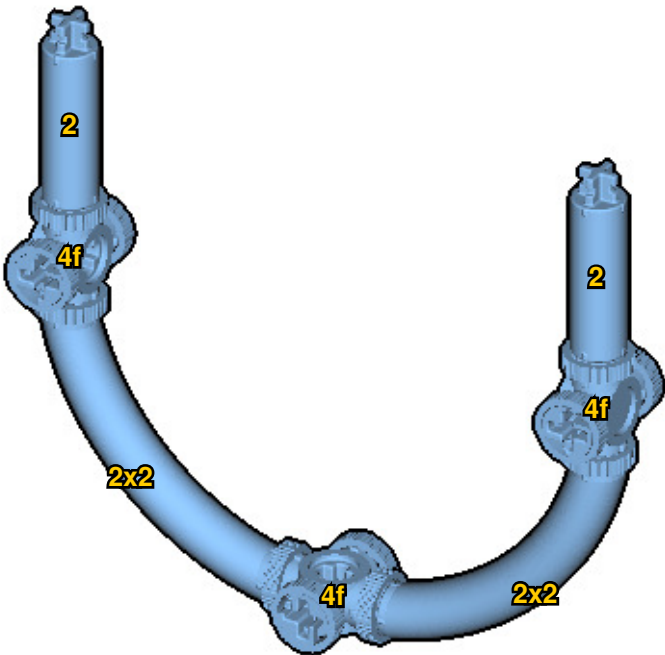

33

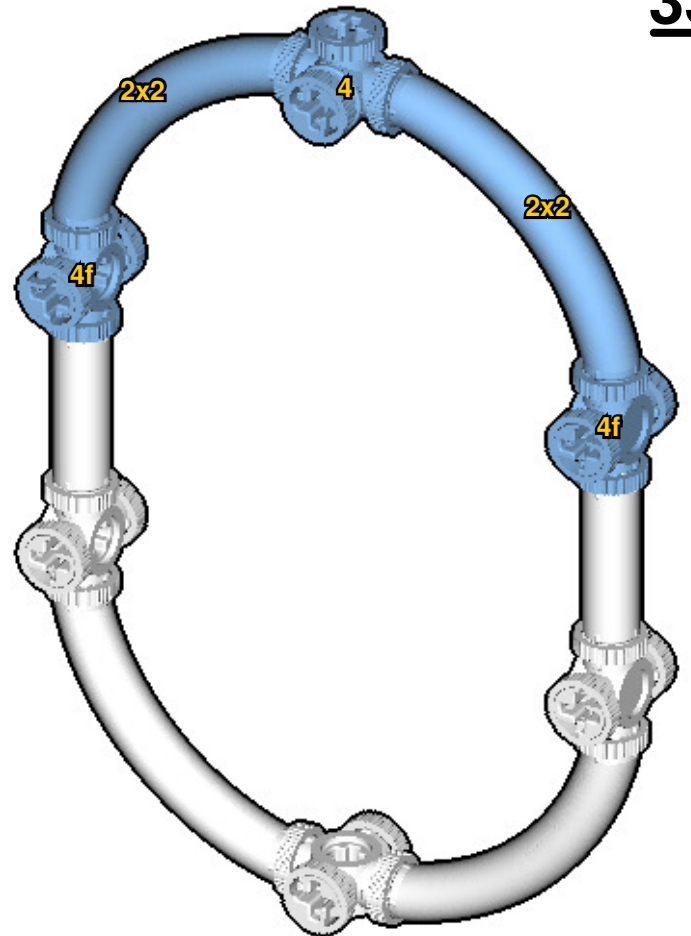

34

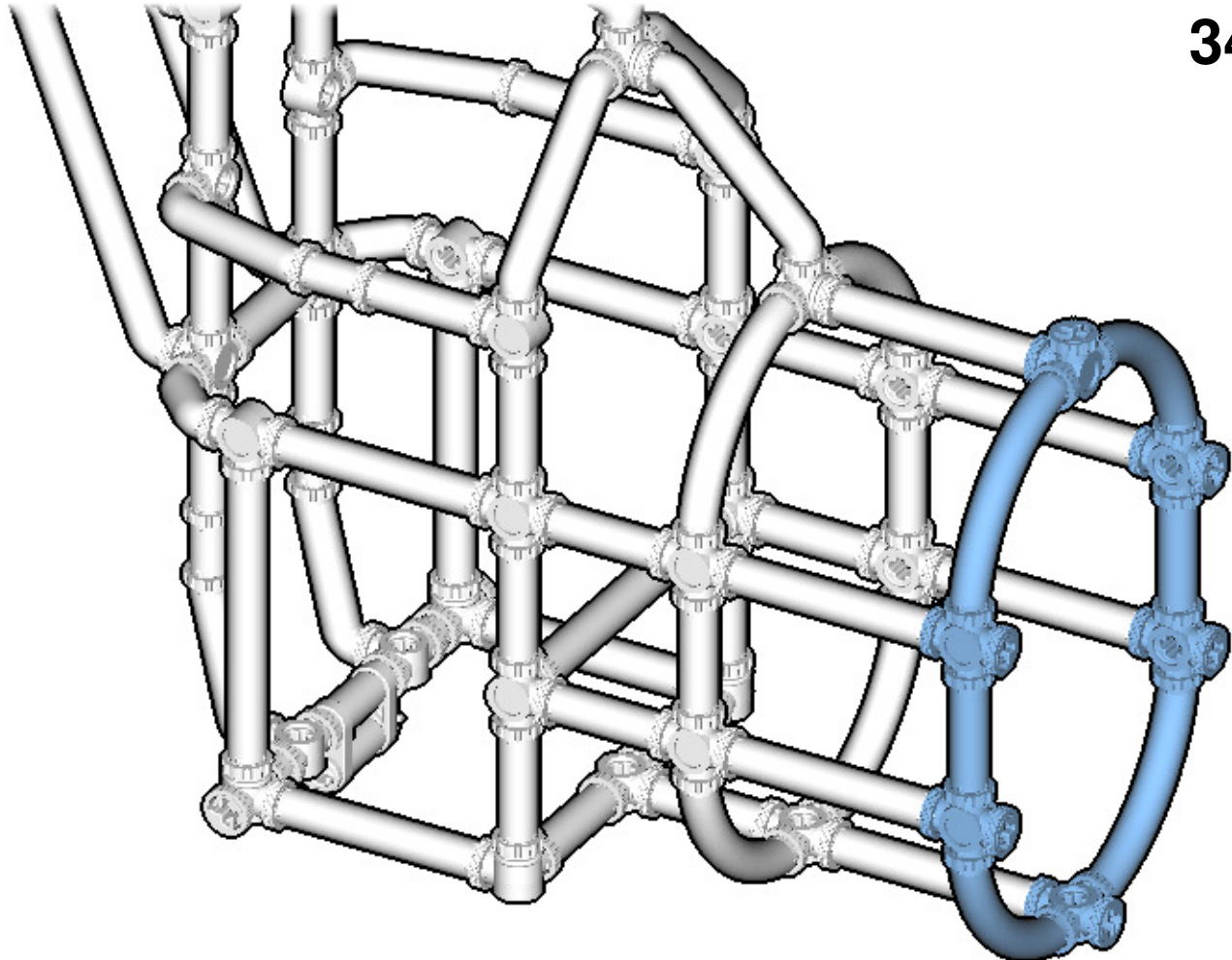

35

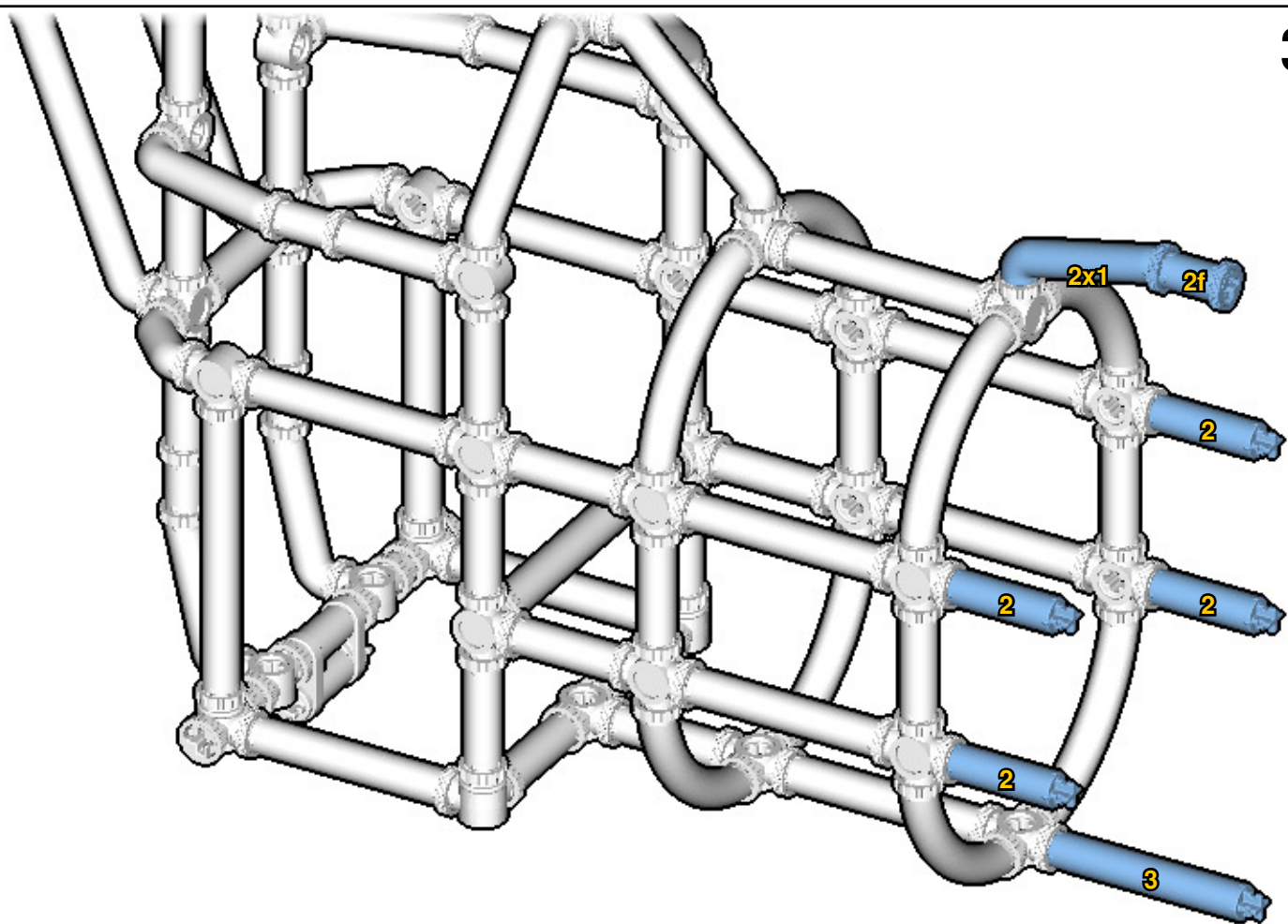

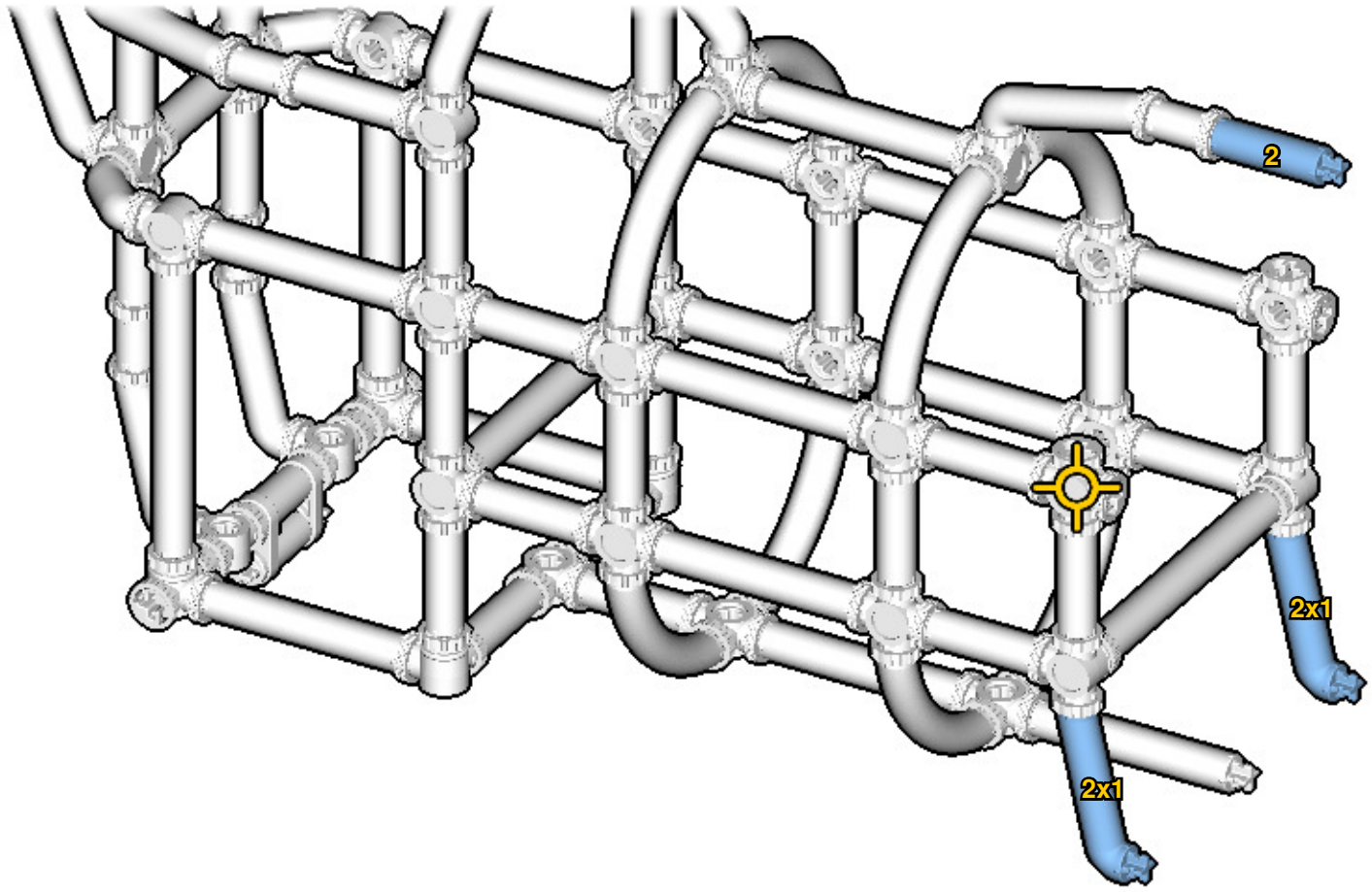
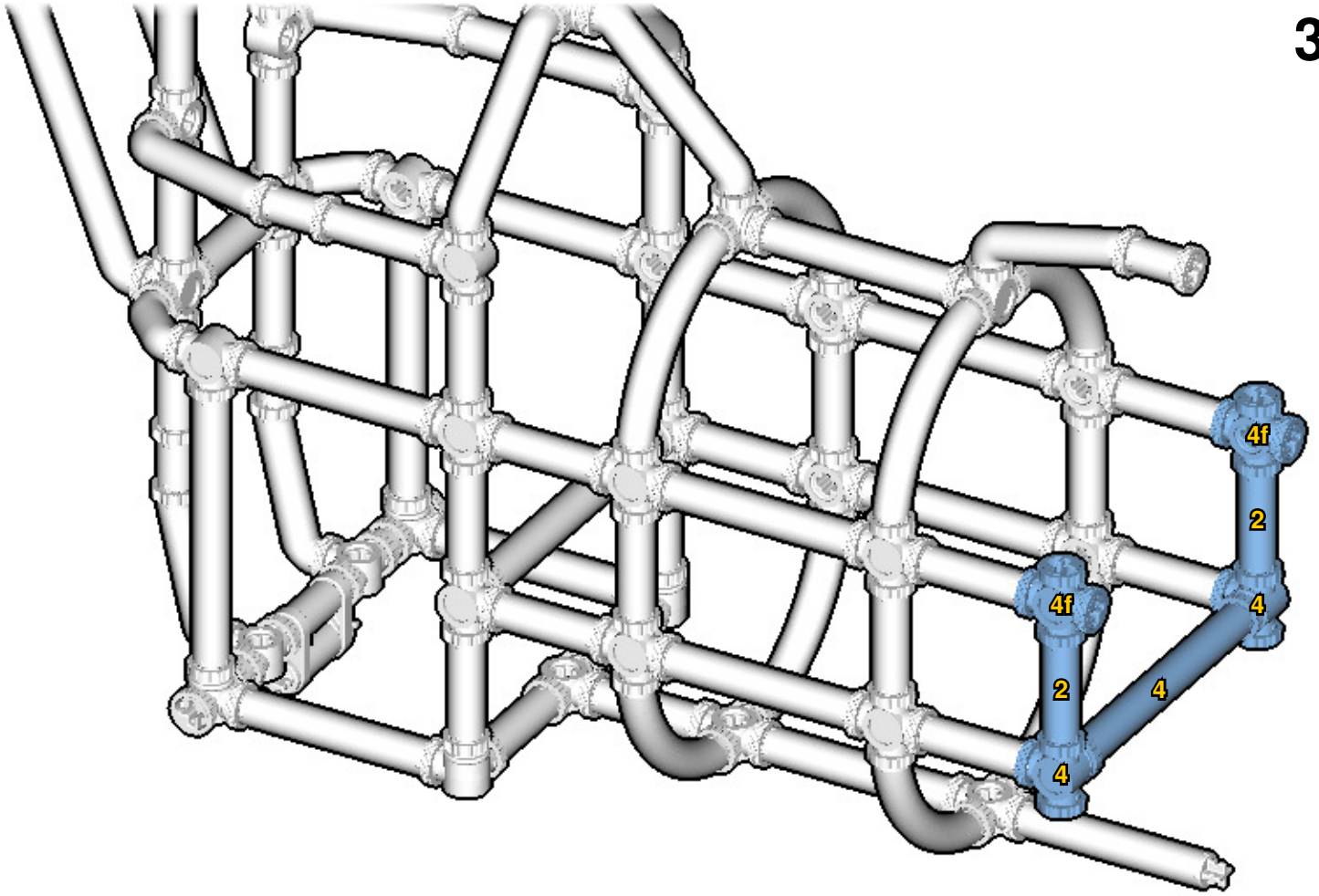

✦ : The next frame is centered on this piece.

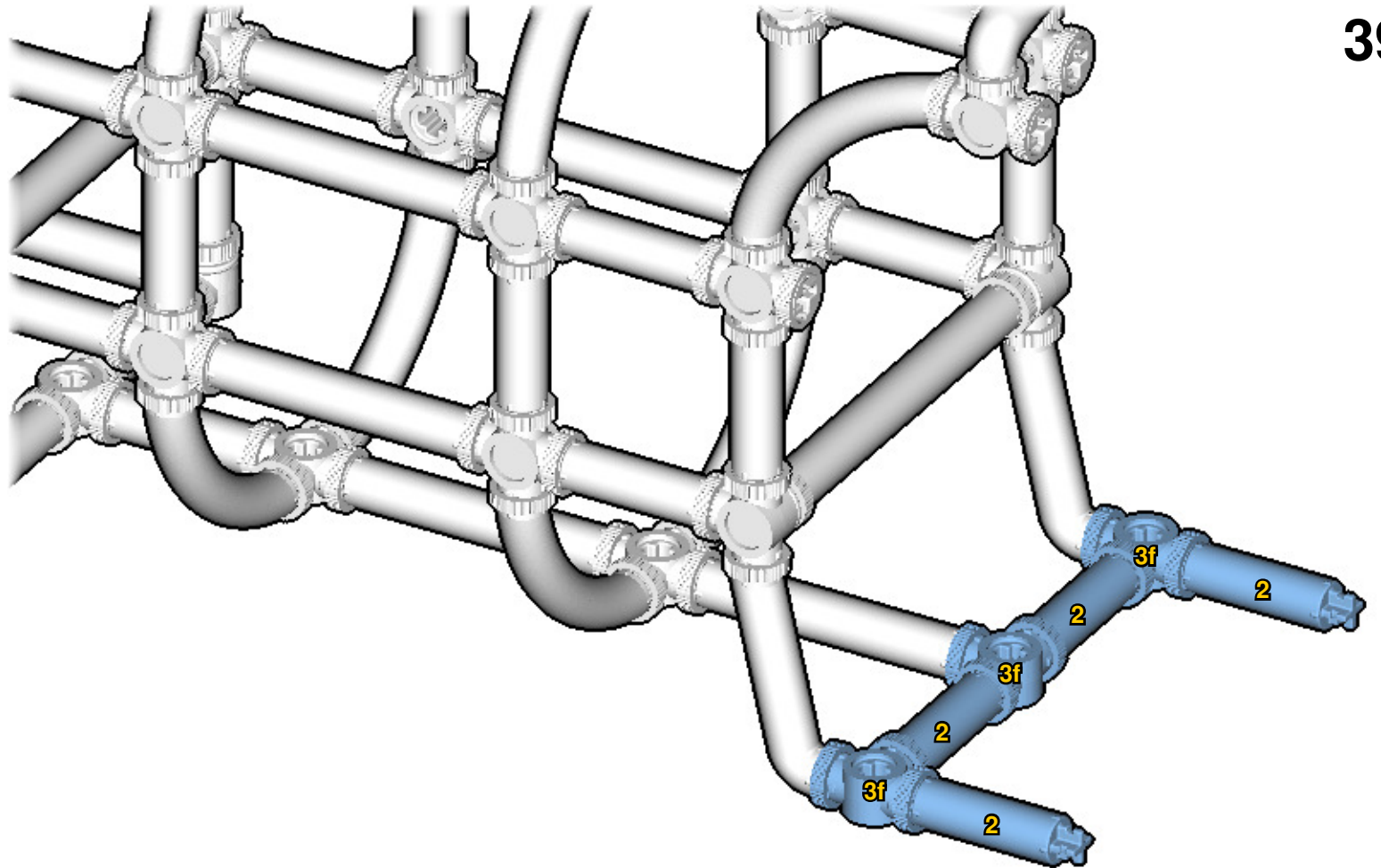
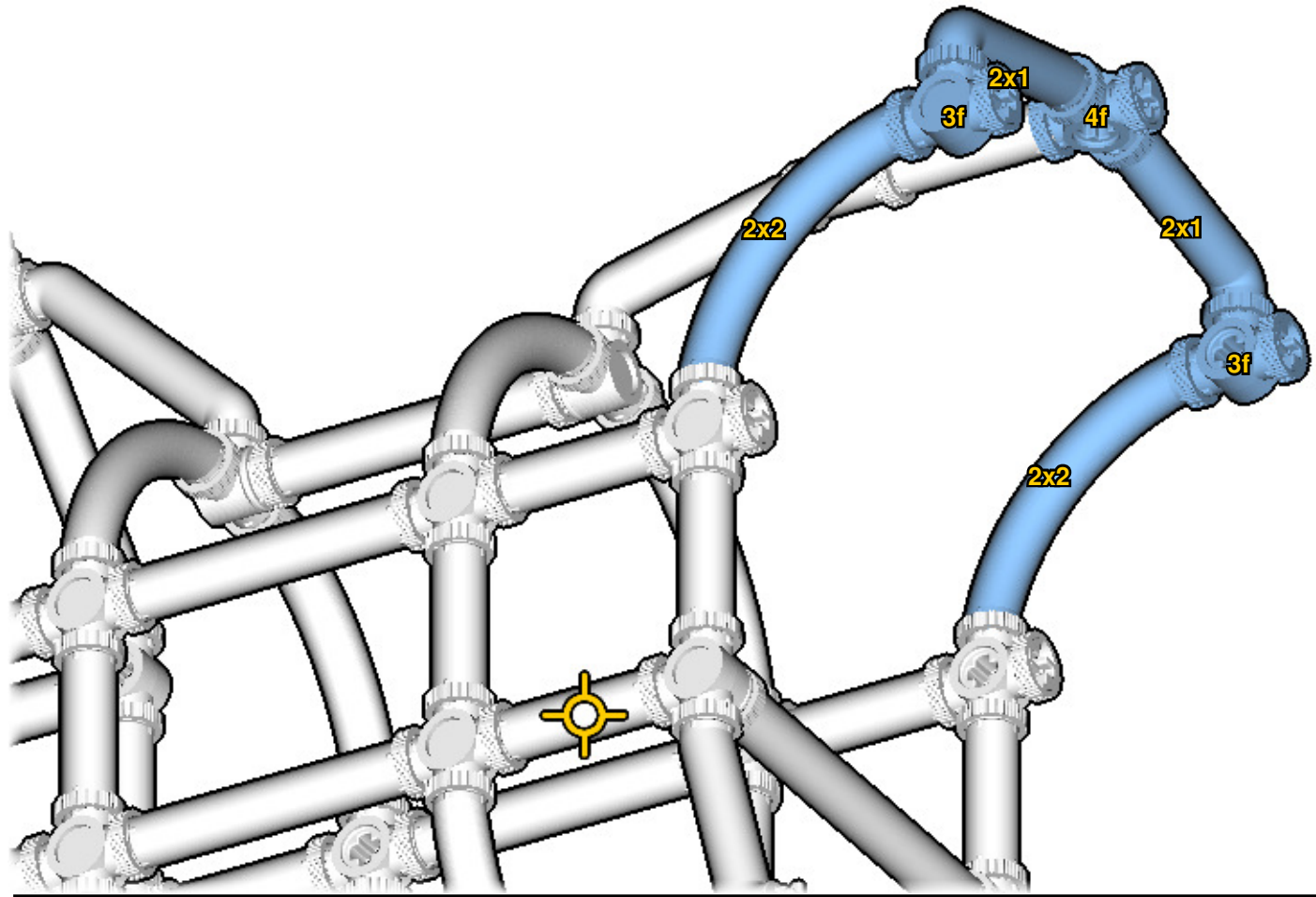

40

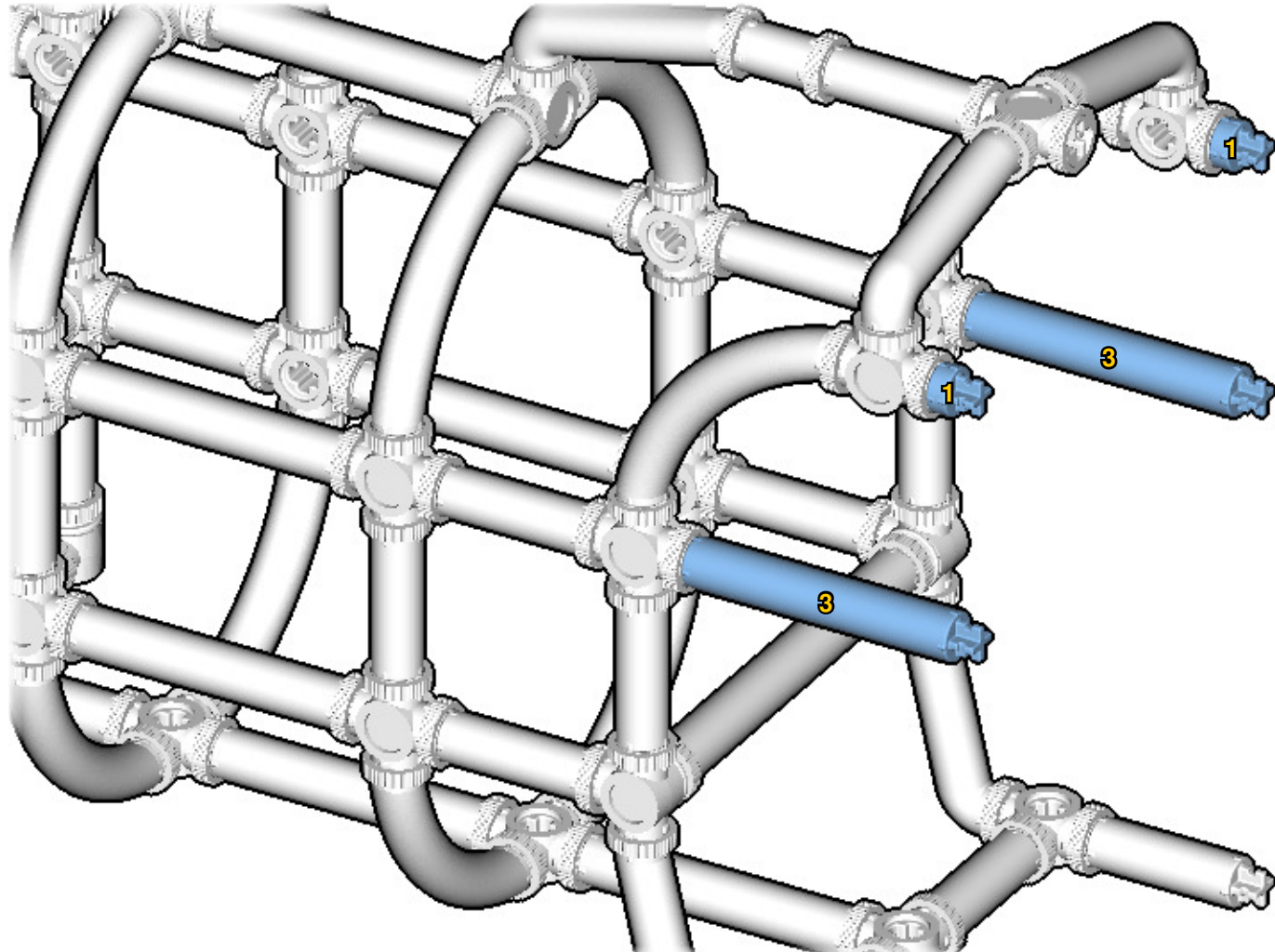

41

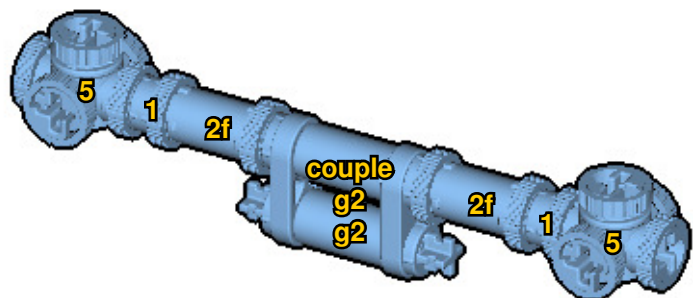

42

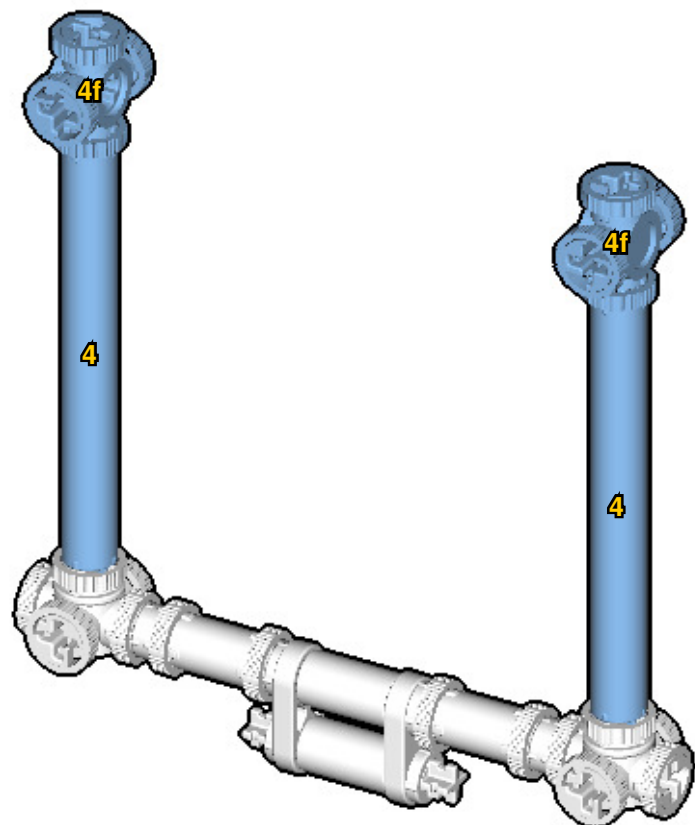

43

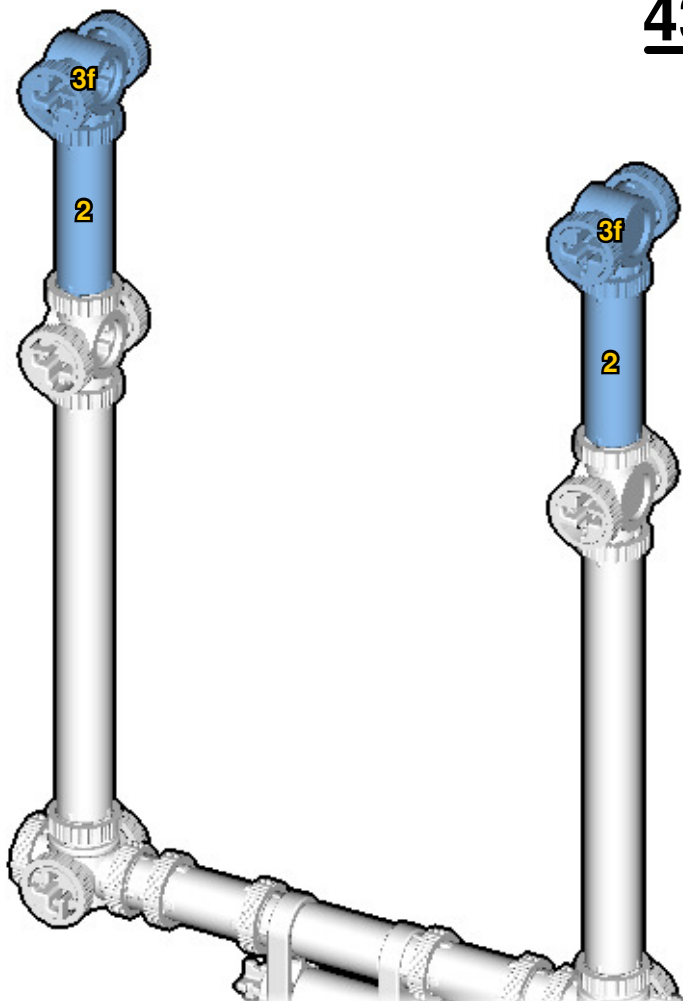

44

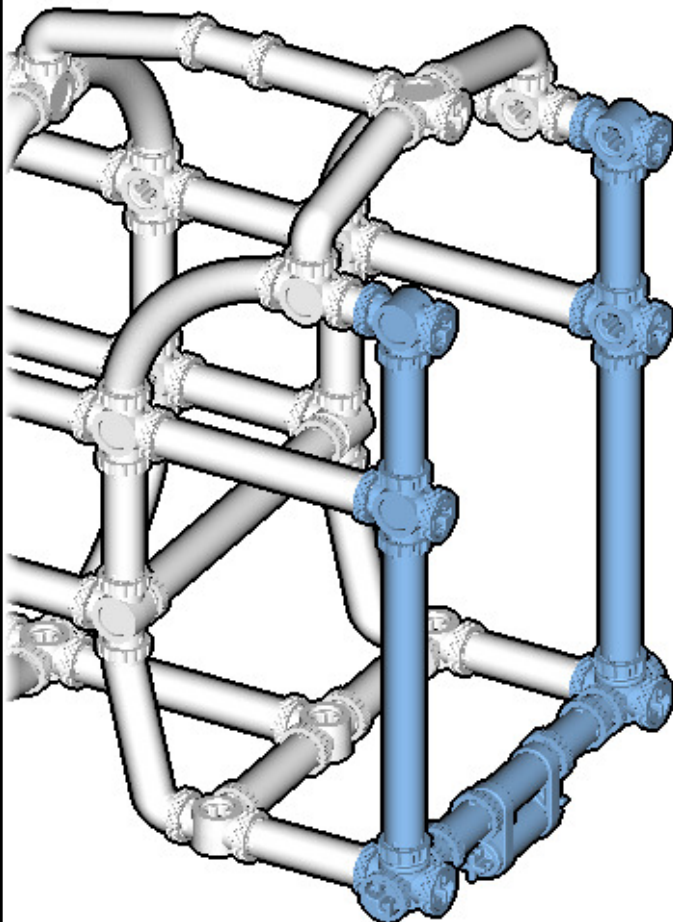

45

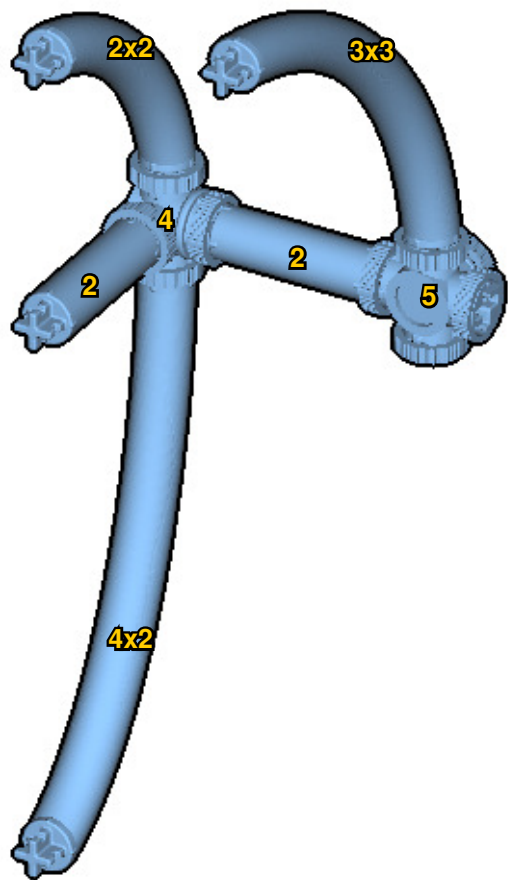

46

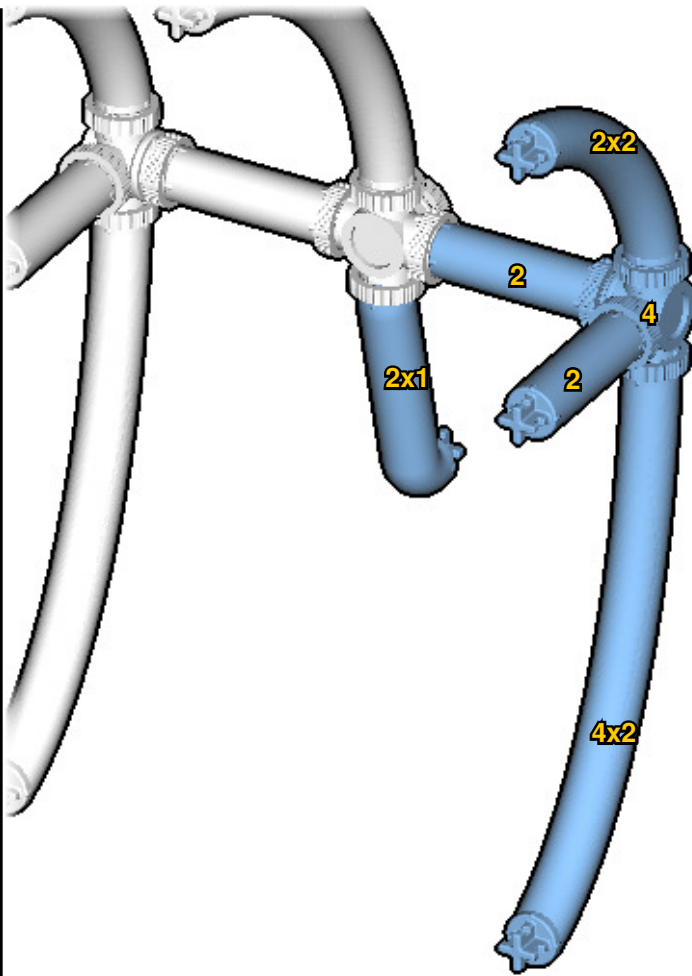

47

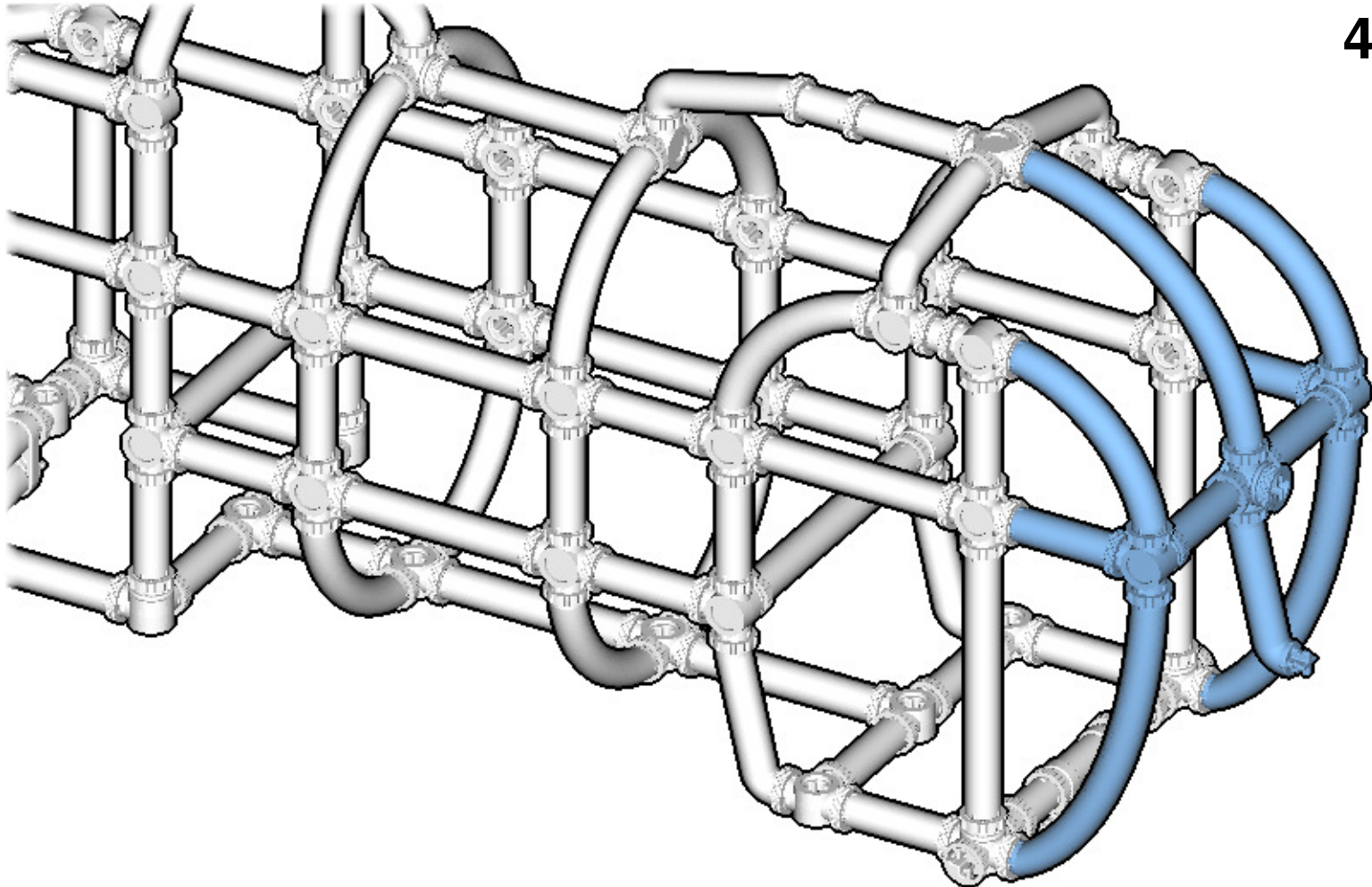

48

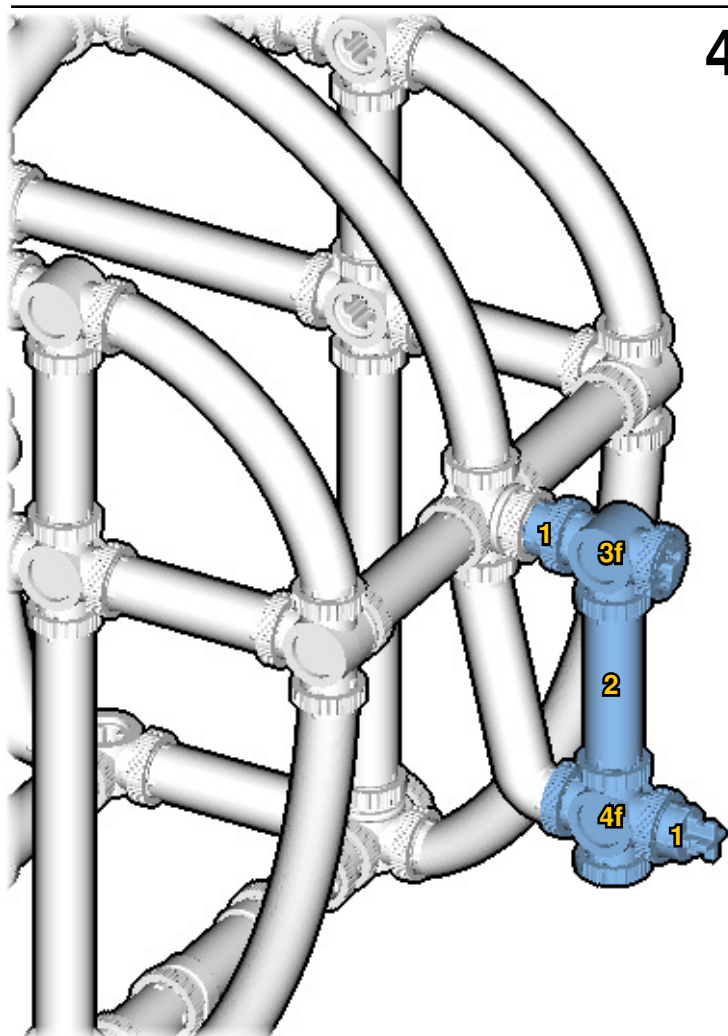

49

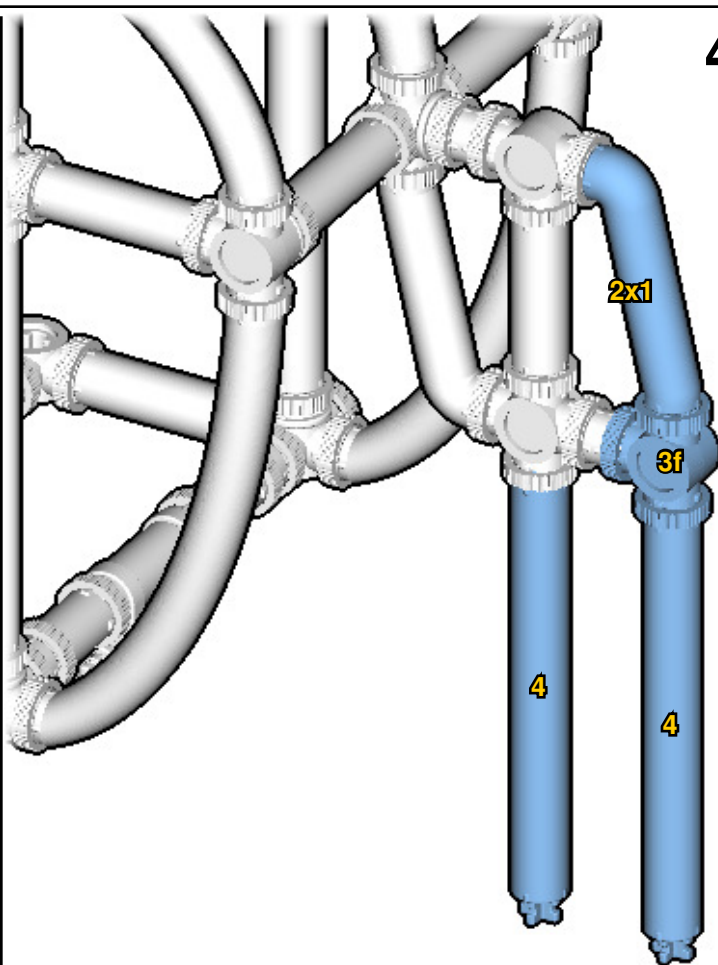

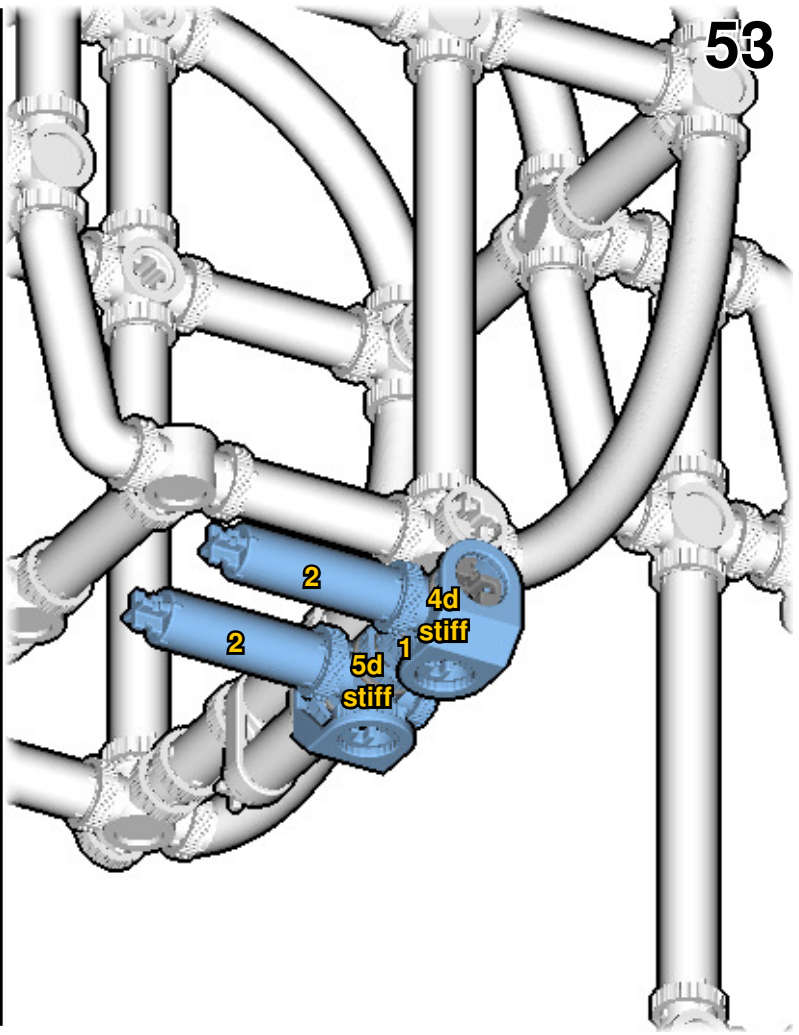
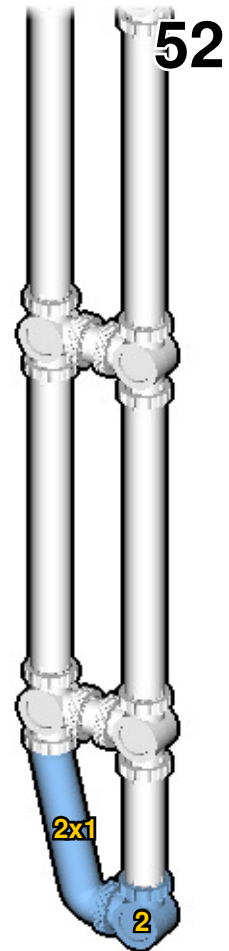
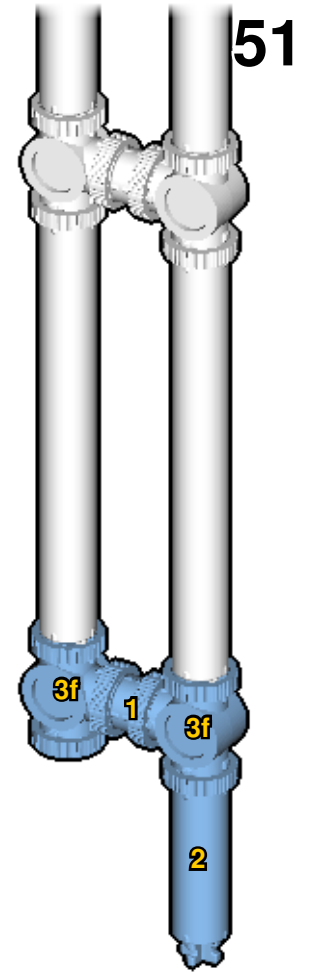
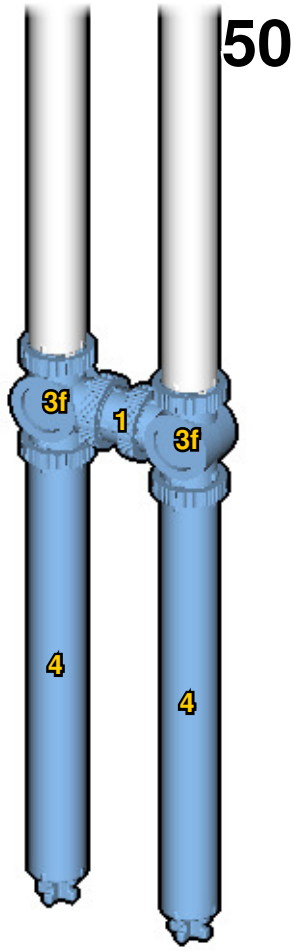

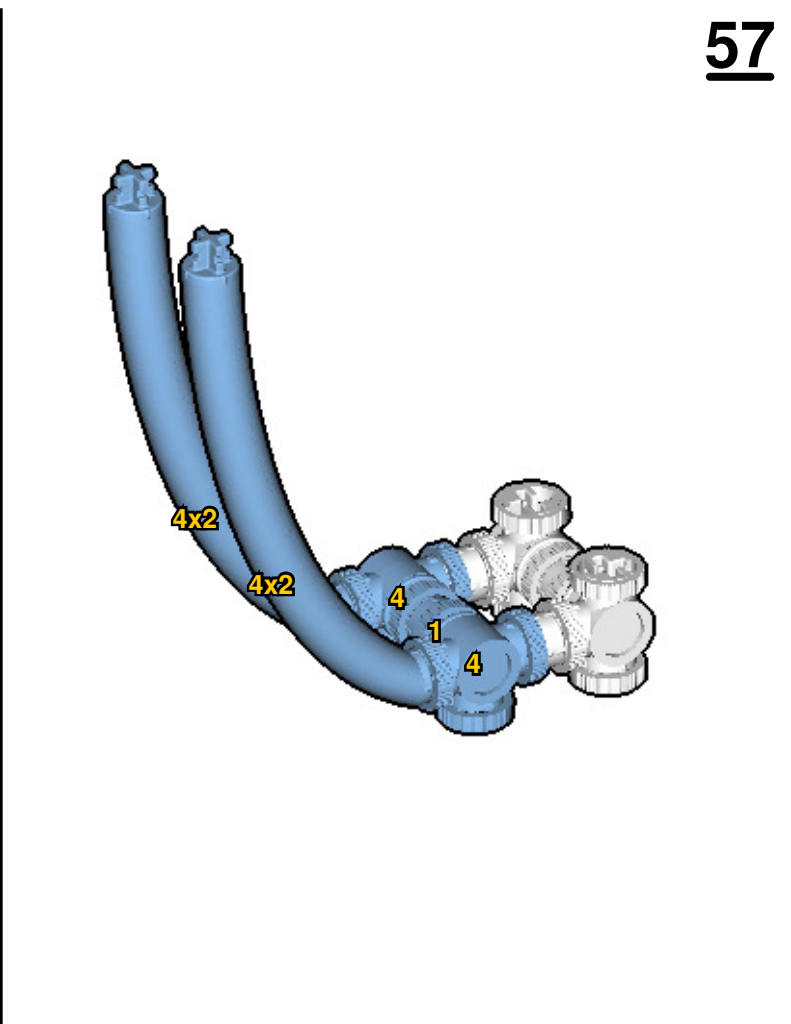
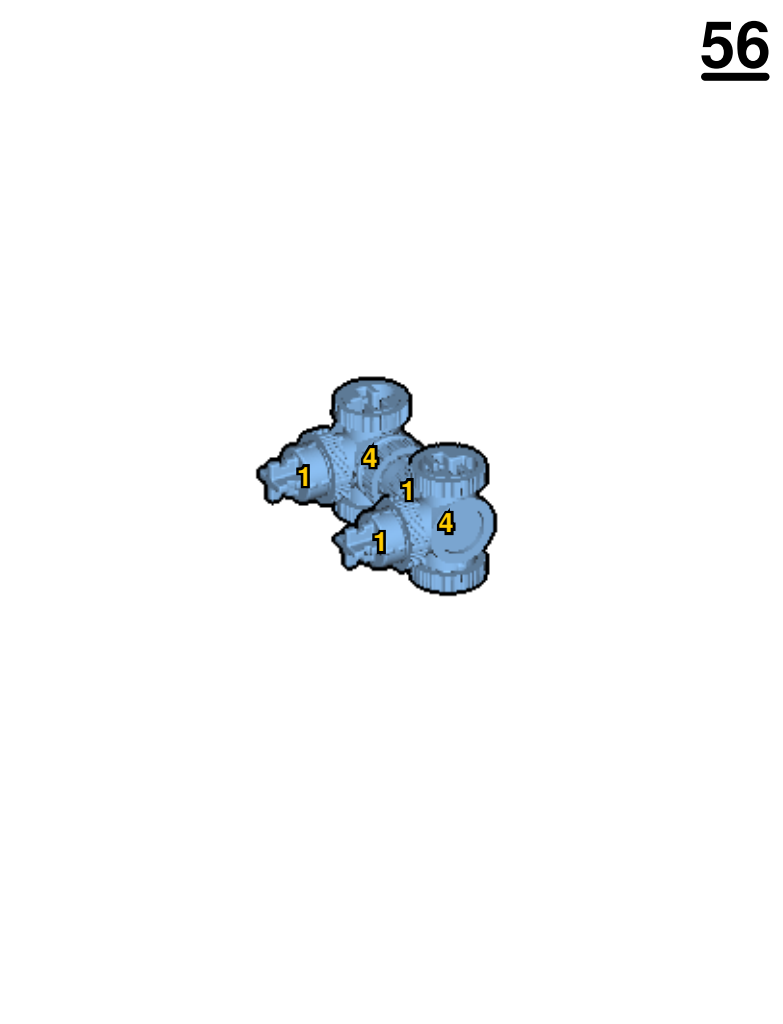
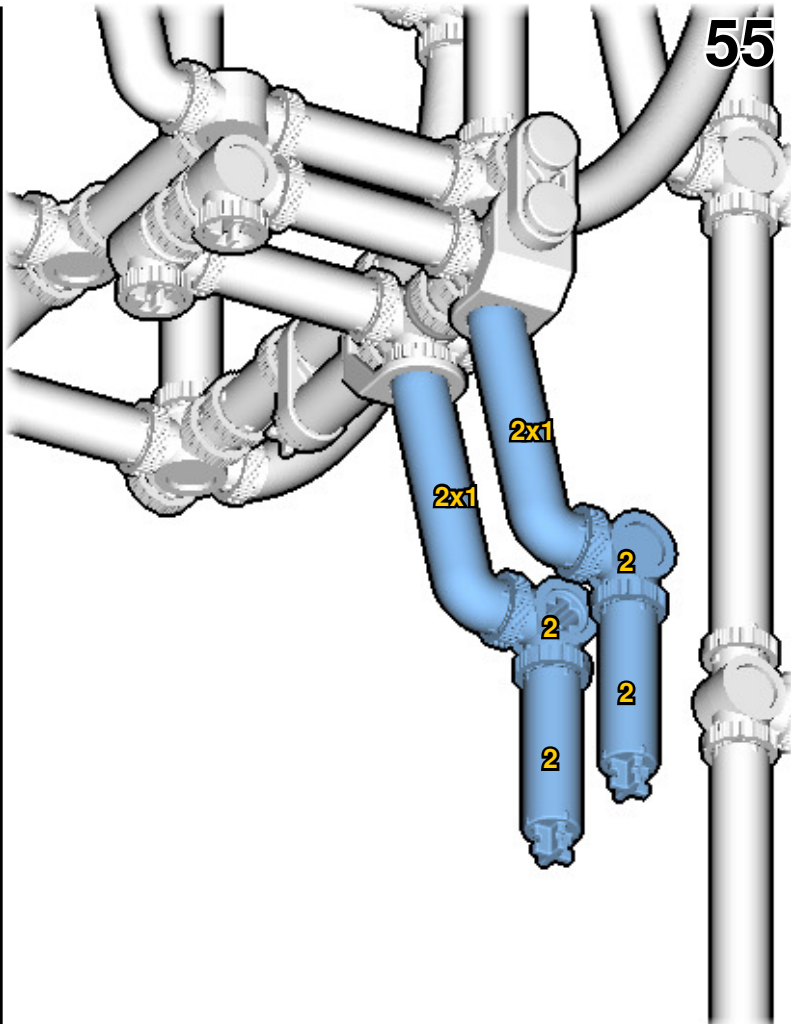
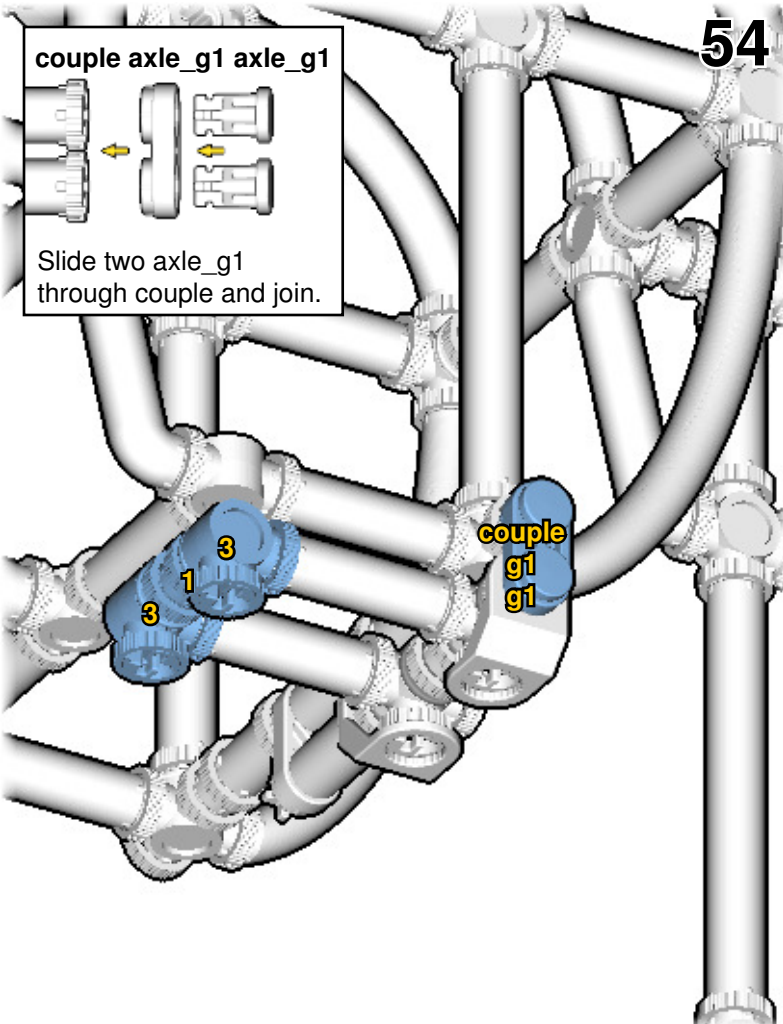

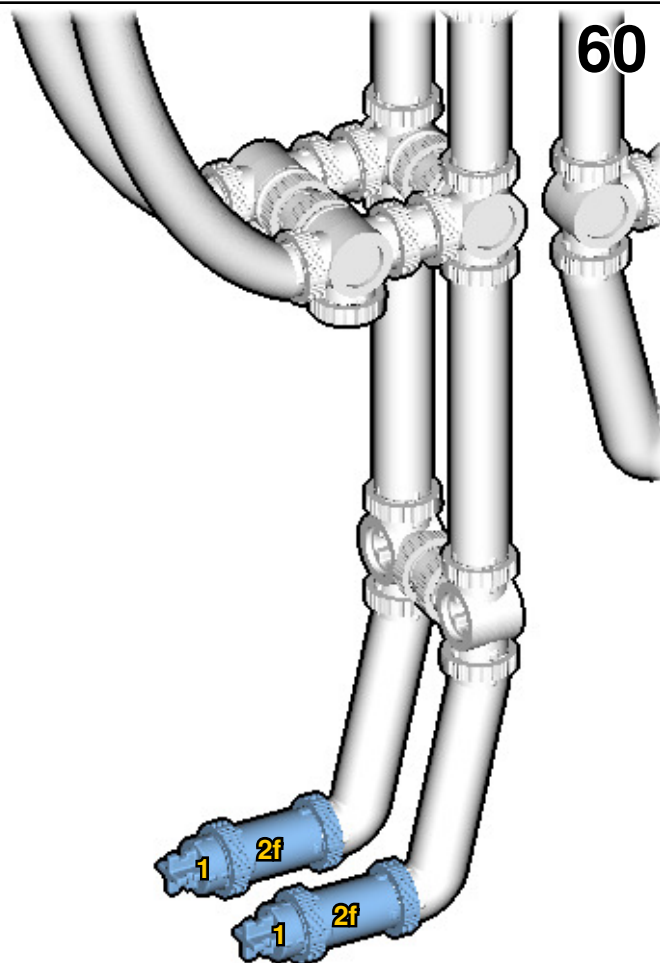
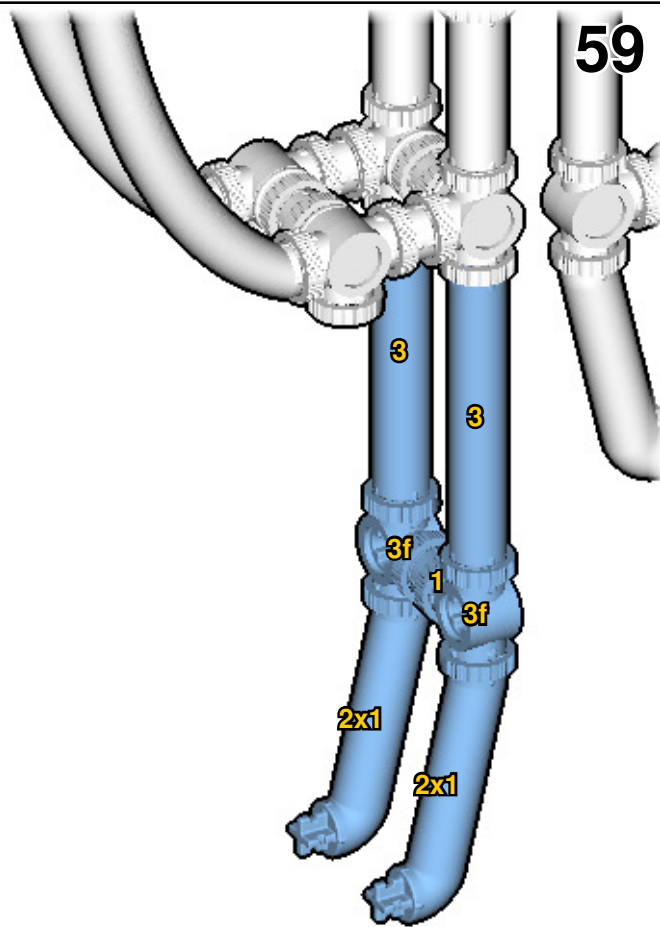
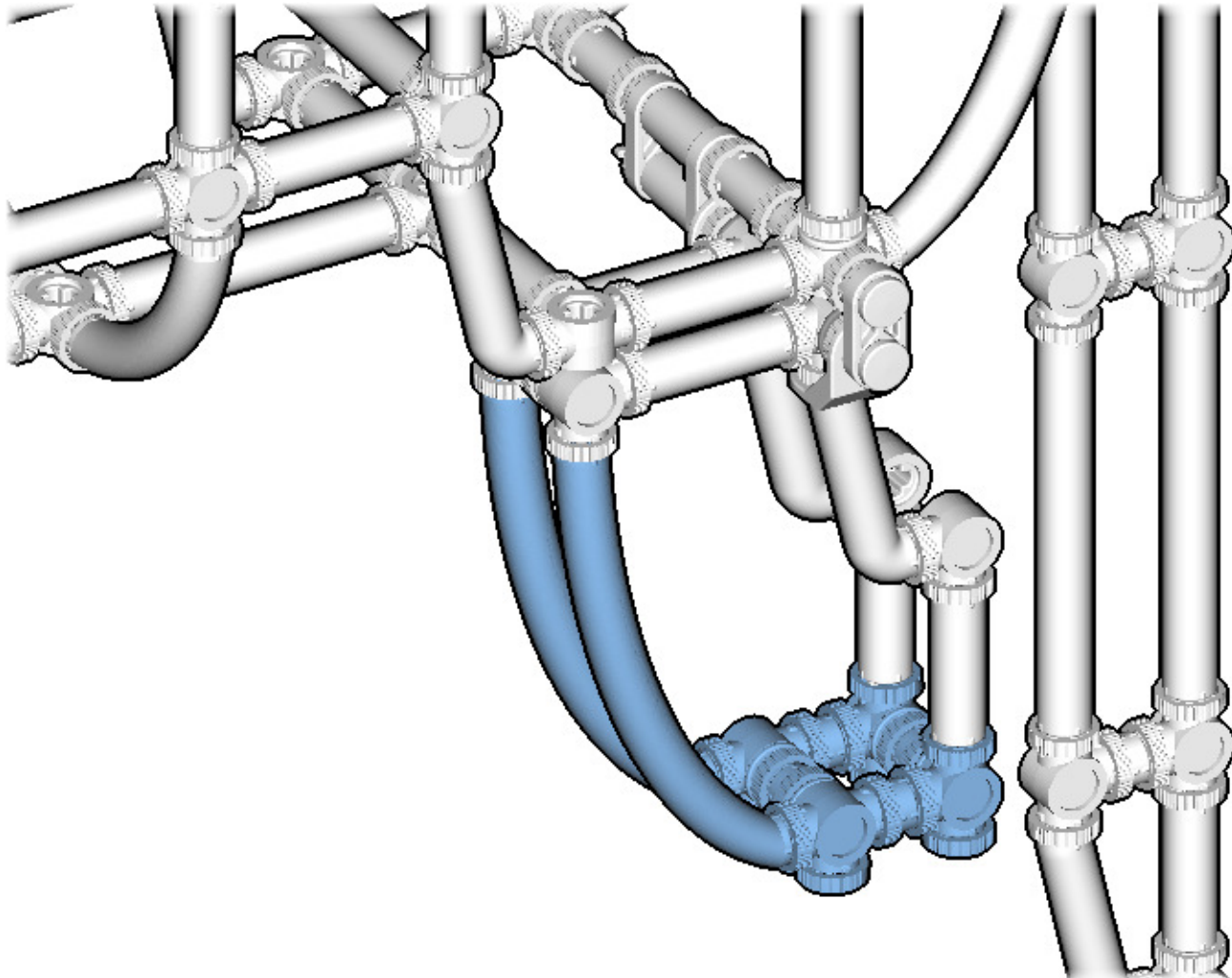

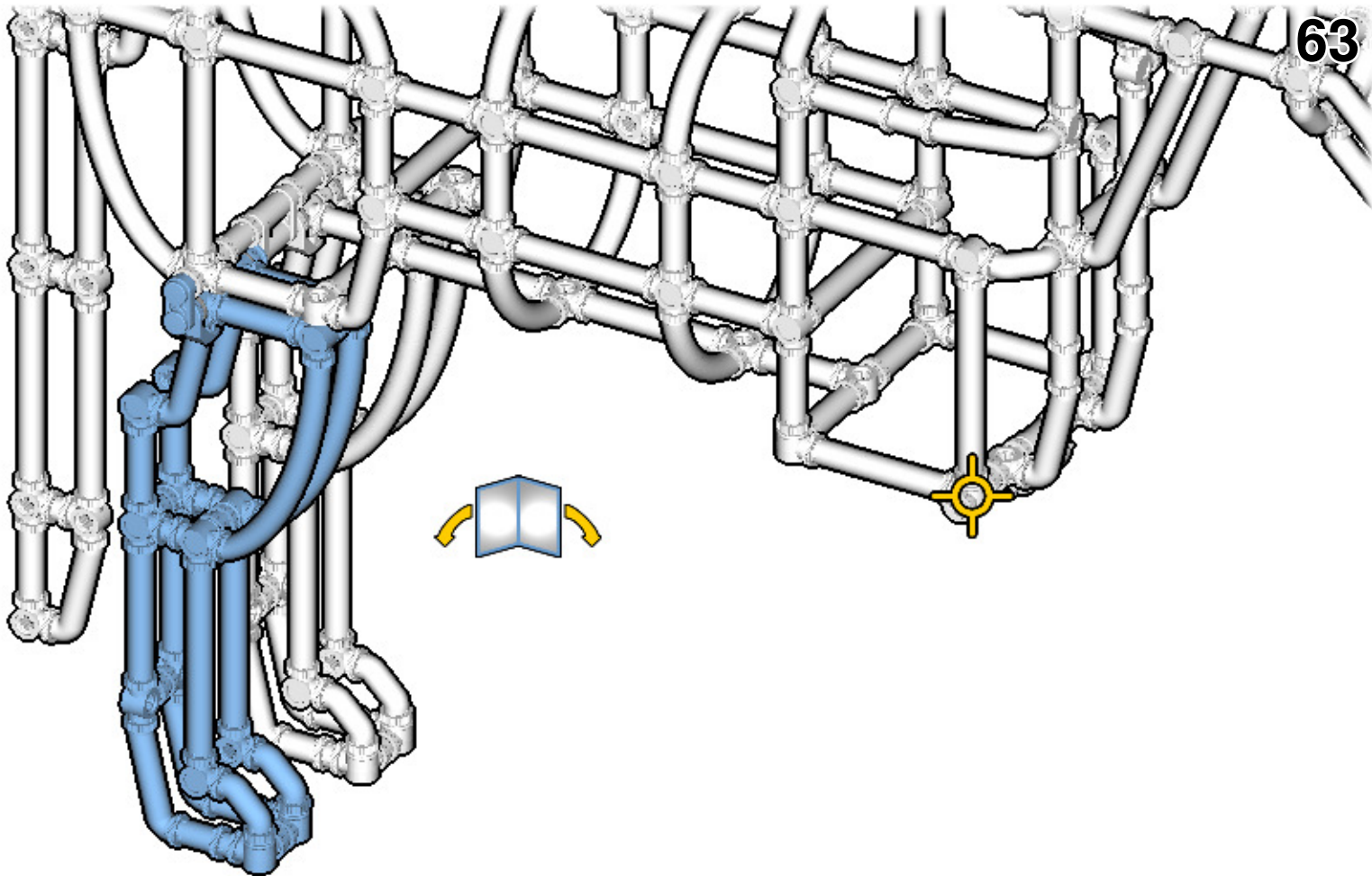
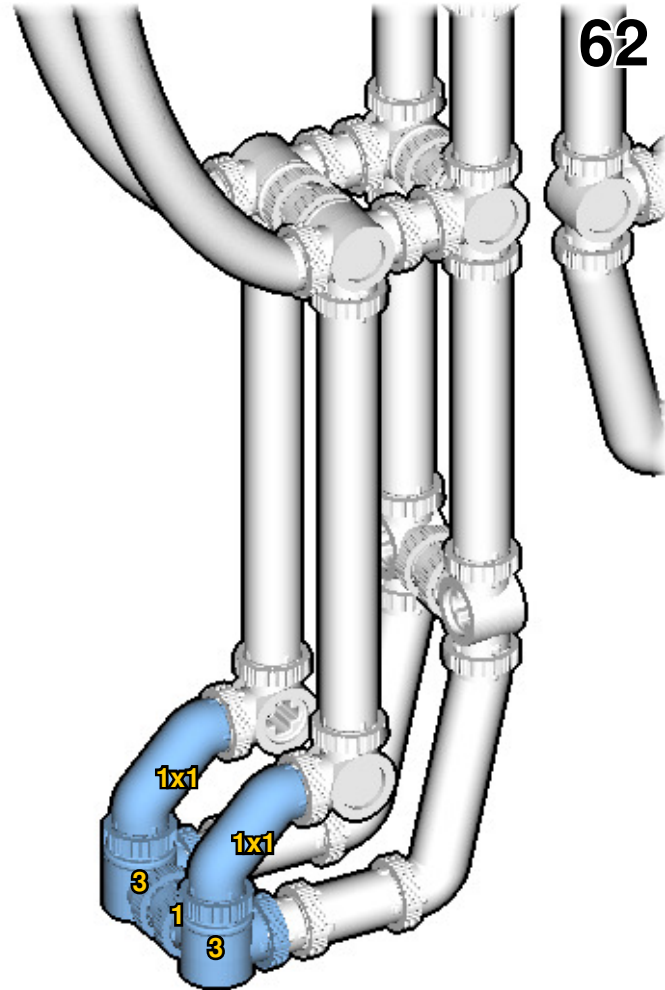
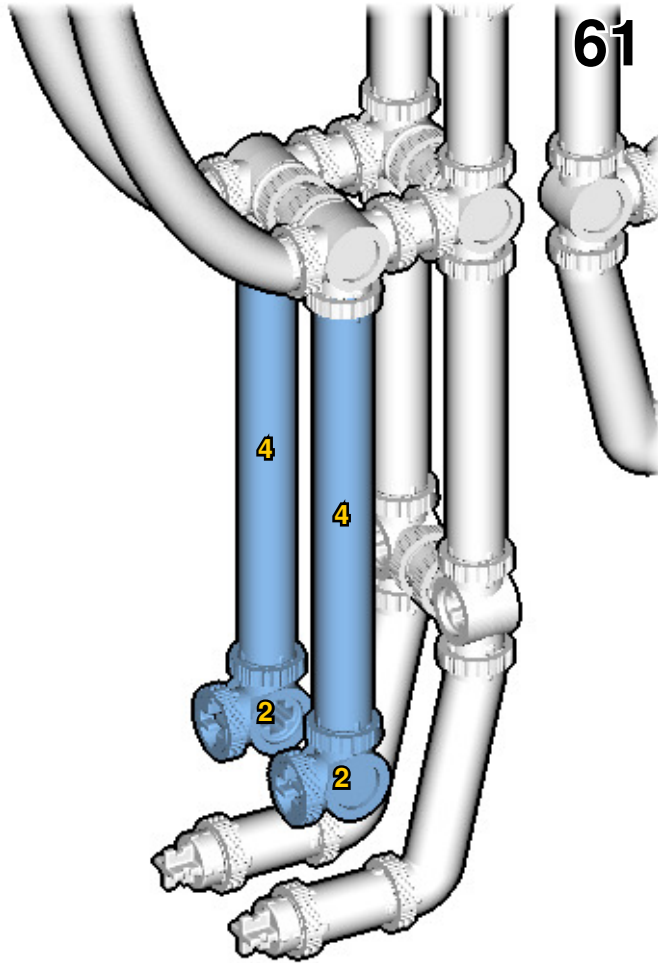

 : Copy new pieces from old pieces.

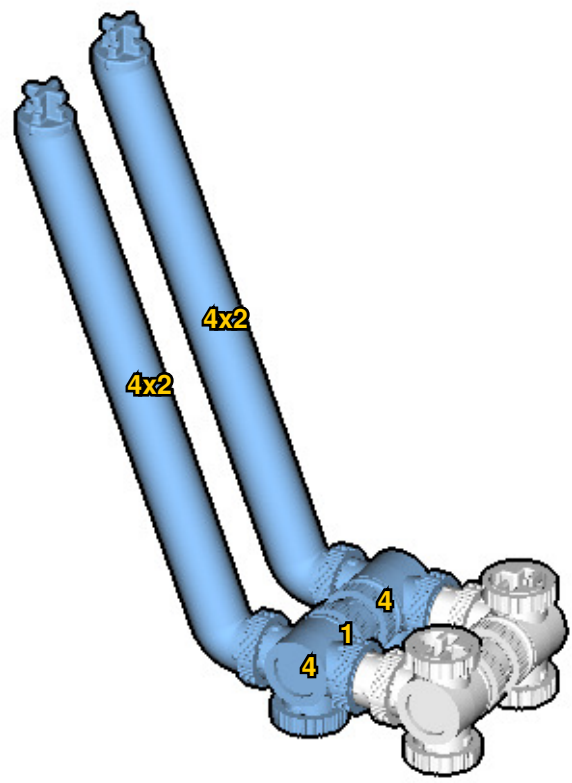
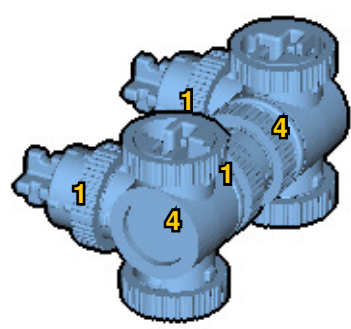
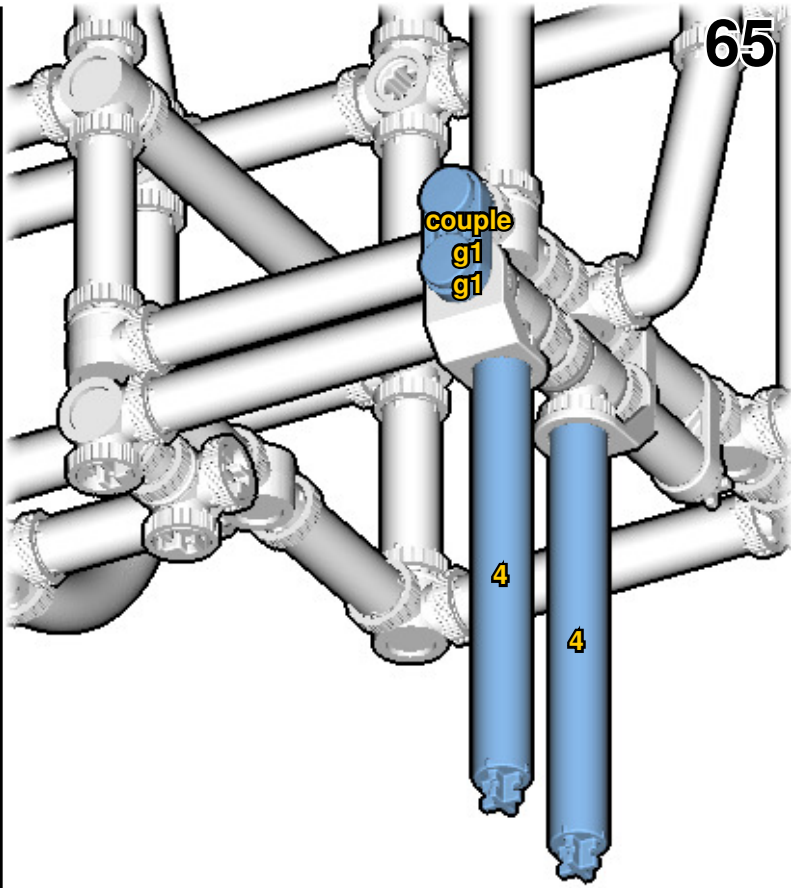
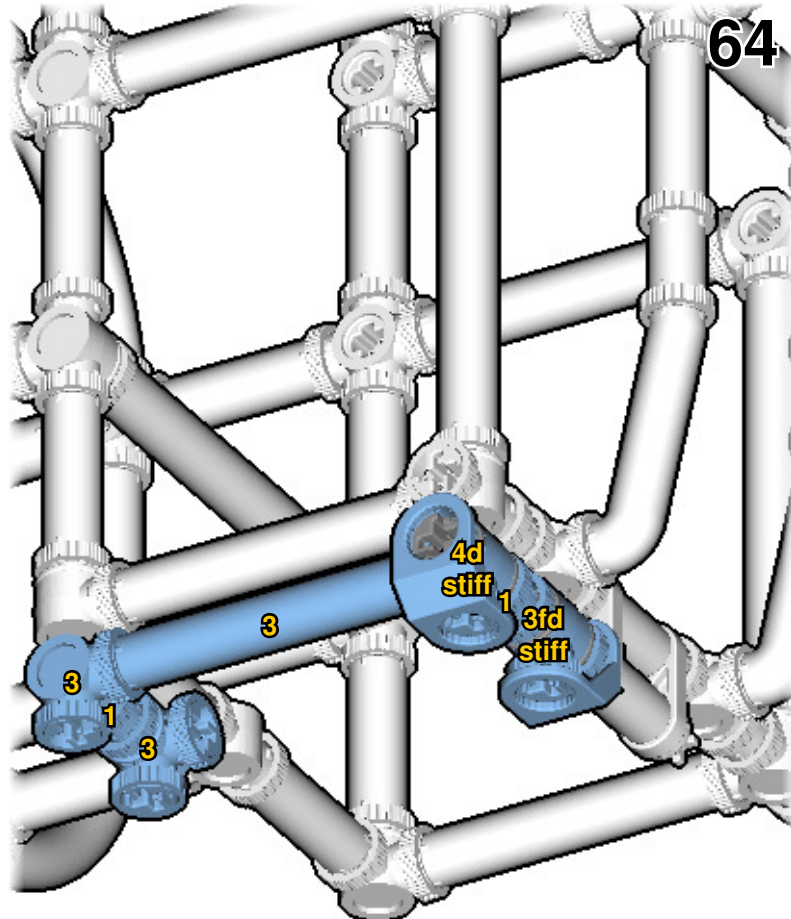

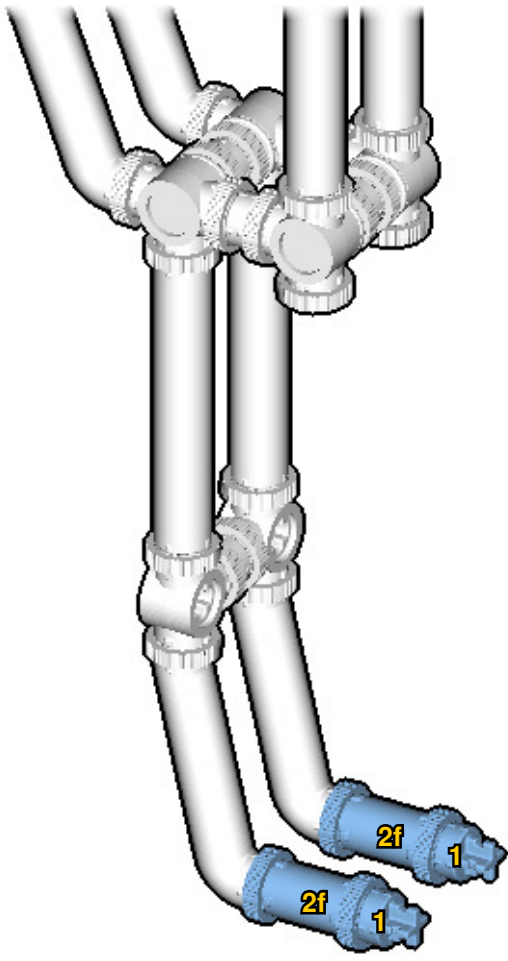
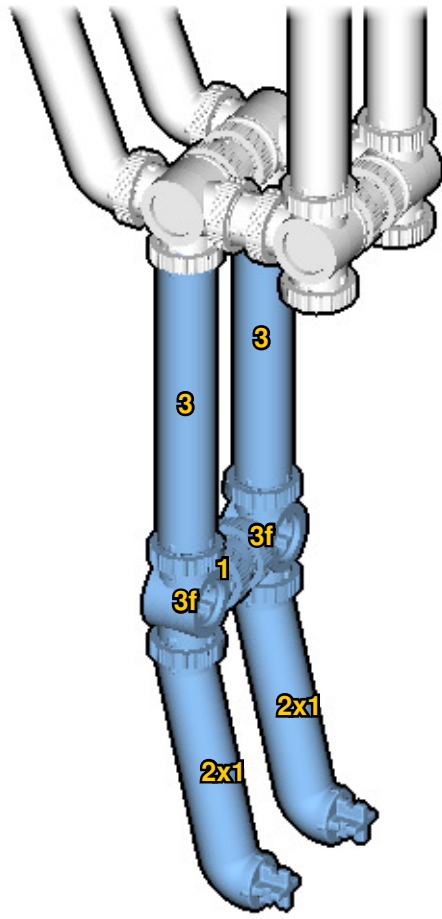
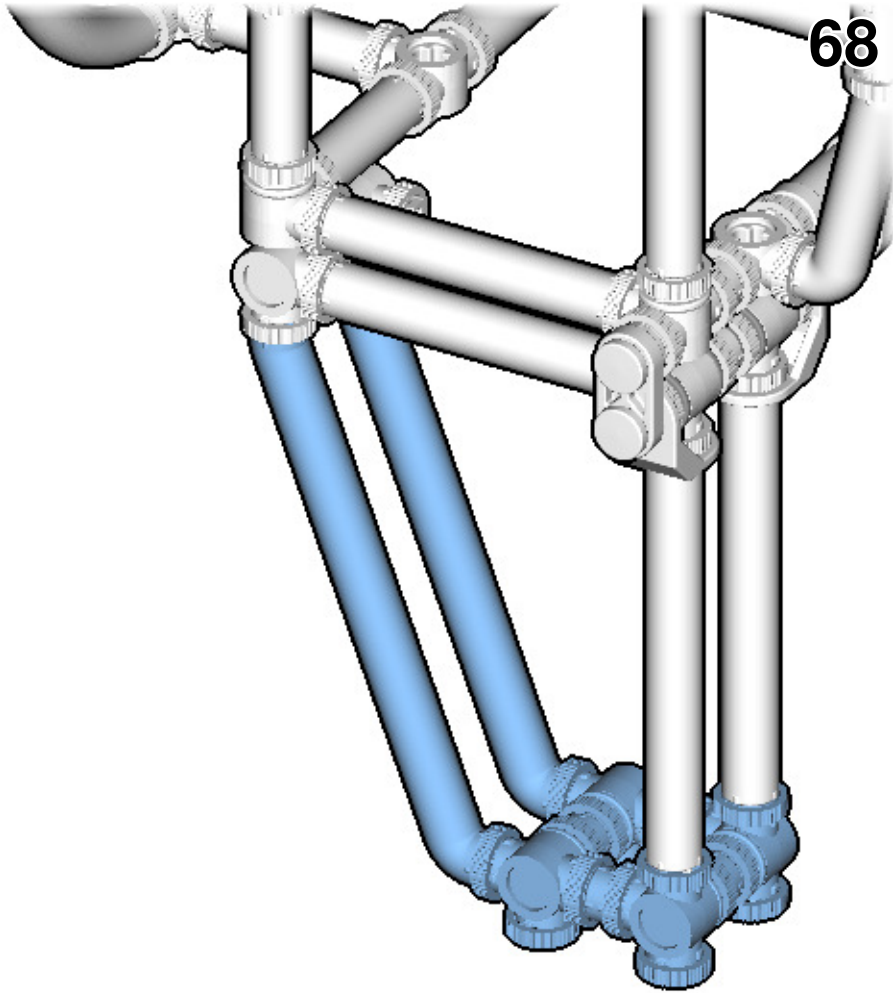

71

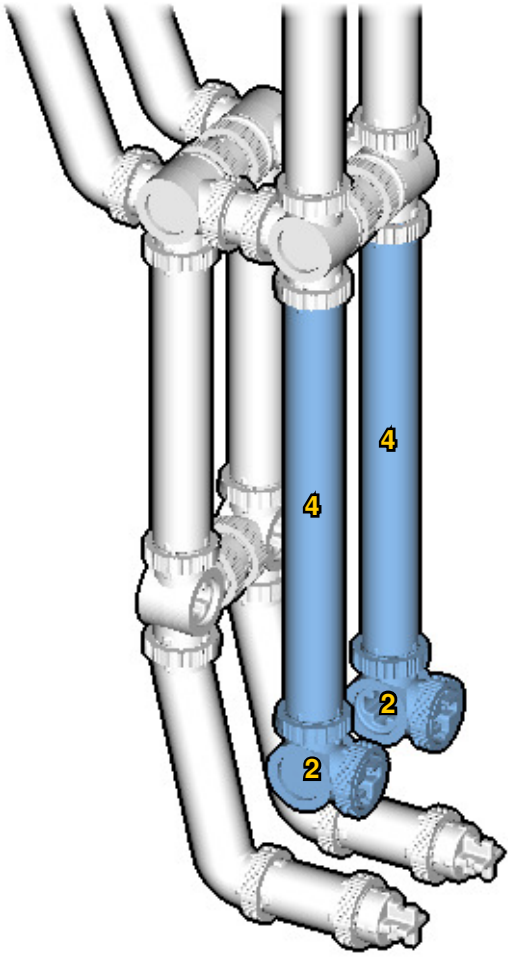

72

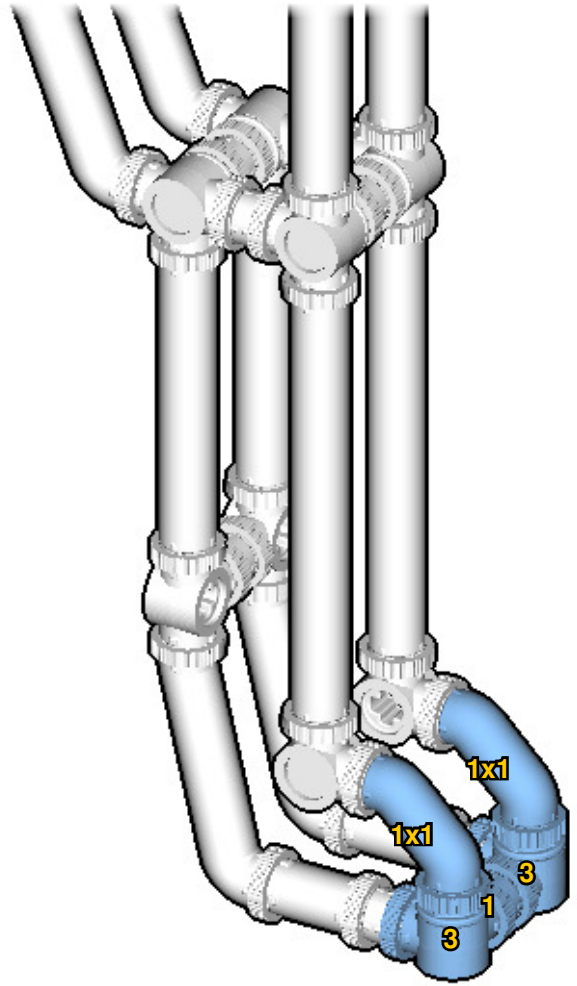

73

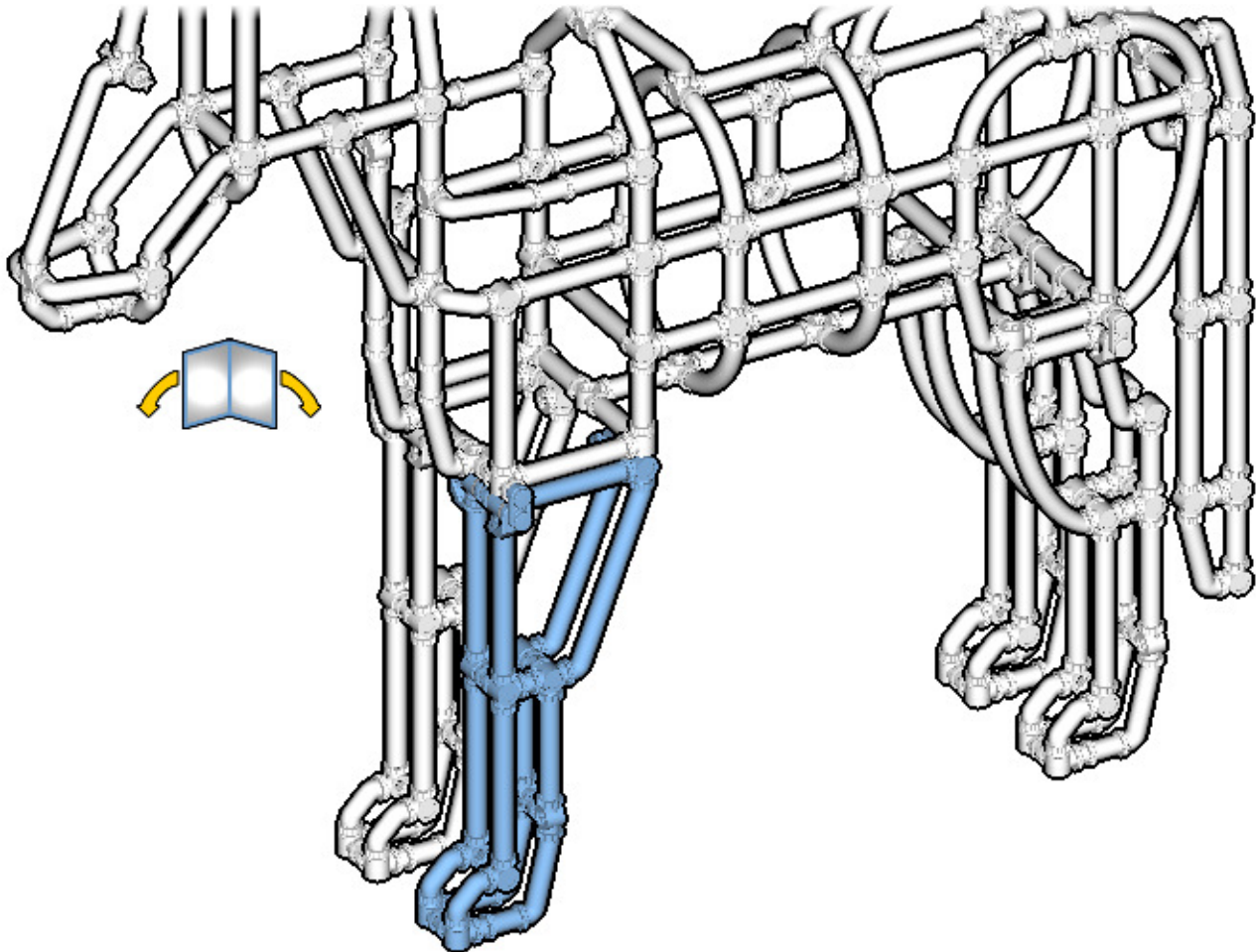

INVENTORY

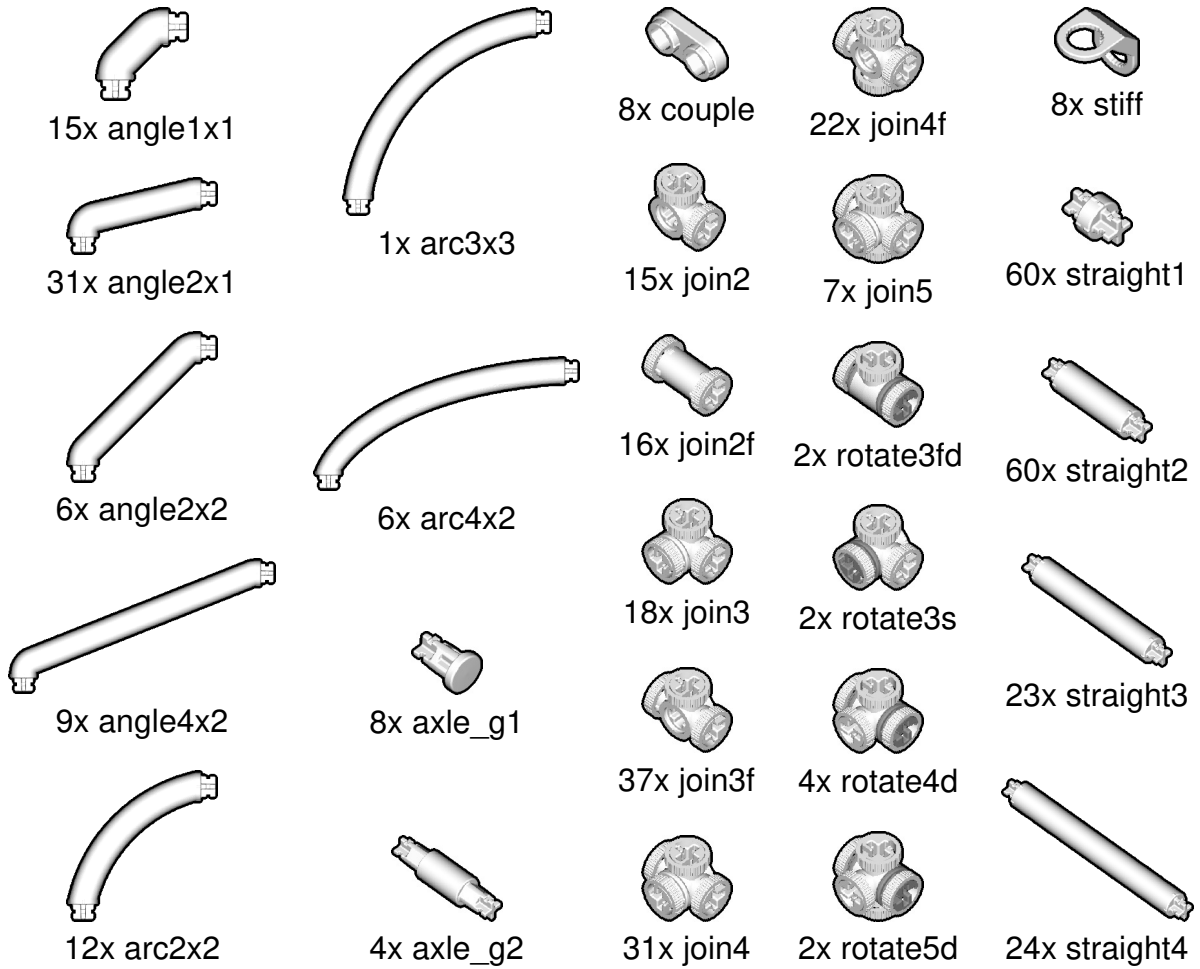

ACTUAL SIZE

