

SIZE	2.4ft x 1.8ft x 0.7ft	PIECES	264
DESIGNER	Charles Sharman	MADE IN	U.S.A.

# JET FIGHTER

⚠ WARNING: Small parts. Age 14+. Not a toy. Handle responsibly. U.S. Patent 9,086,087.



Wrong  
Connecting/Disconnecting Two Directions

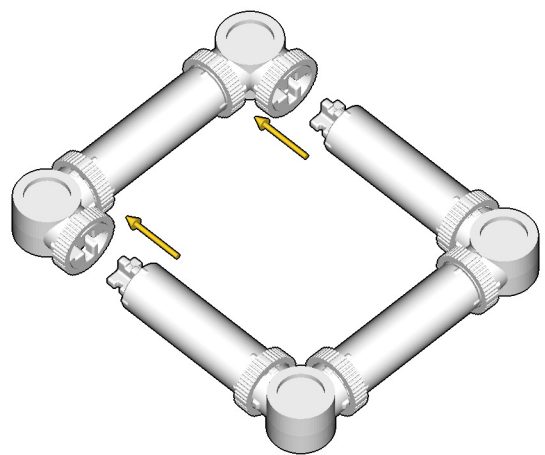

Right  
Connecting/Disconnecting One Direction

1

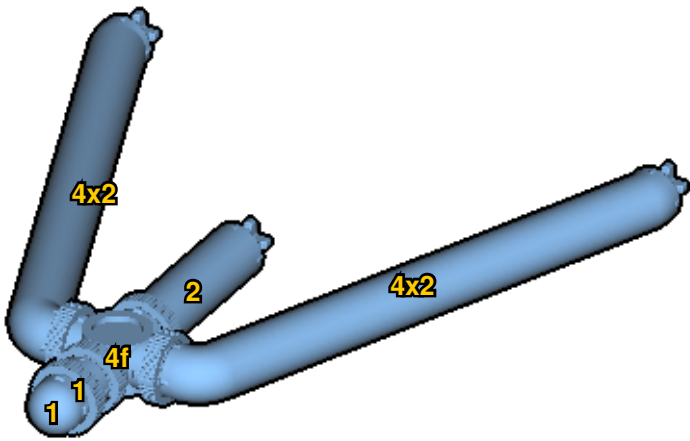

New pieces are drawn blue. Old pieces are drawn white.  
See back for piece names.

2

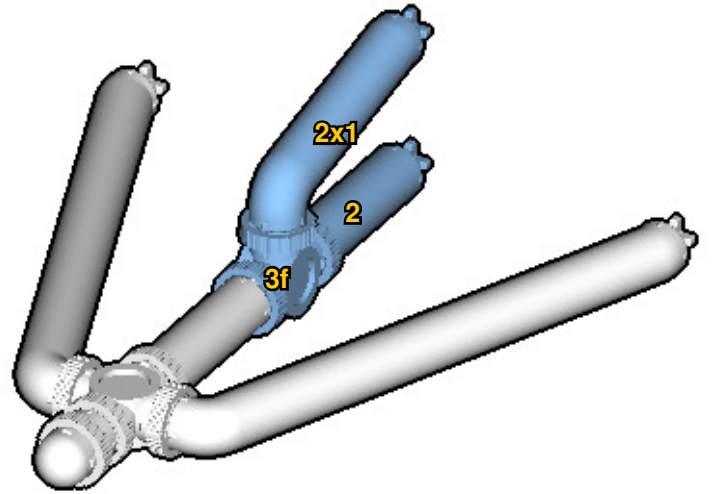

Connect new pieces together before connecting to old pieces.

3

Submodel begins →

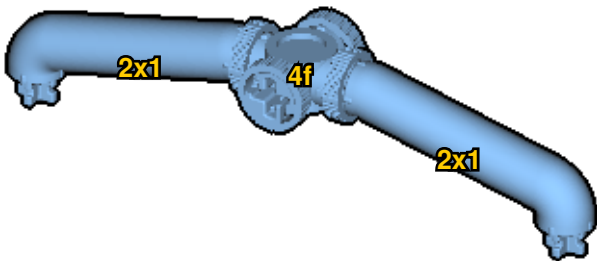

4

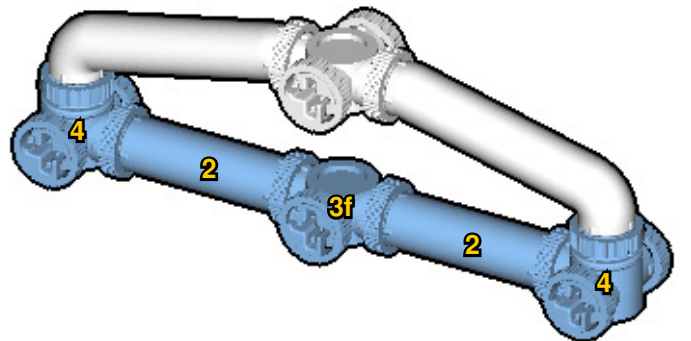

Submodel ends → **5**

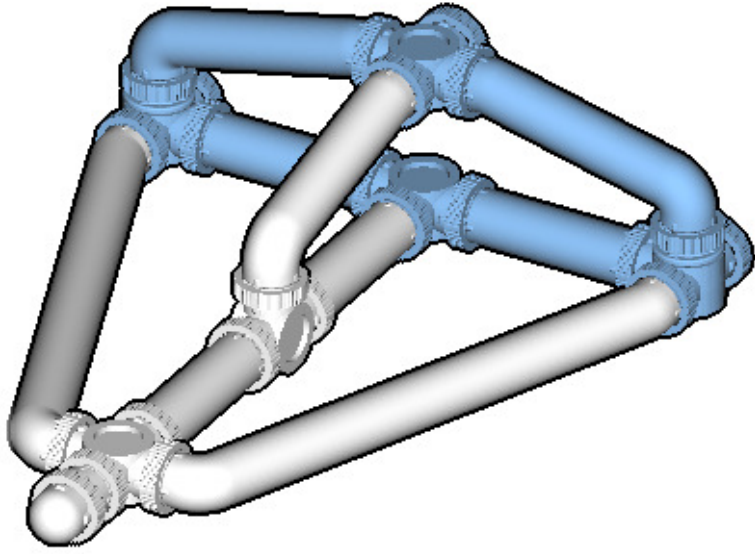

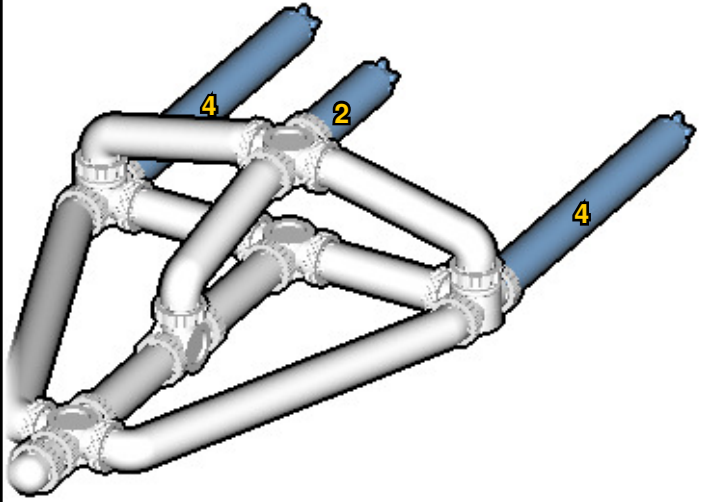

Connect submodel to model.

**6**

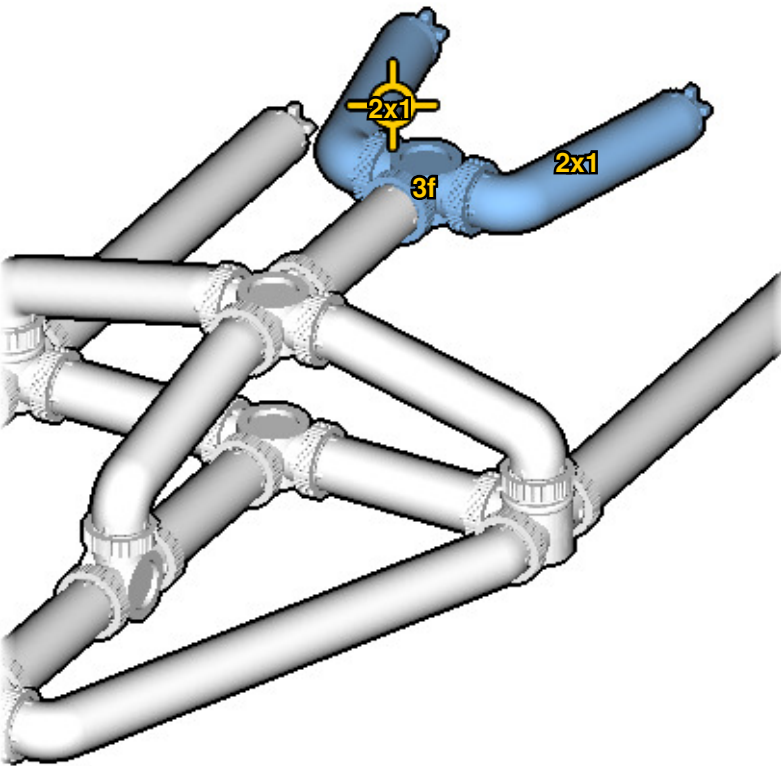

**7**



 : The next frame is centered on this piece.

**8**

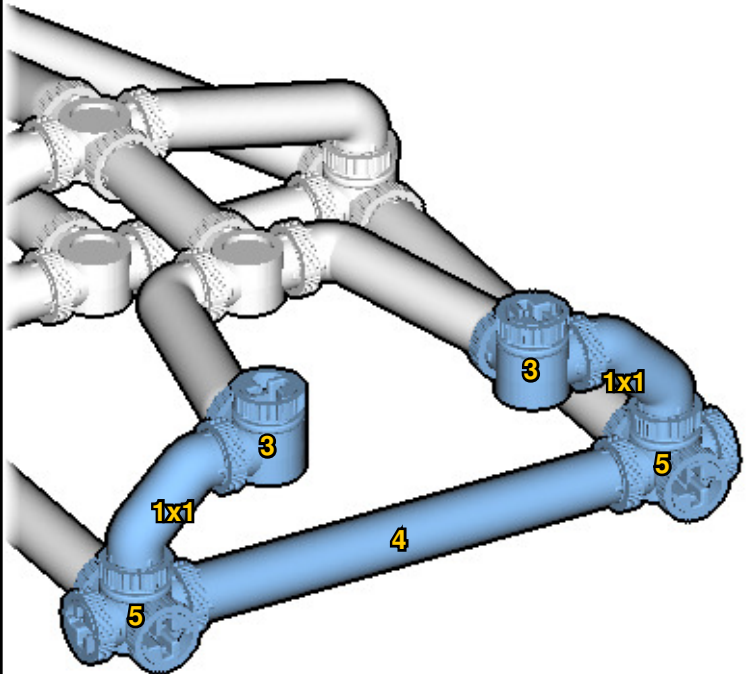

9

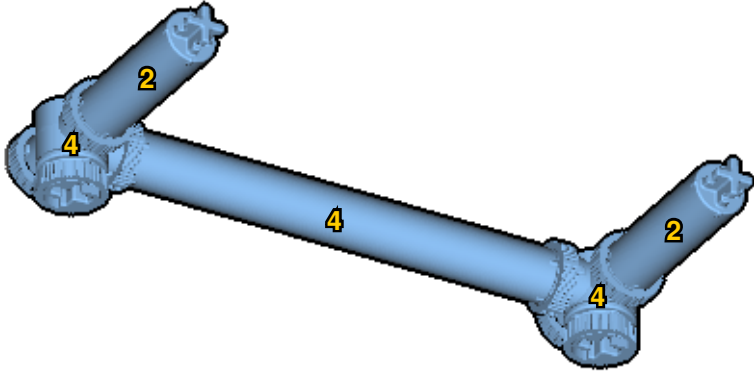

10

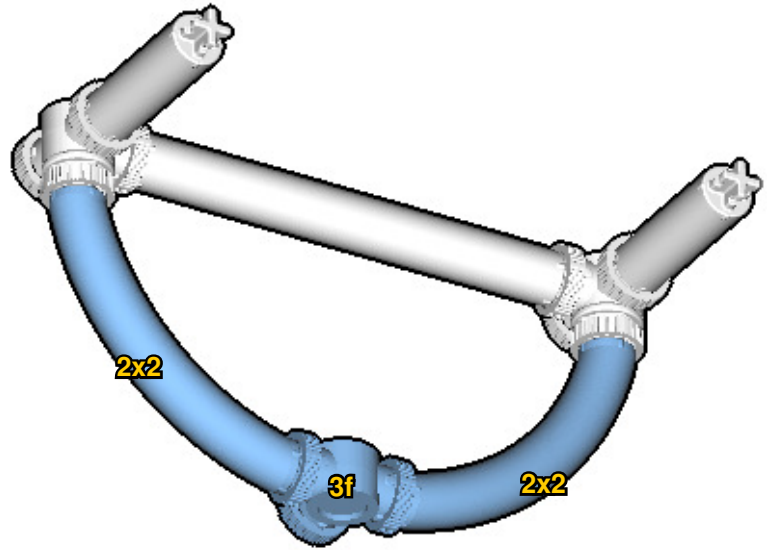

11

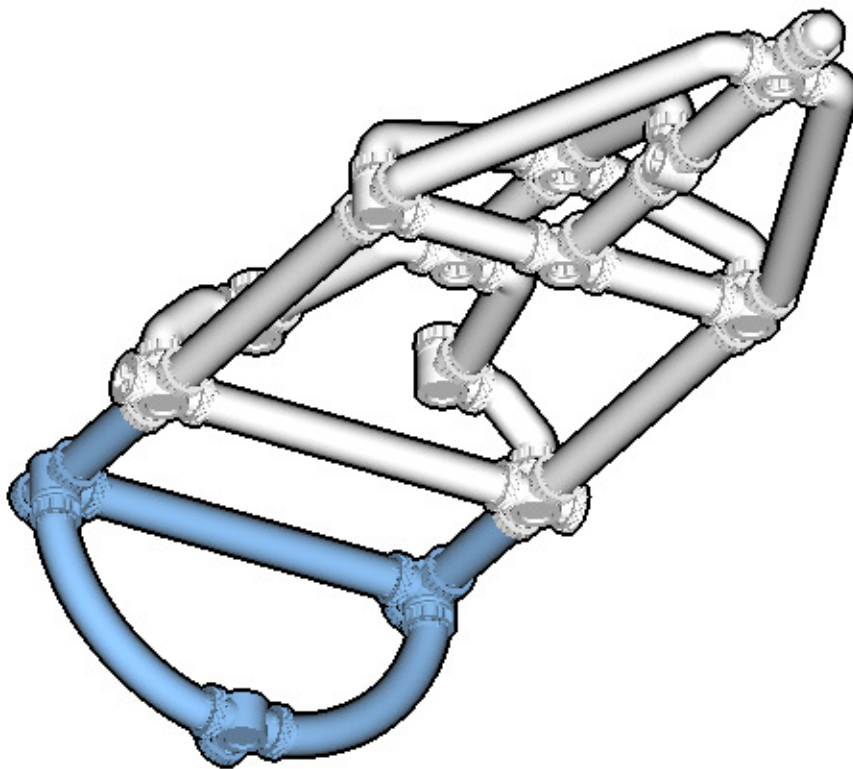

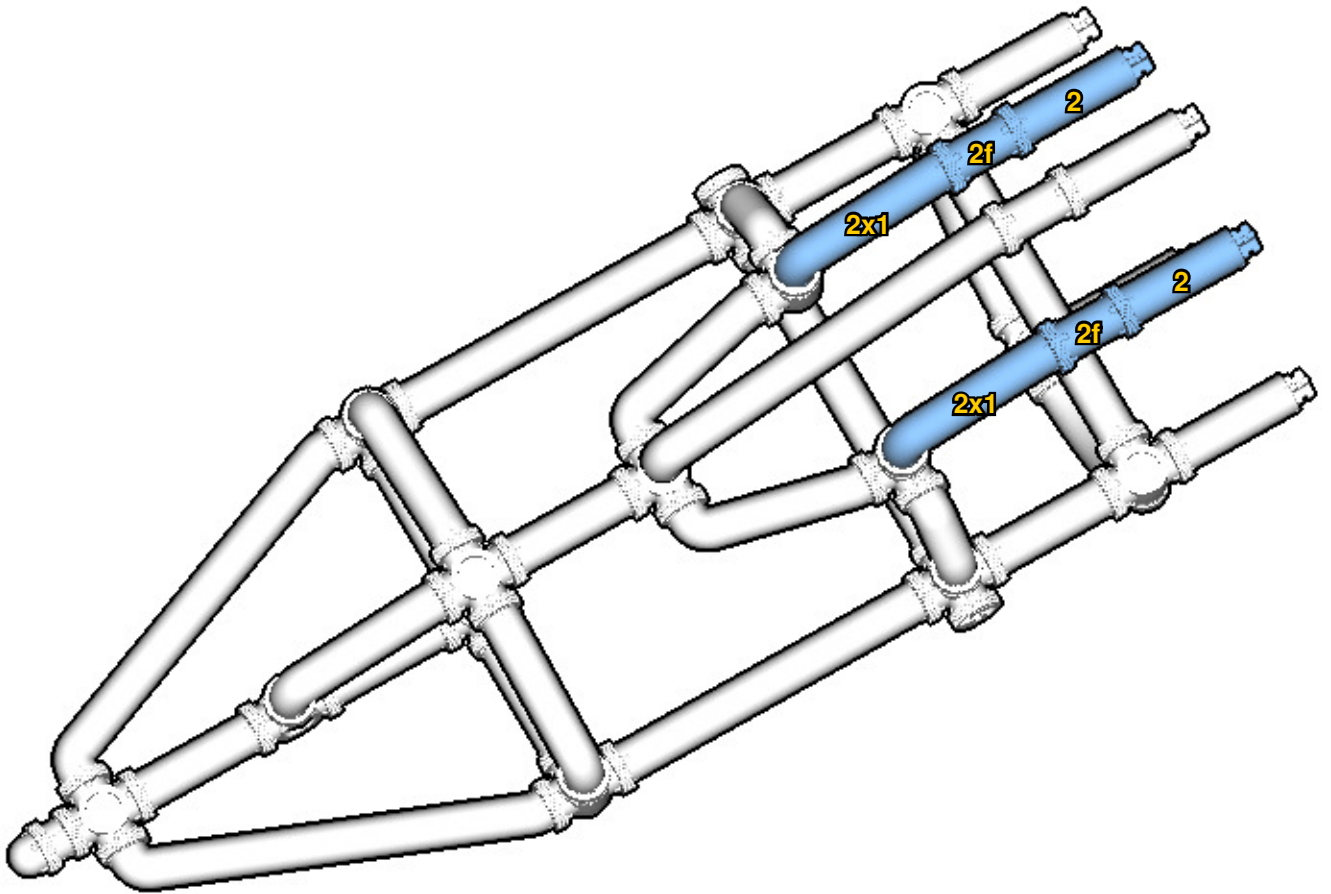
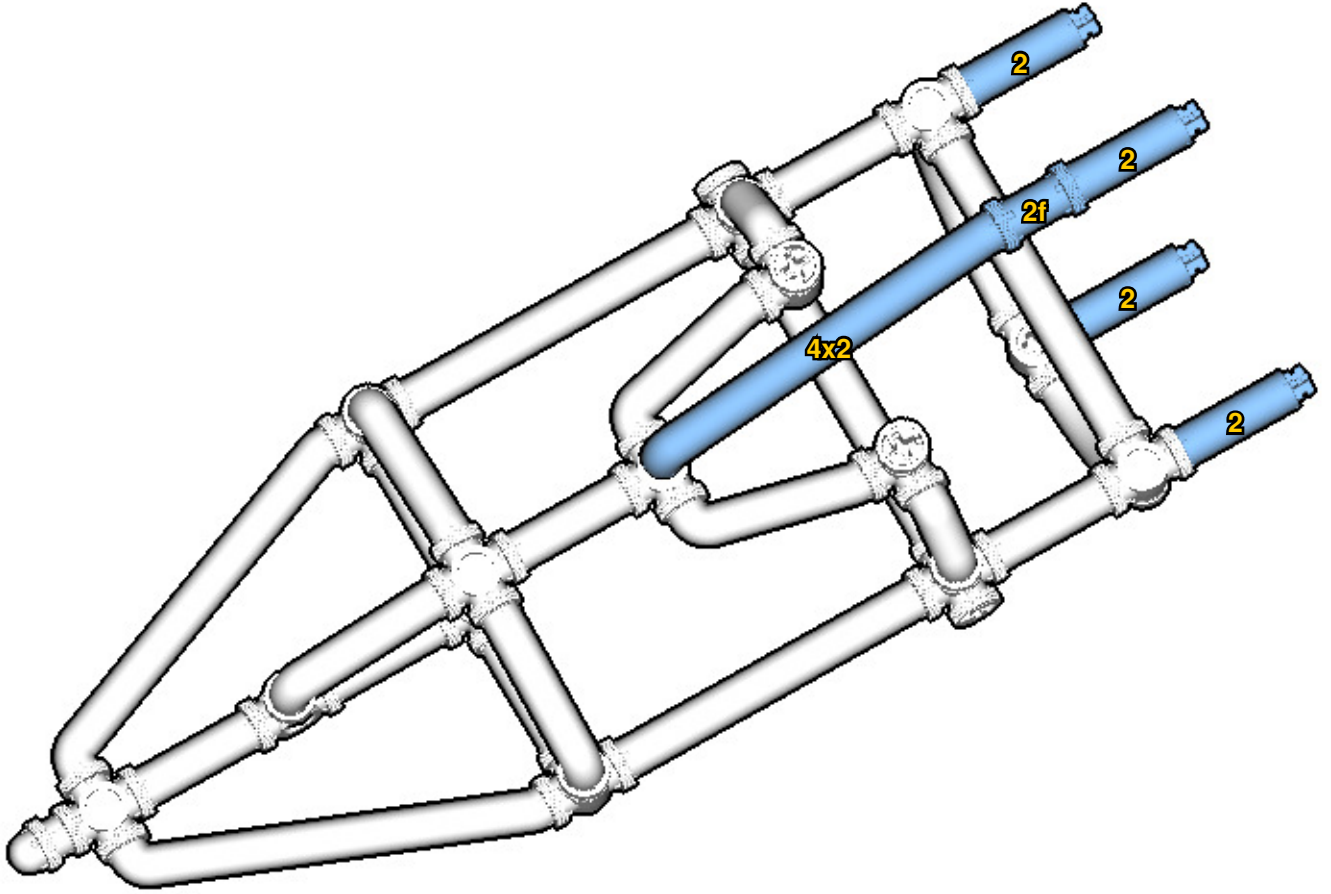

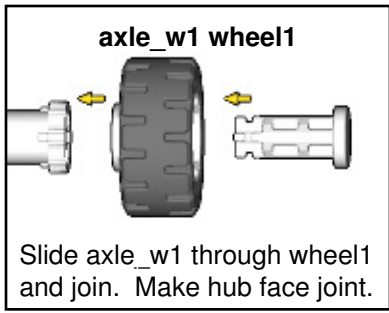

14

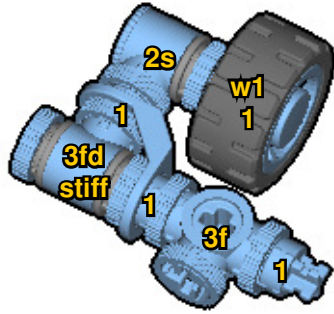

15

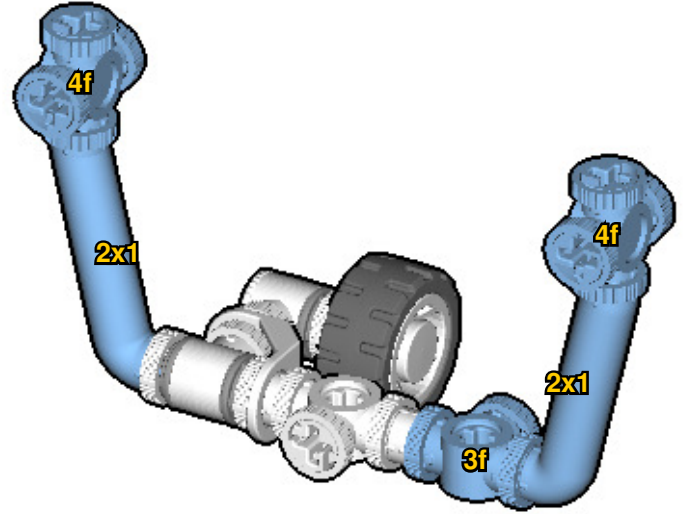

16

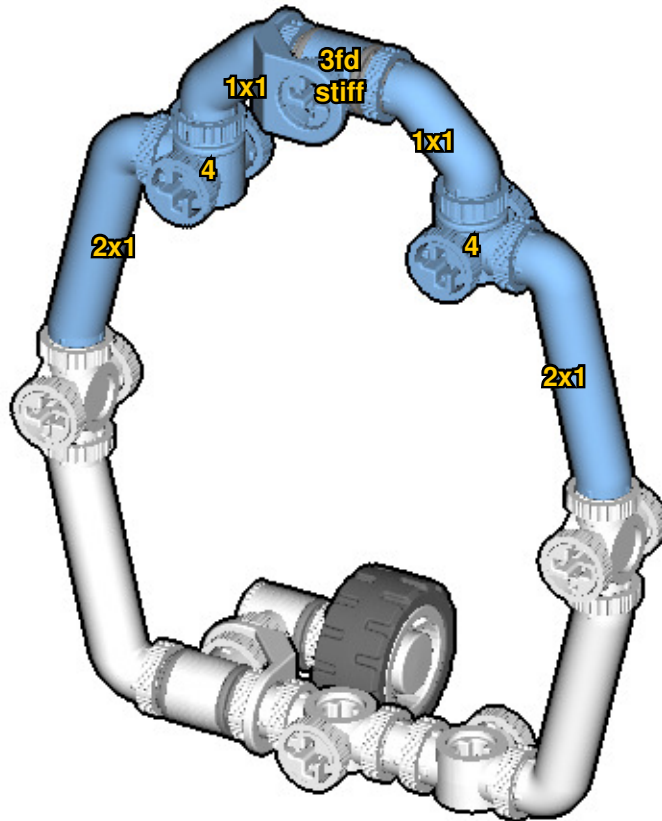

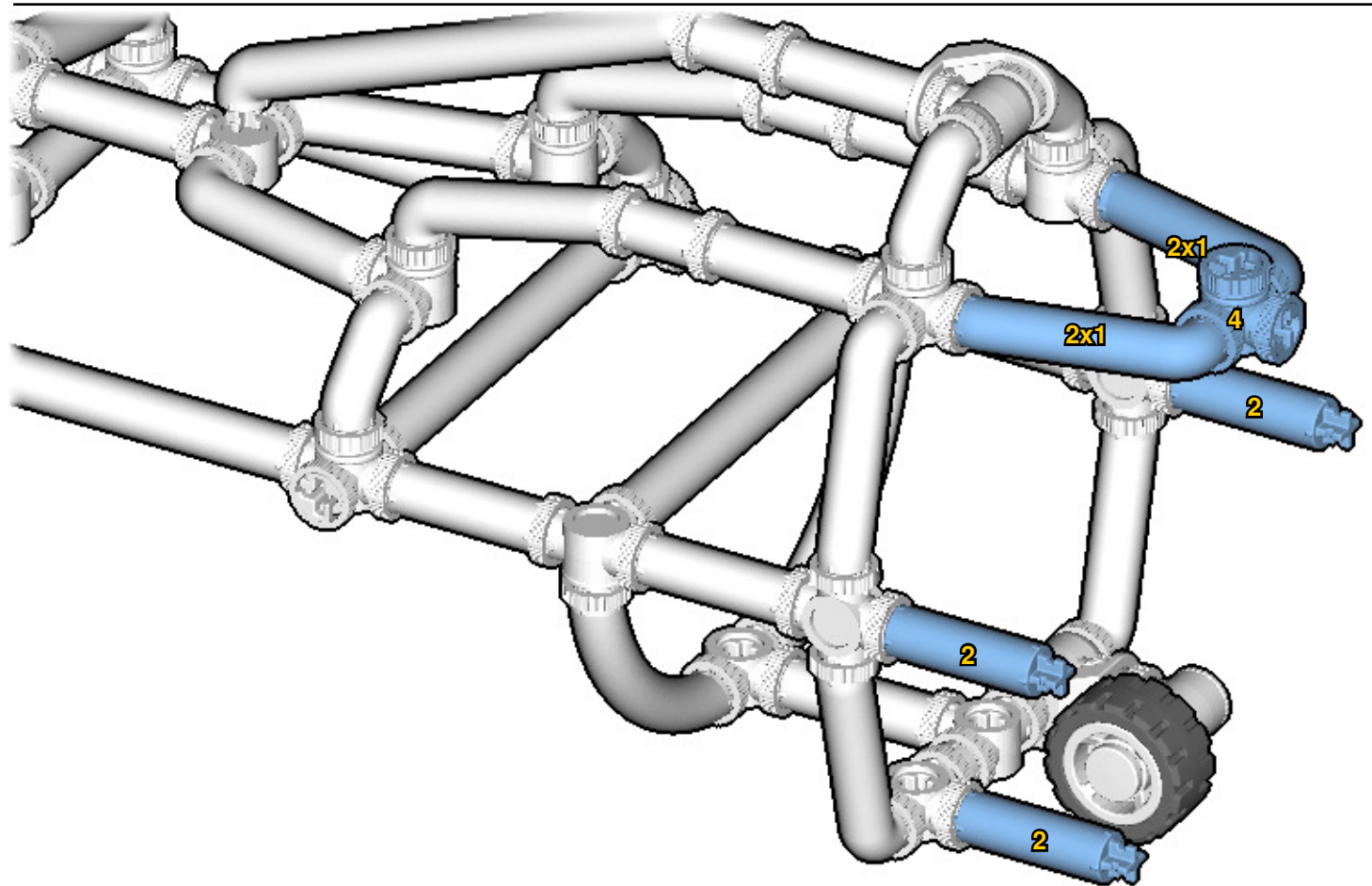
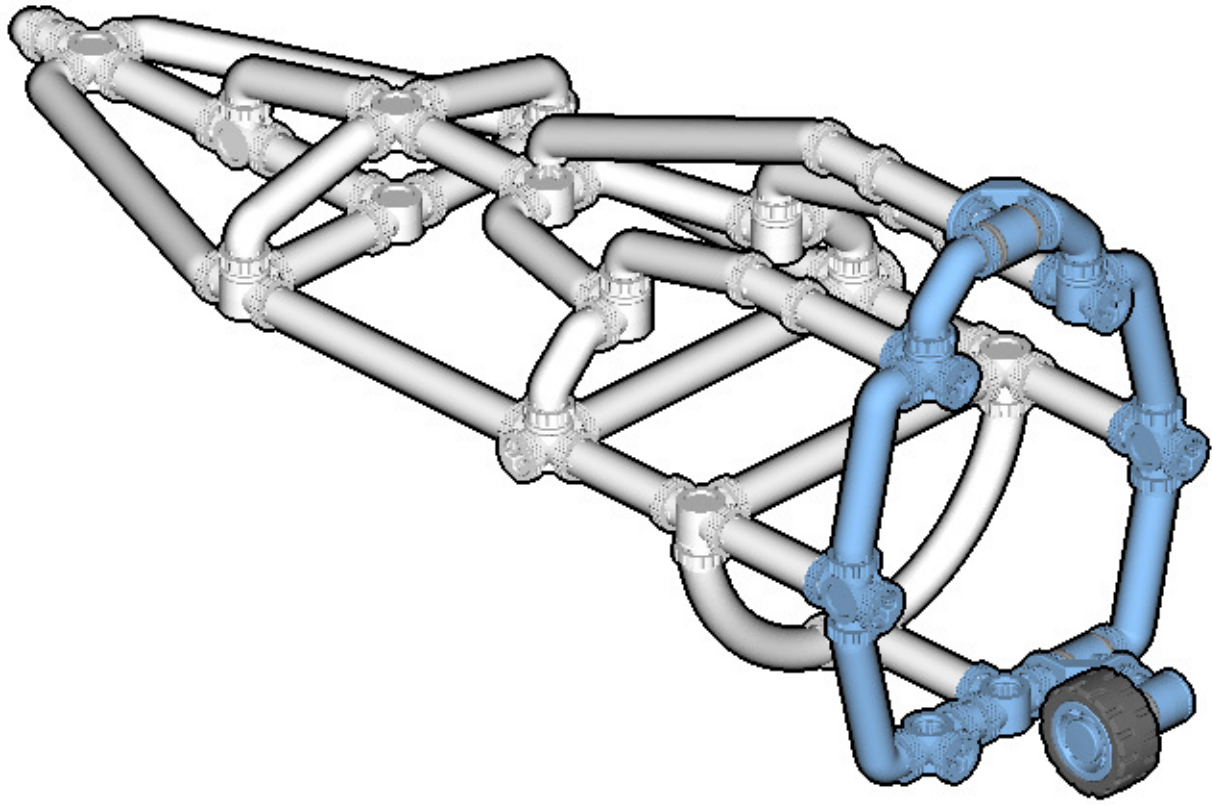



19

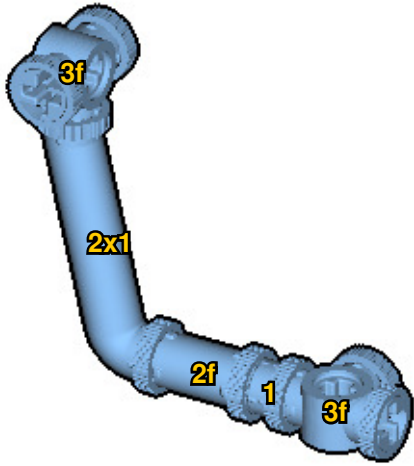

20

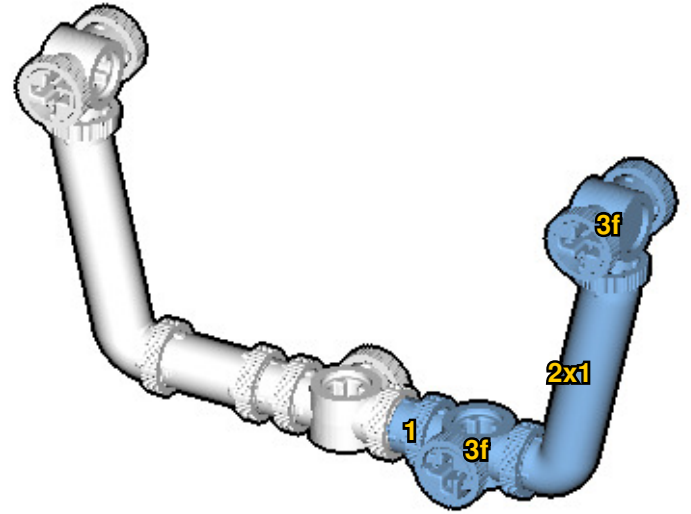

21

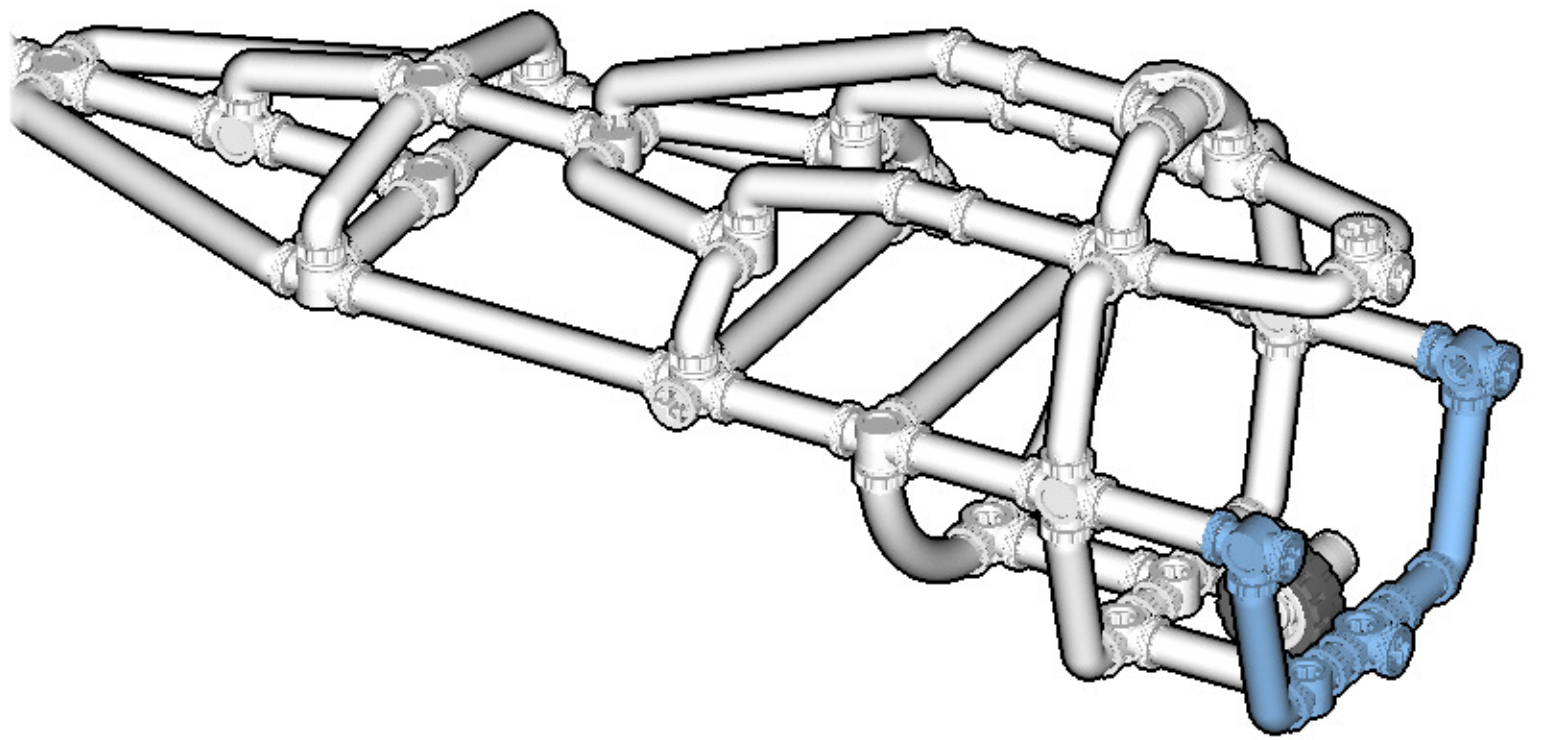

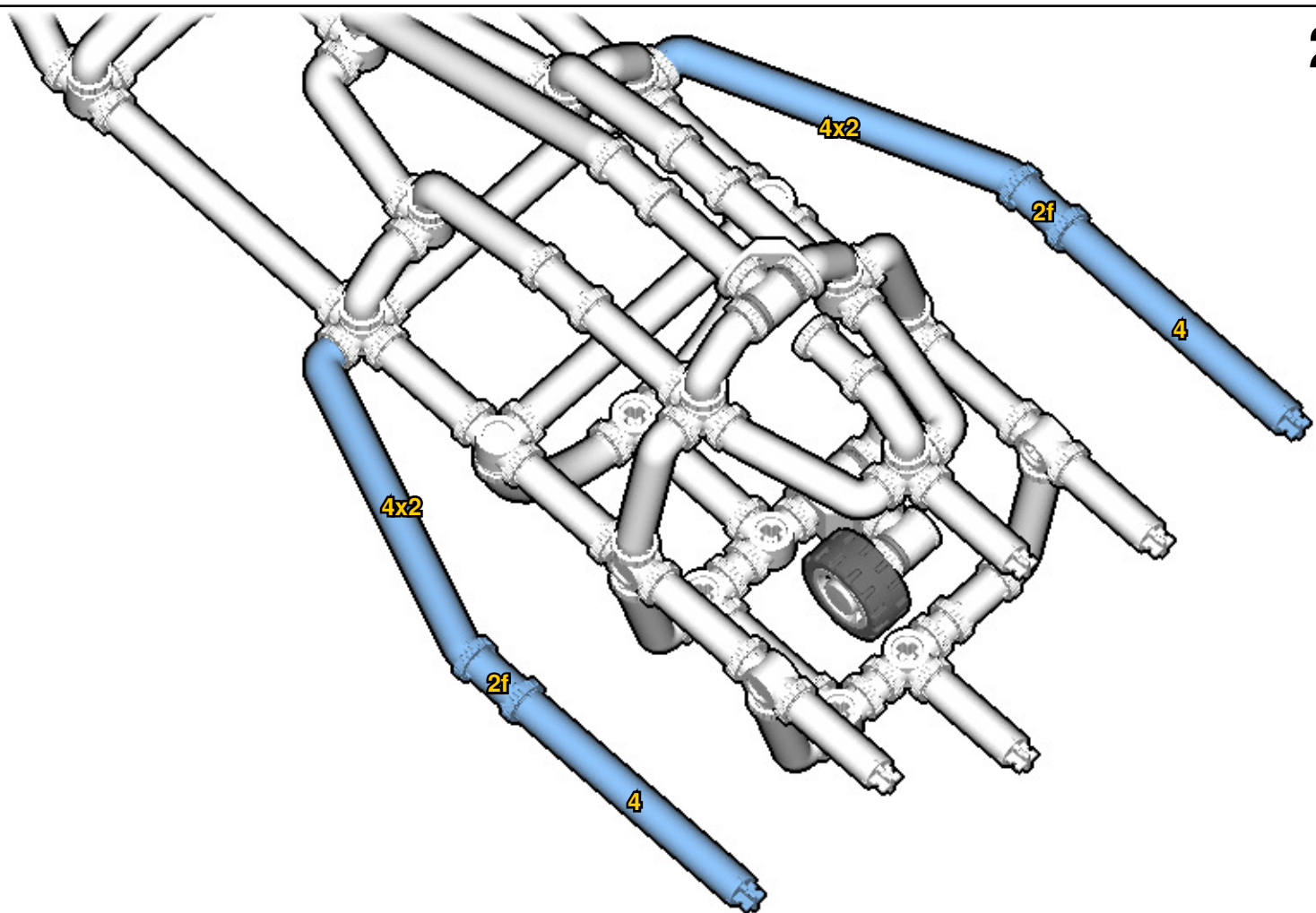
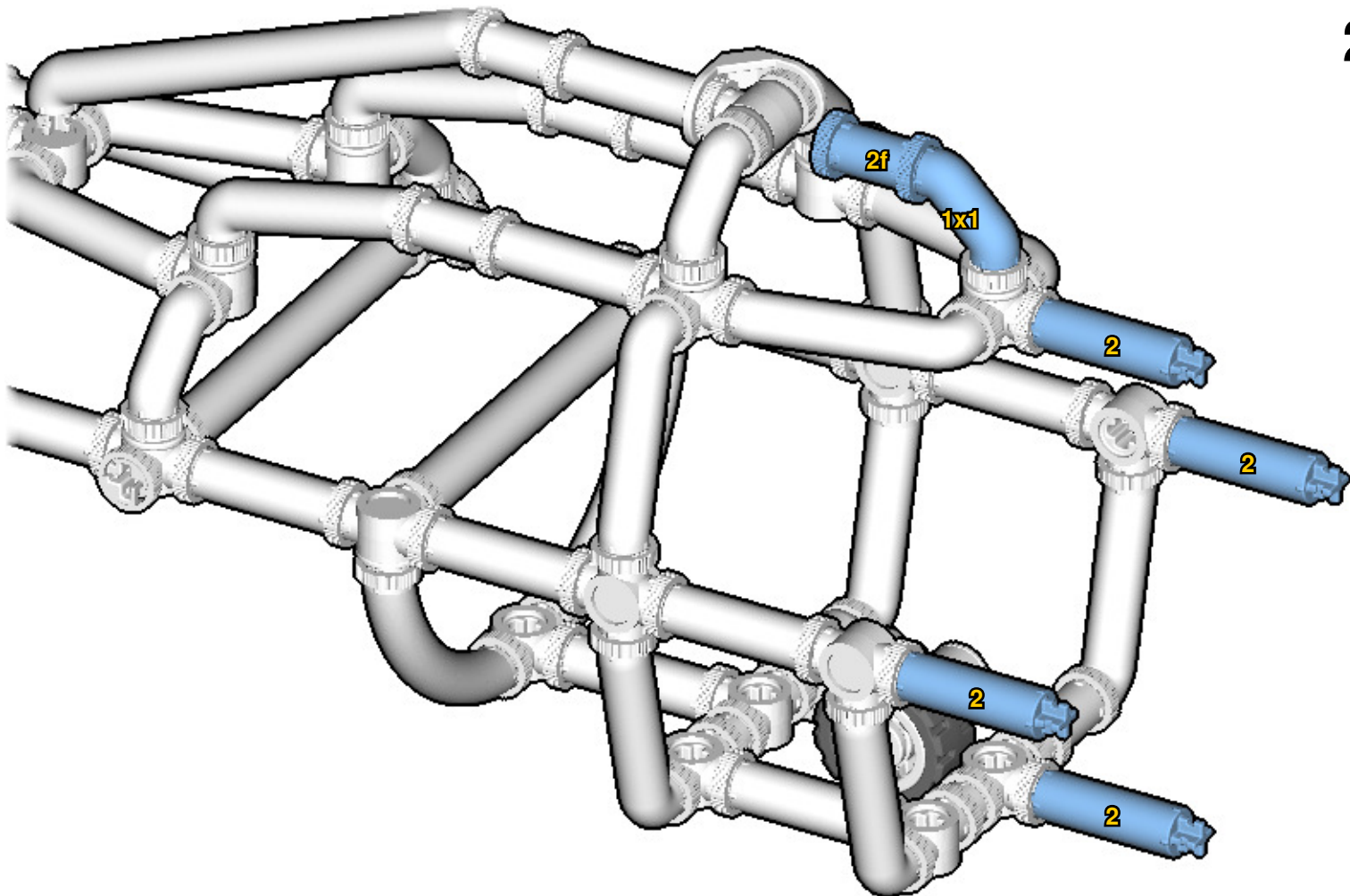

24

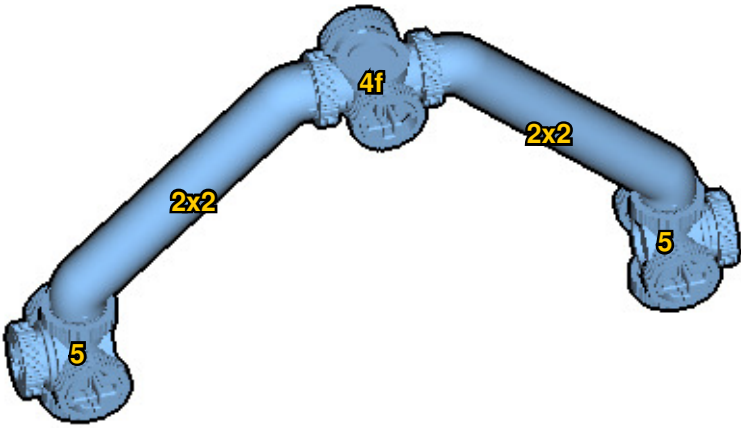

25

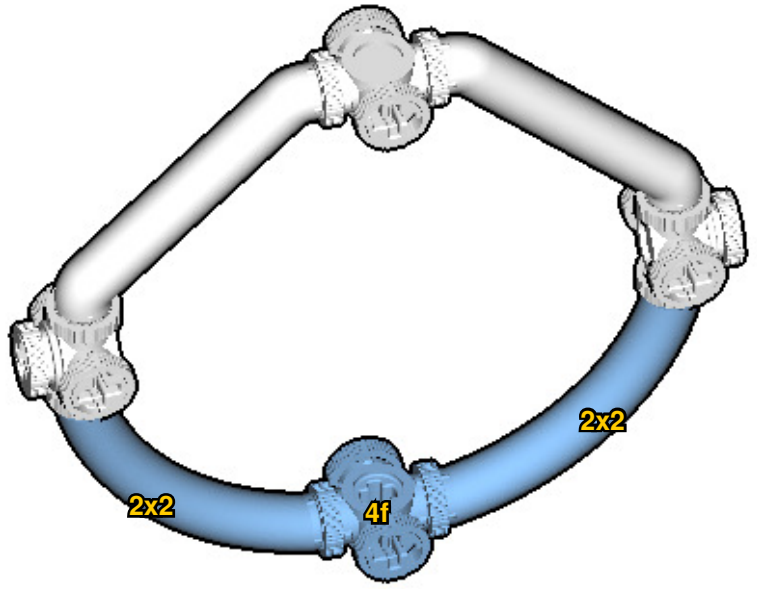

26

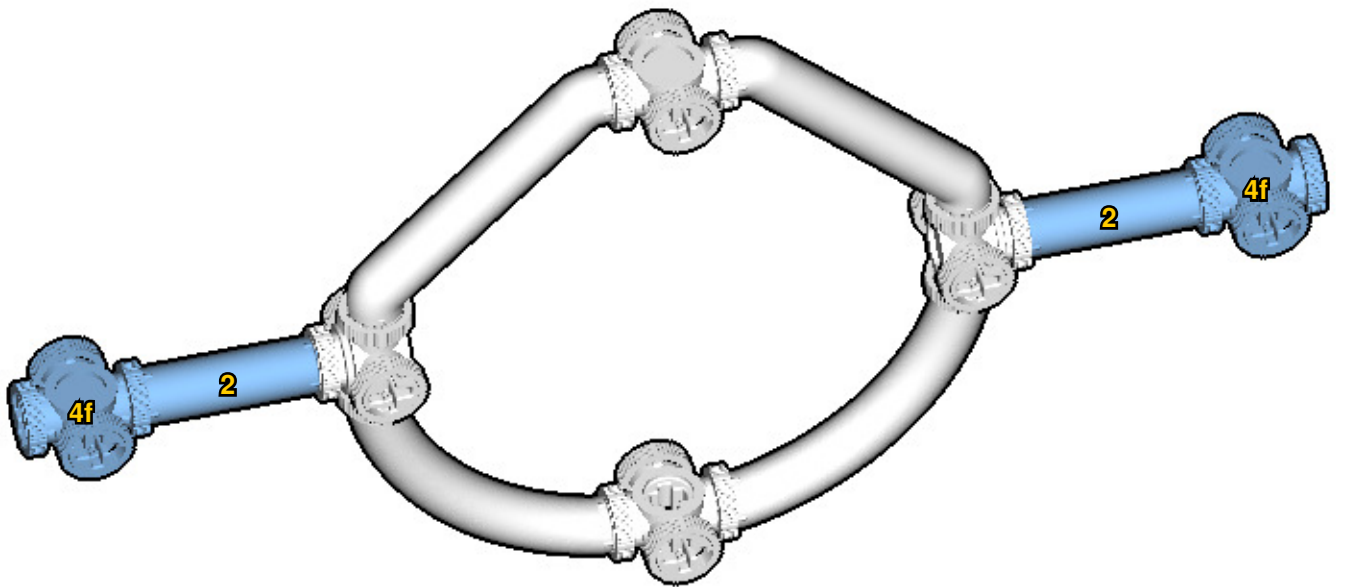

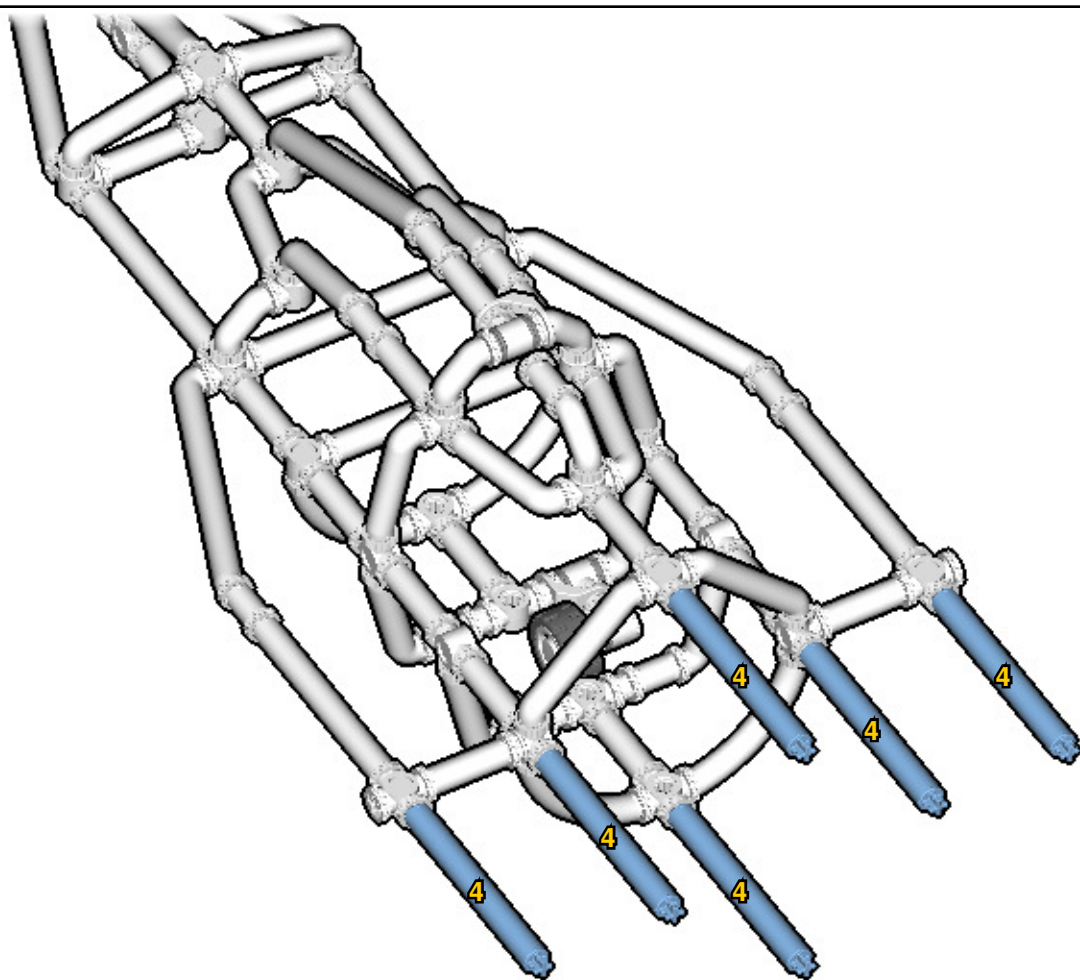
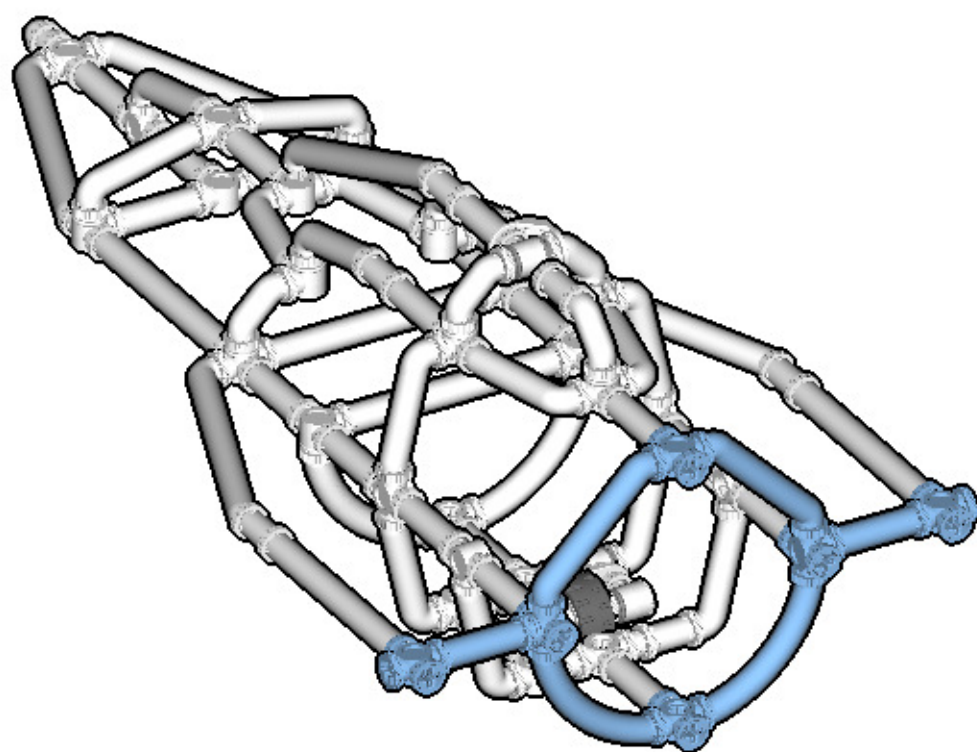

29

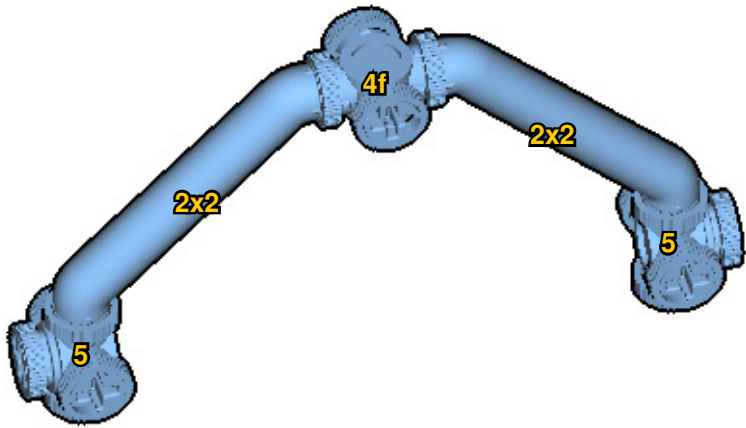

30

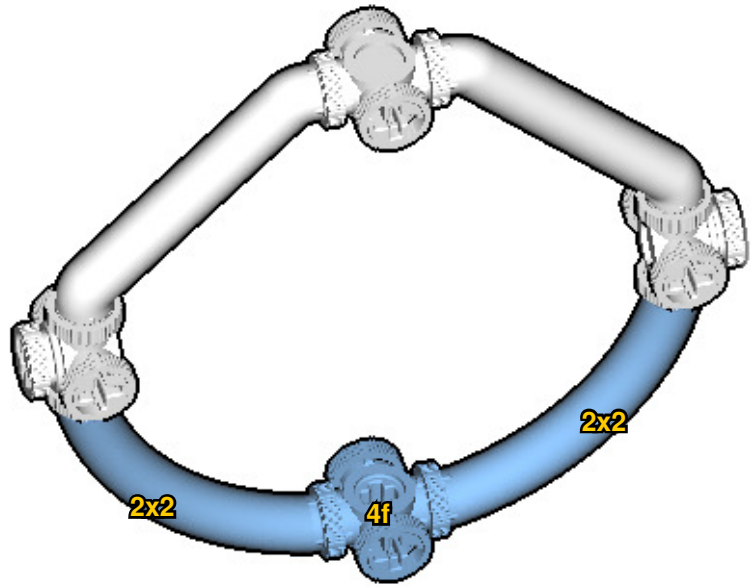

31

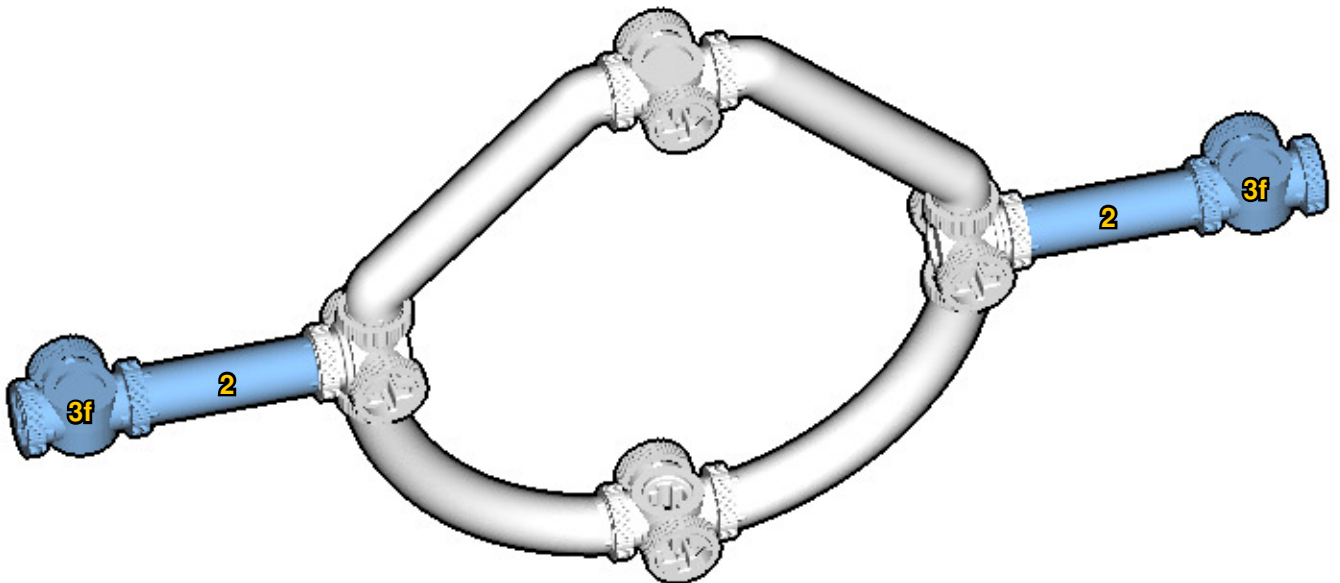

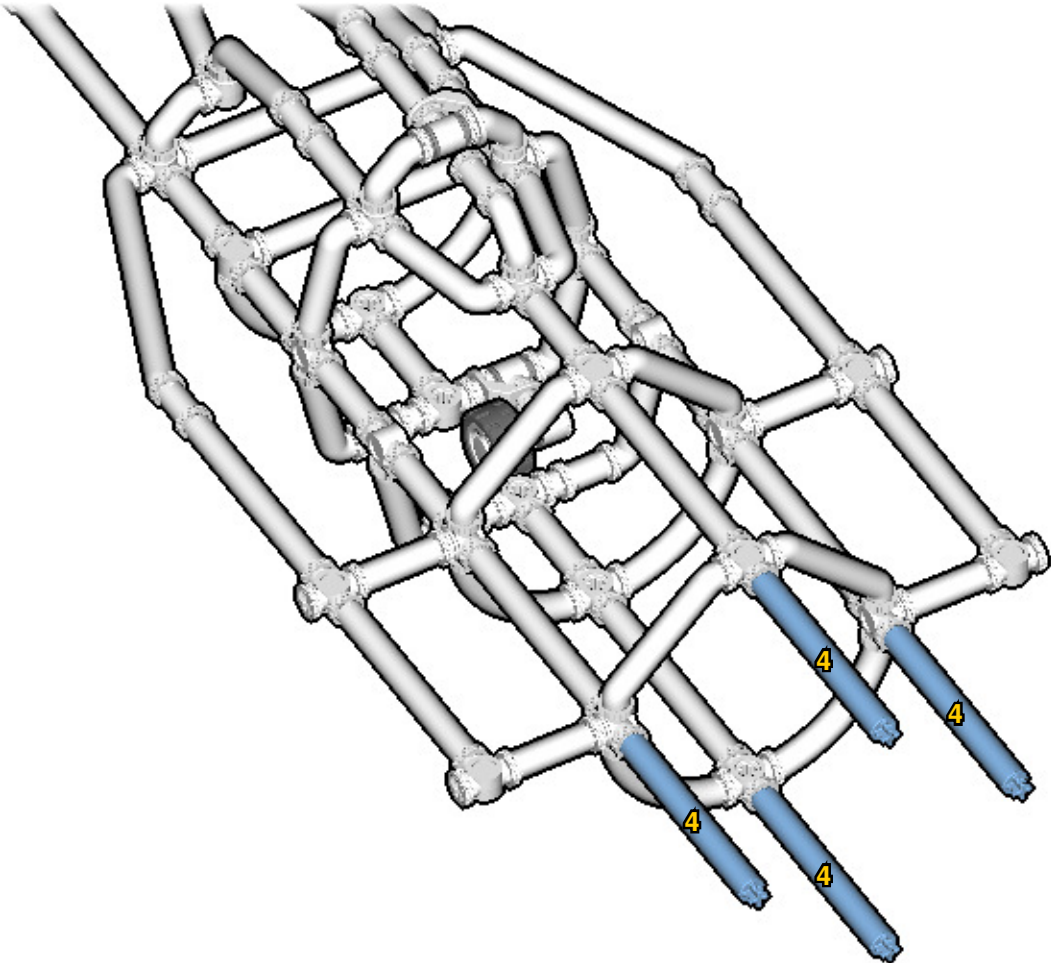
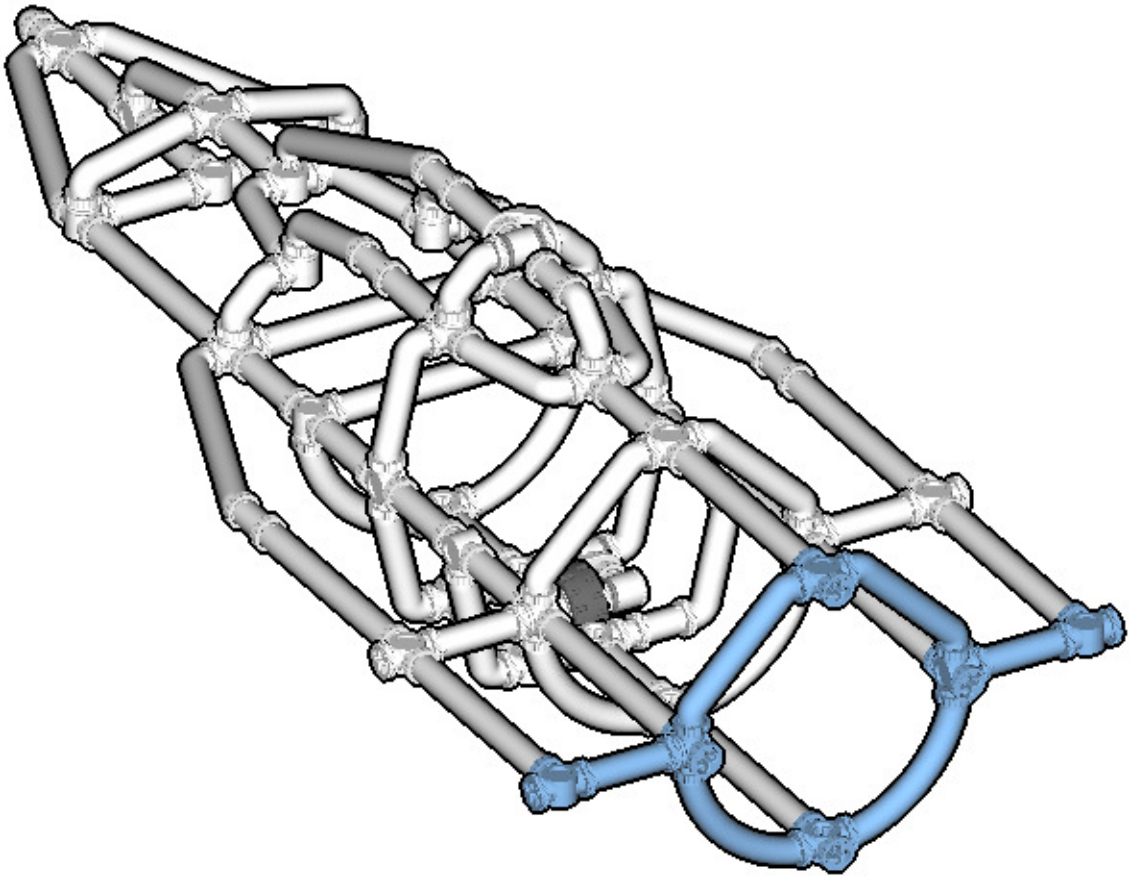

34

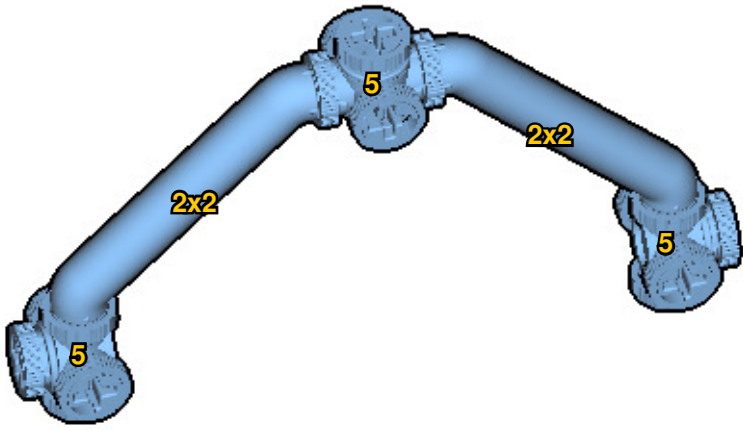

35

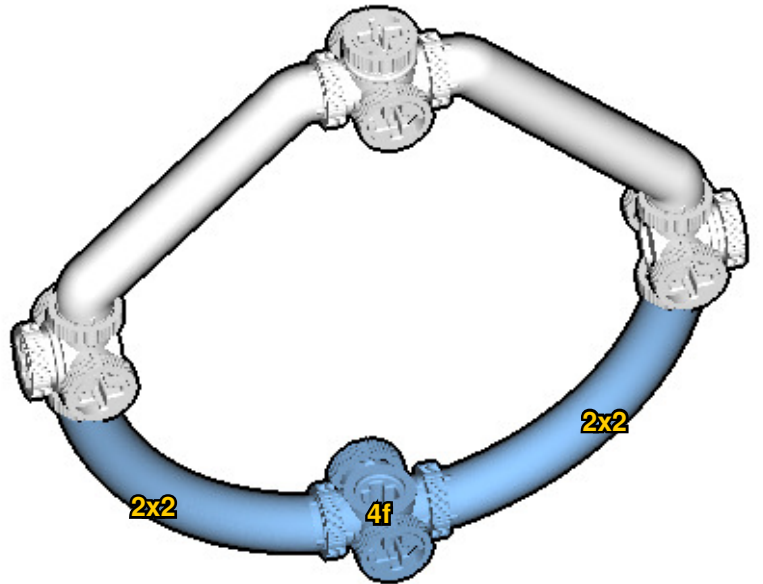

36

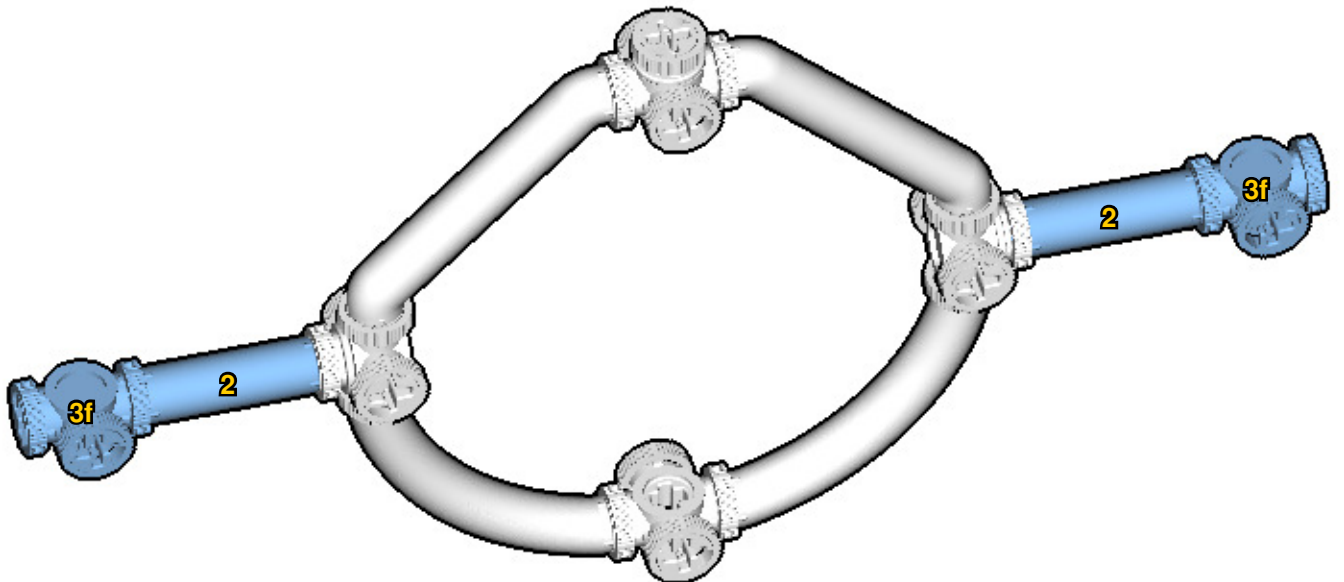

37

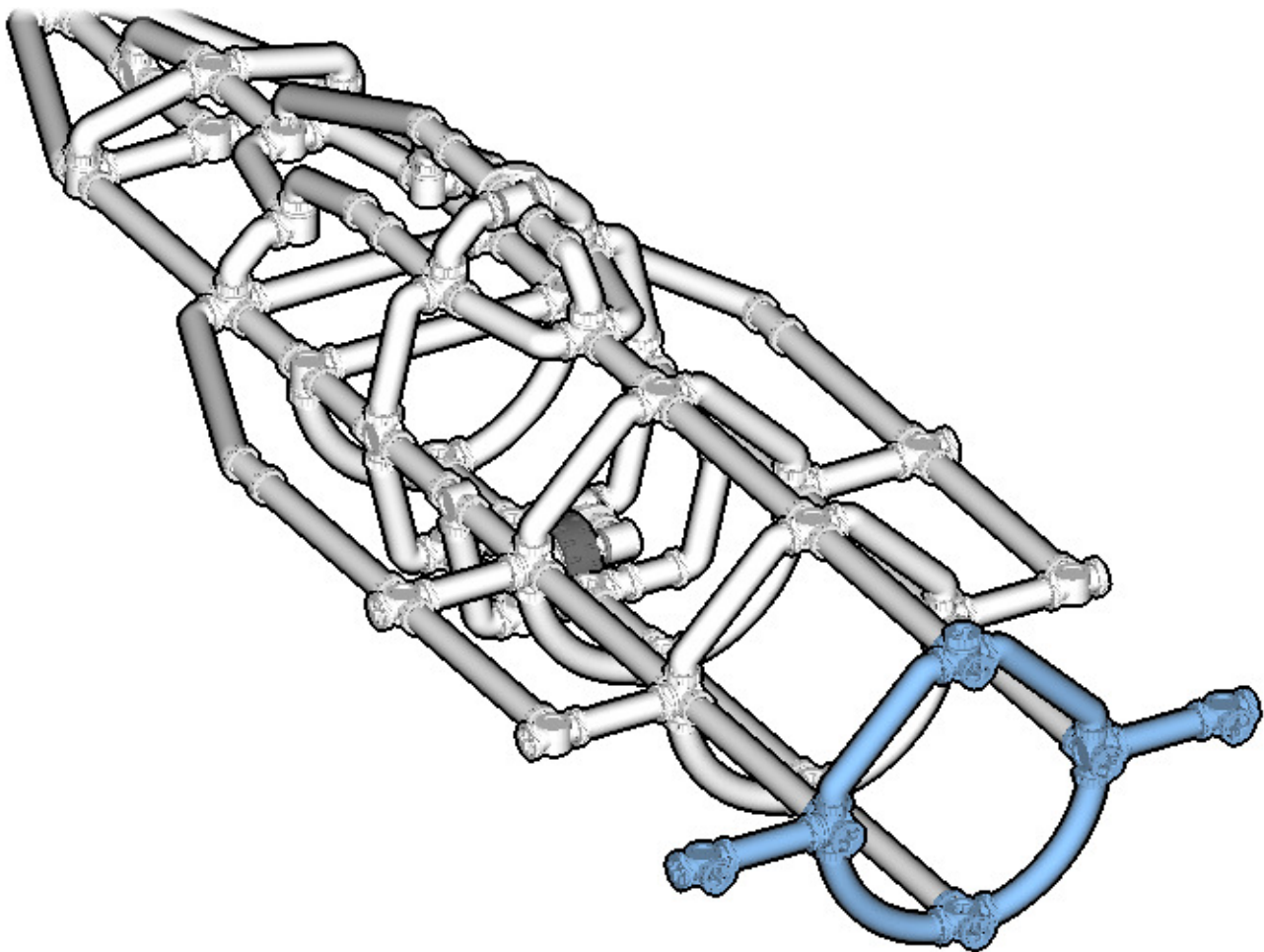

38

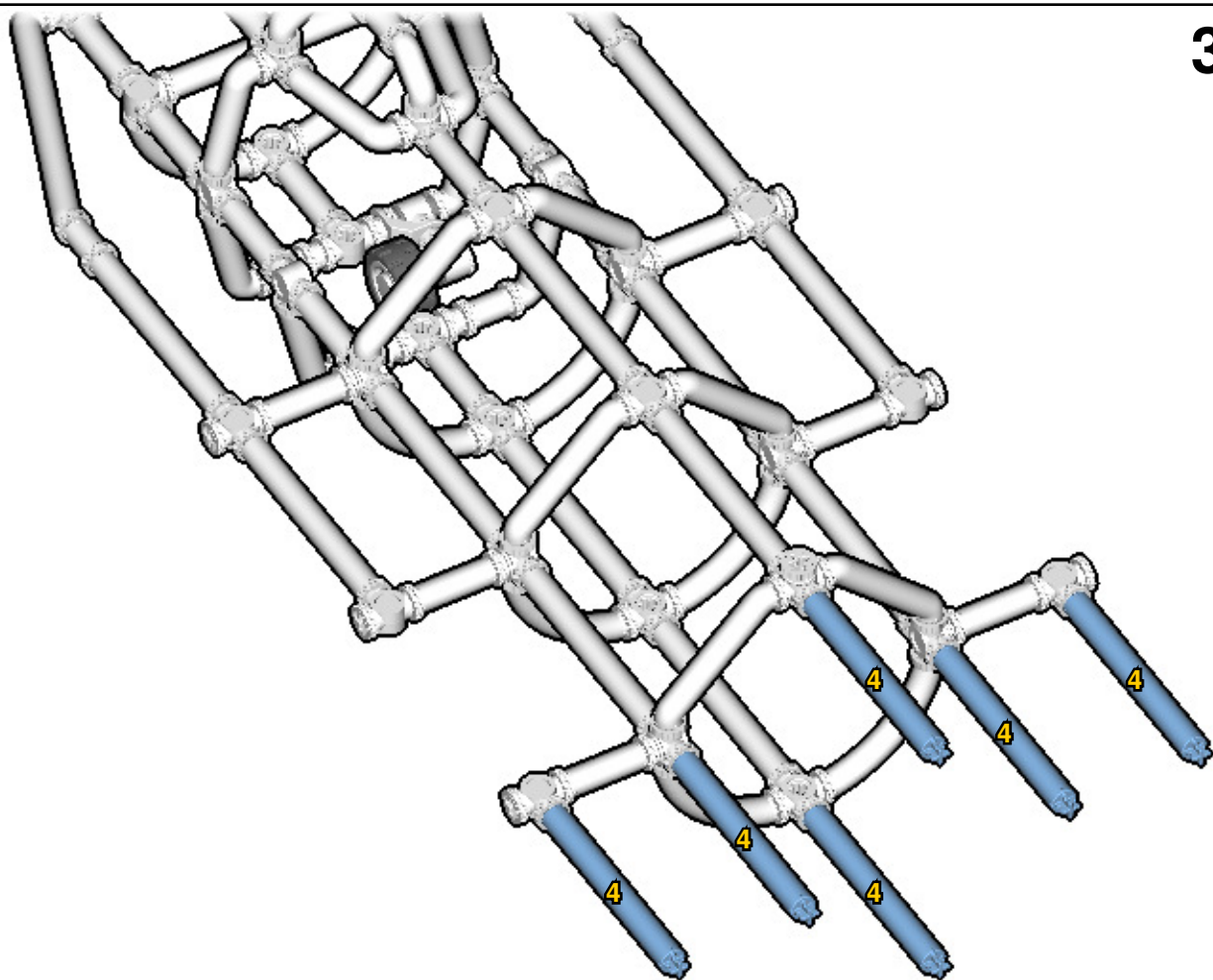



39

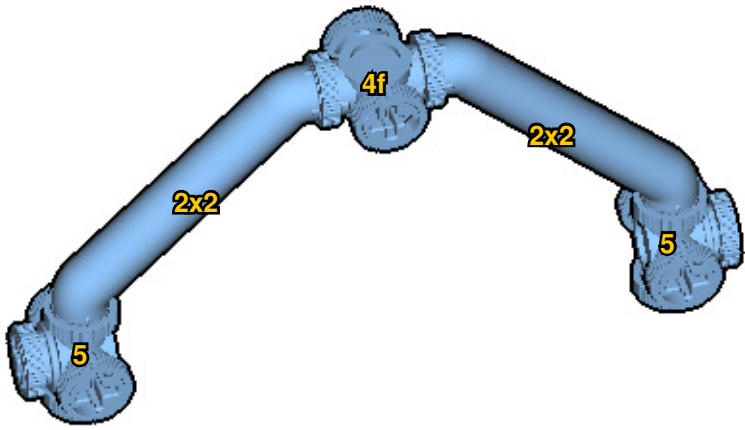

40

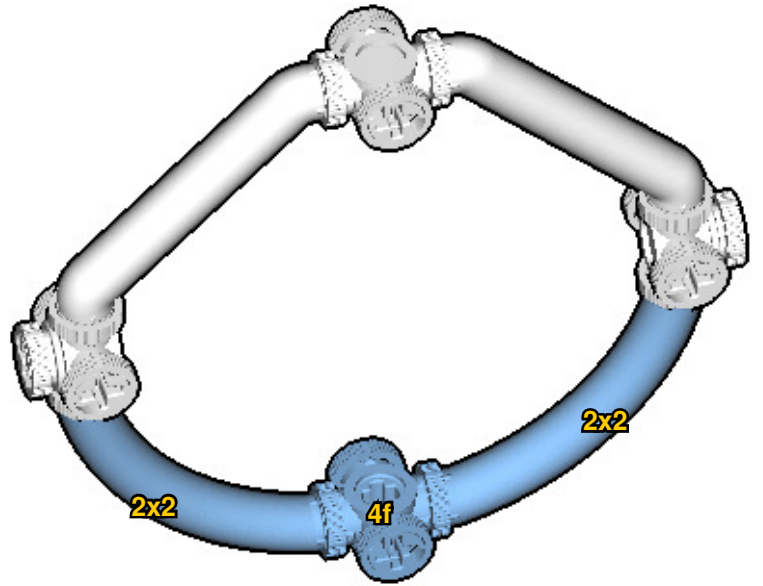

41

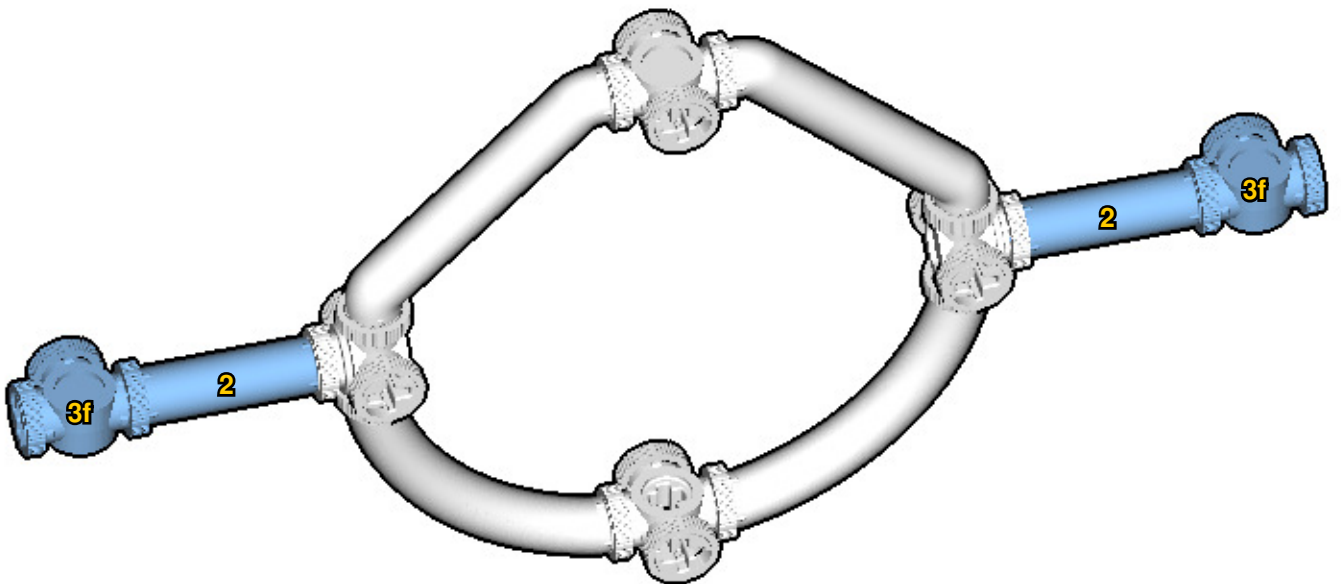

42

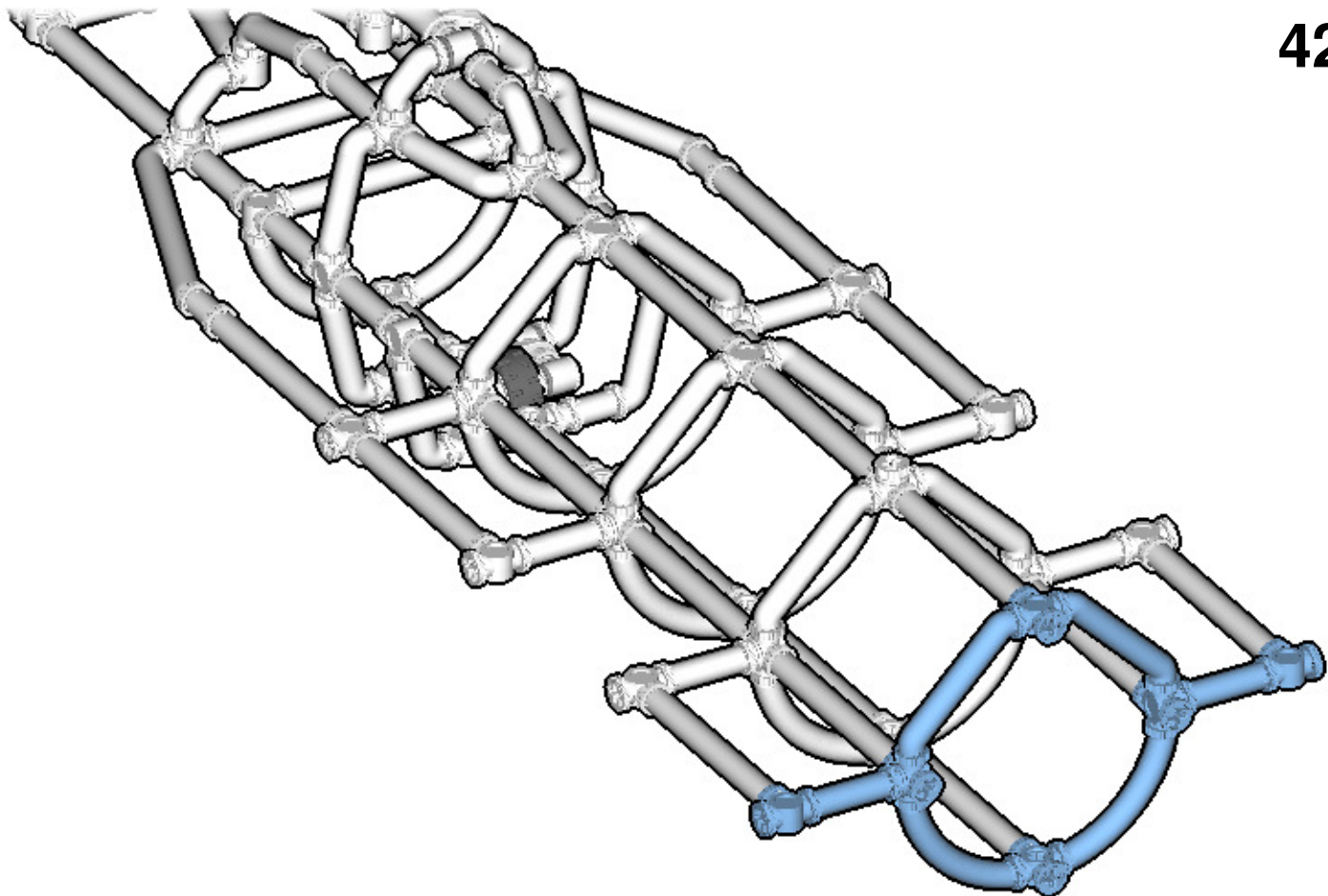

43

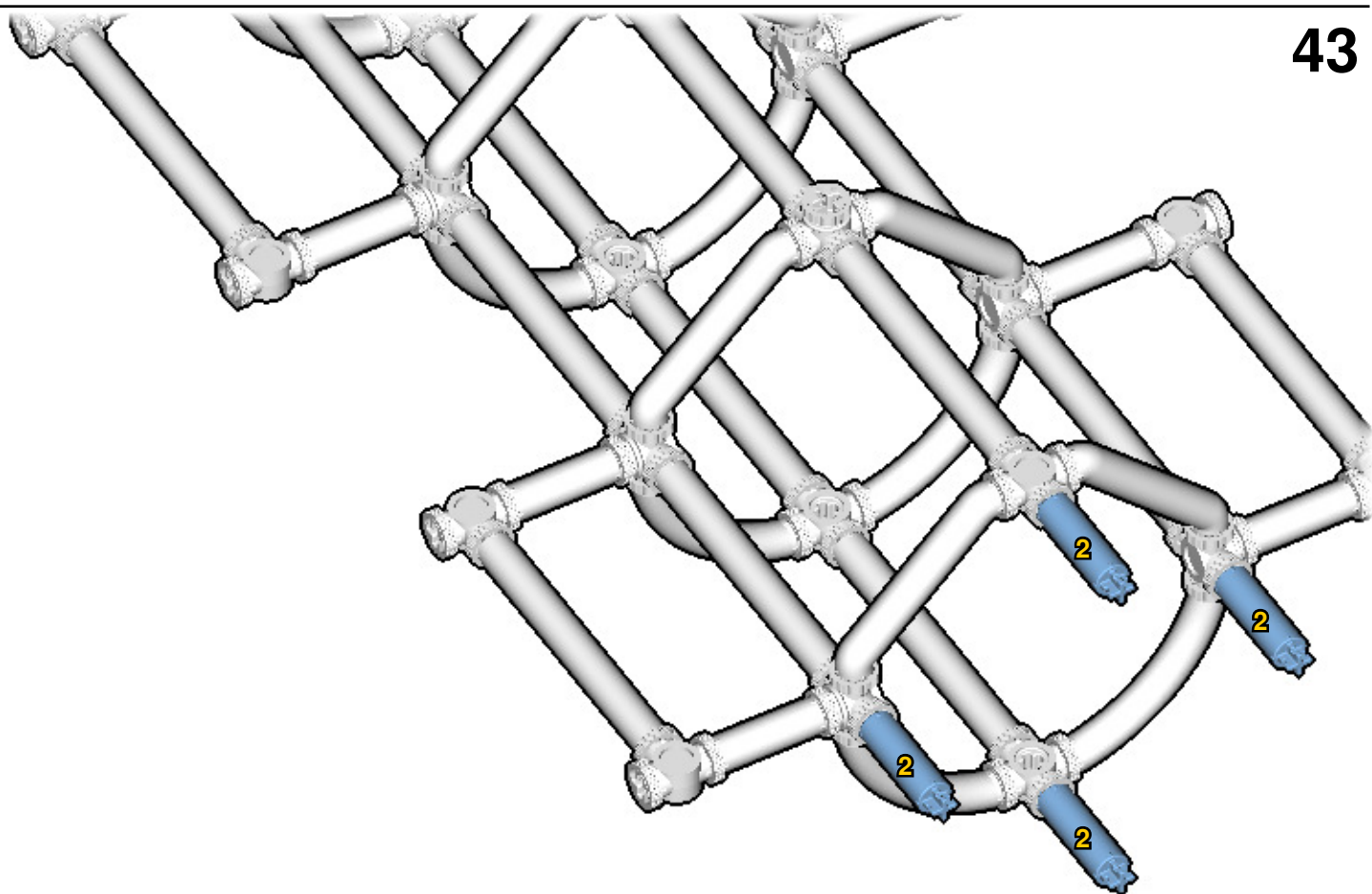

44

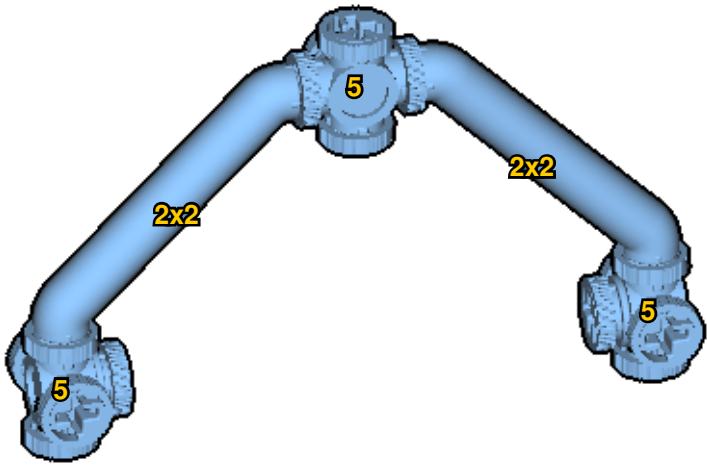

45

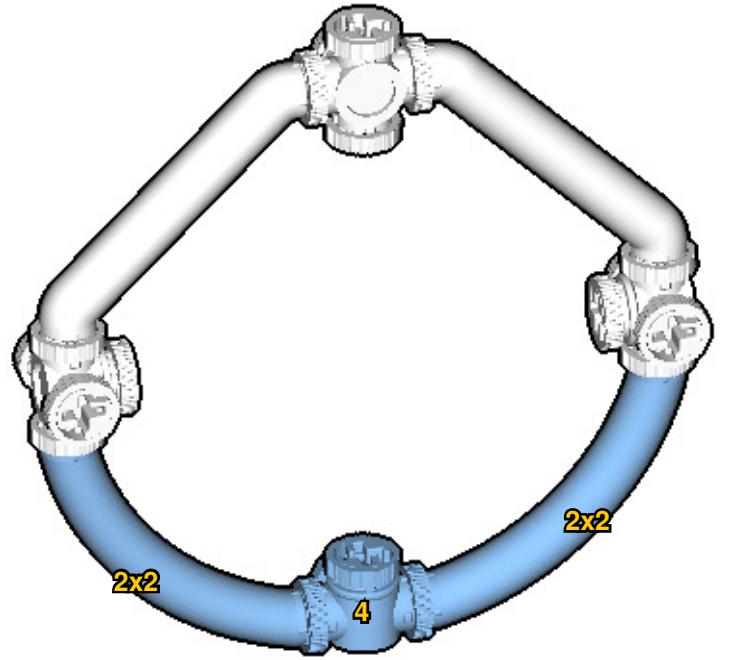

46

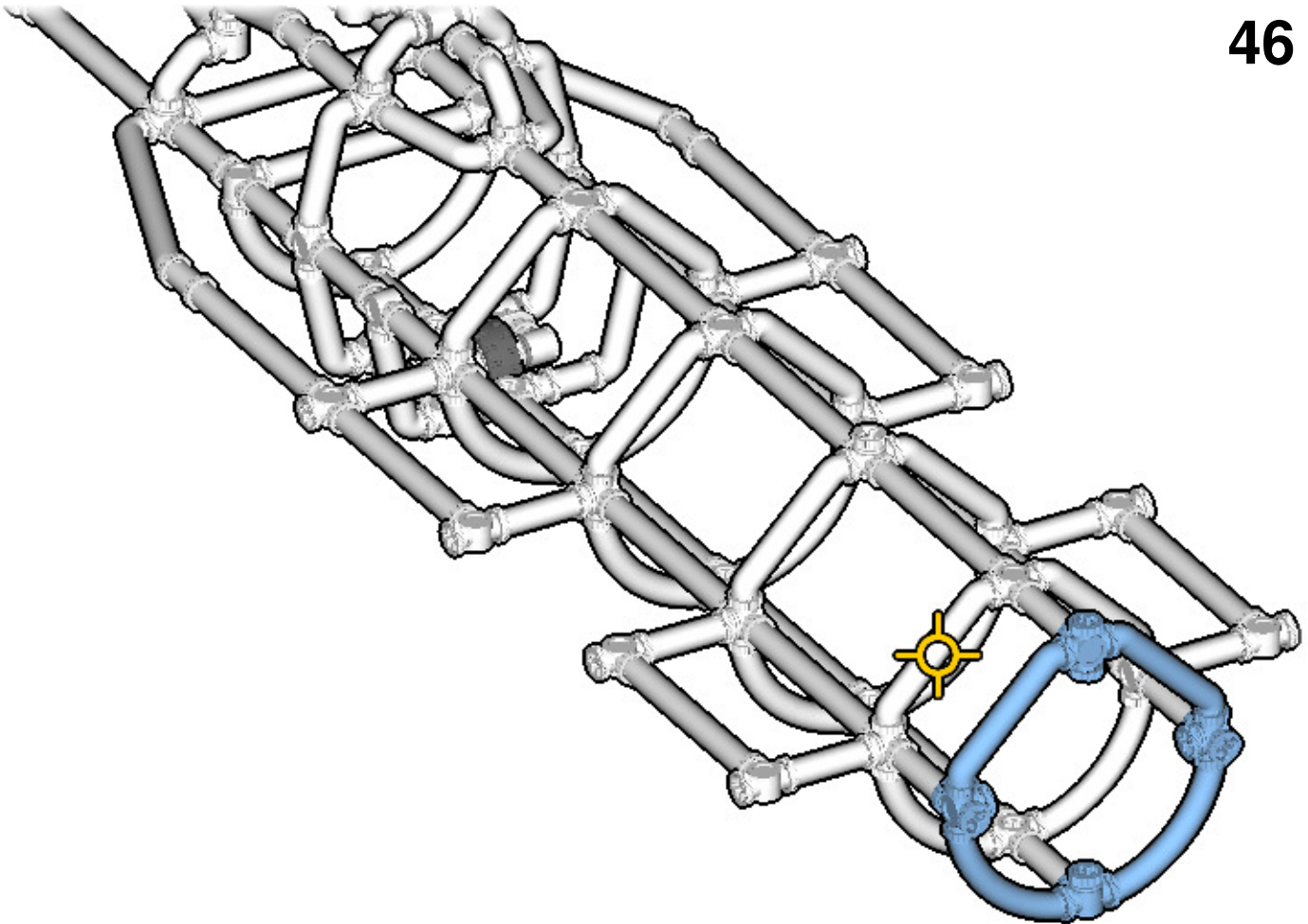

47

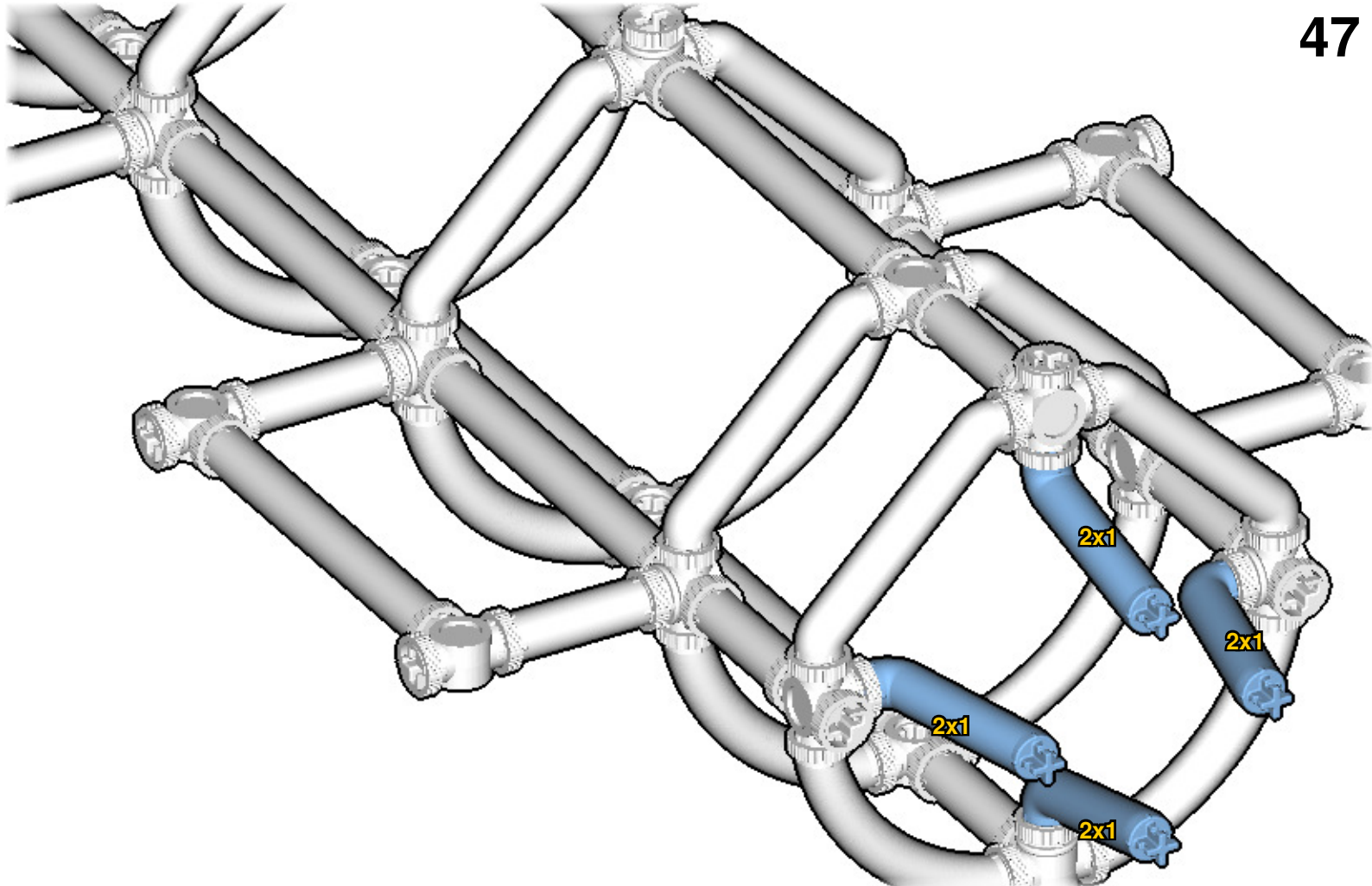

48

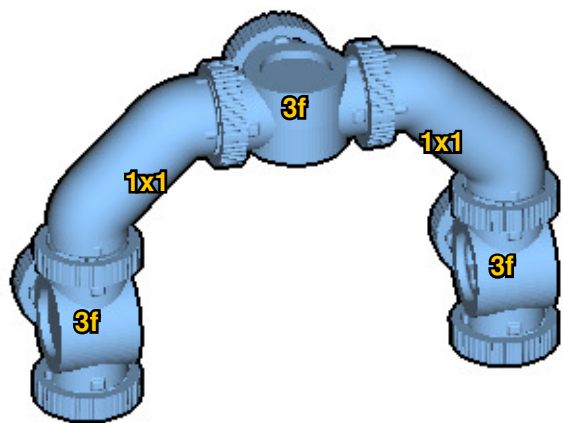

49

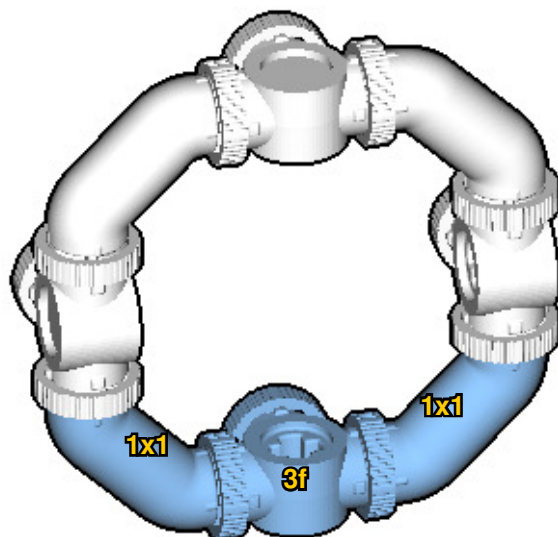

50

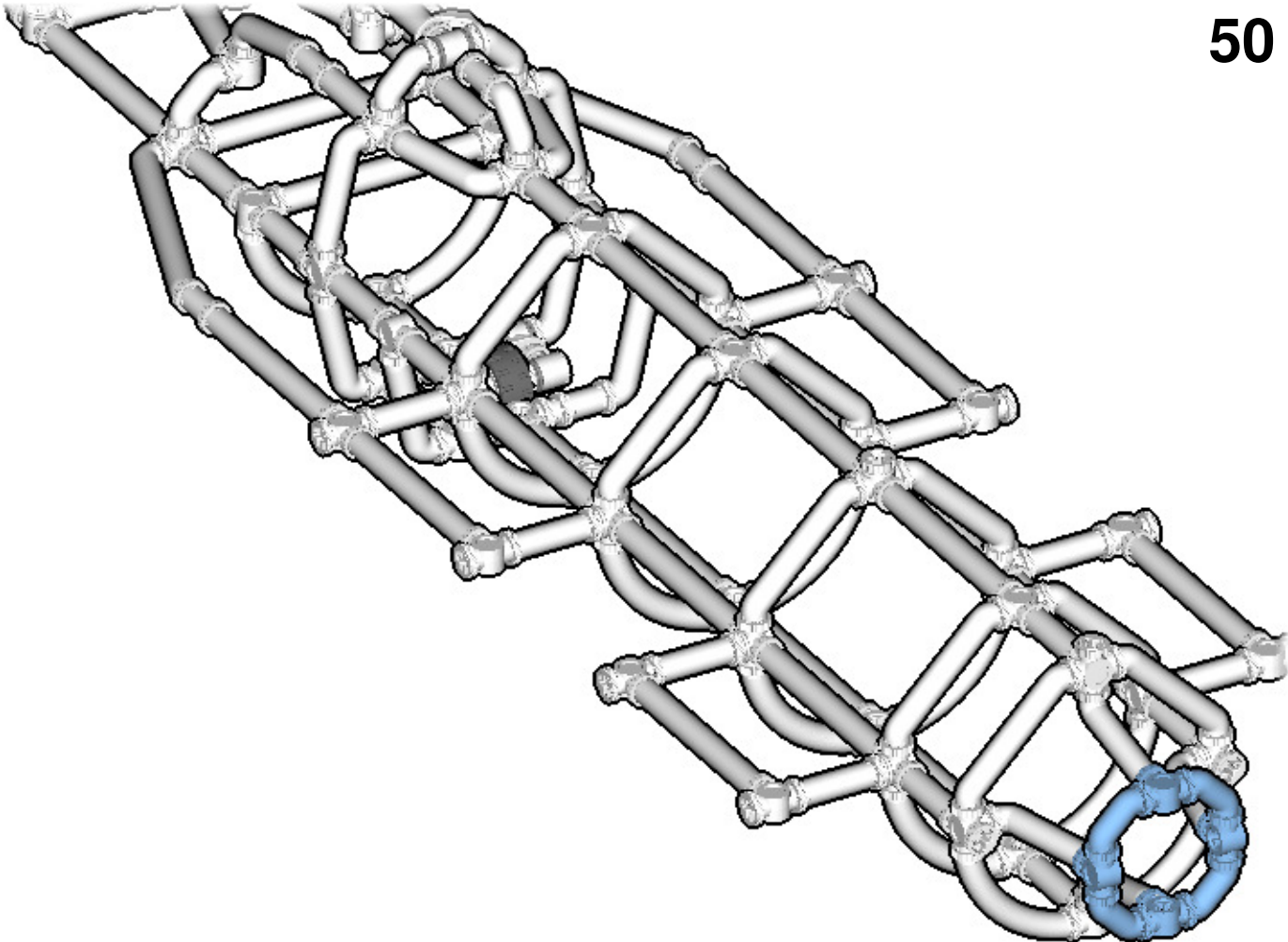

51

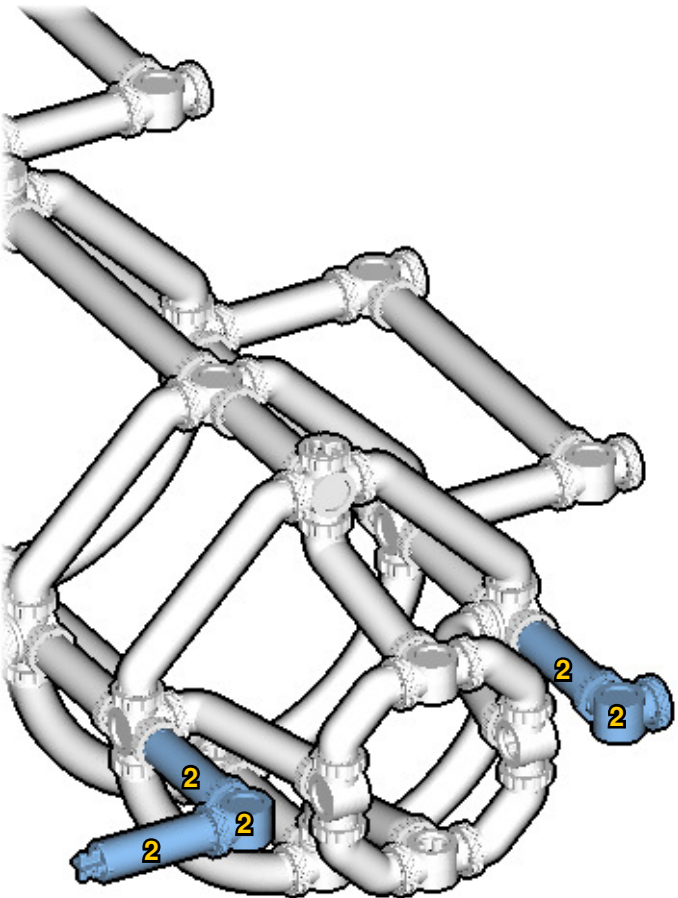

52

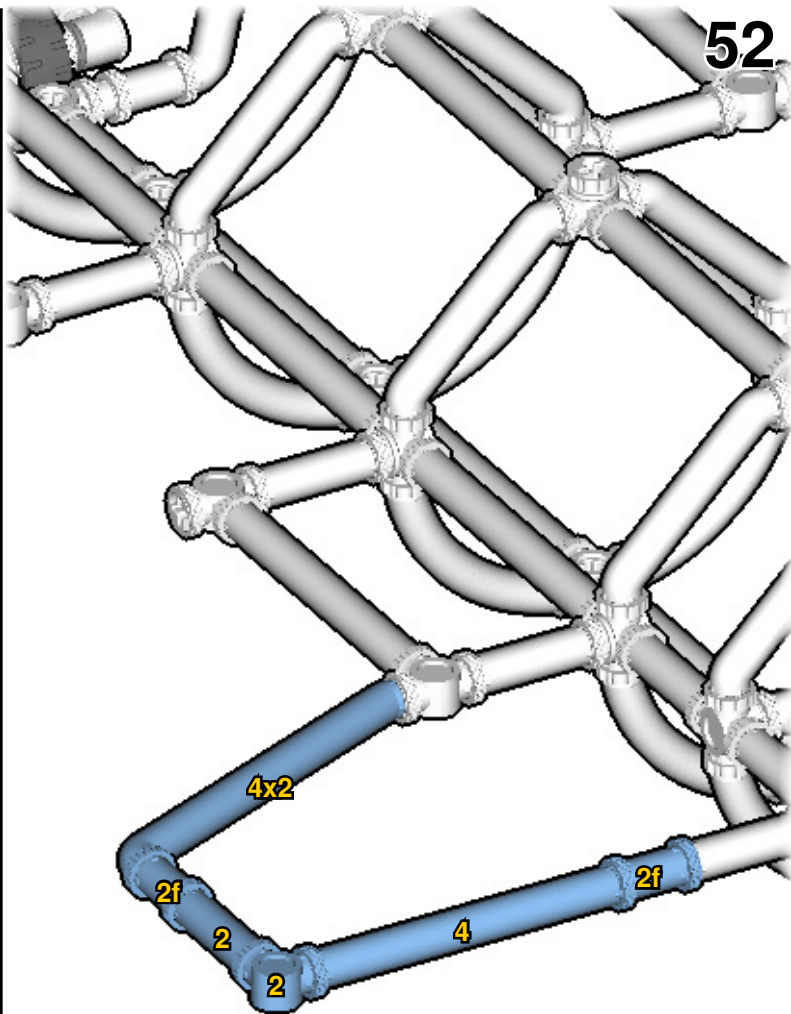

53

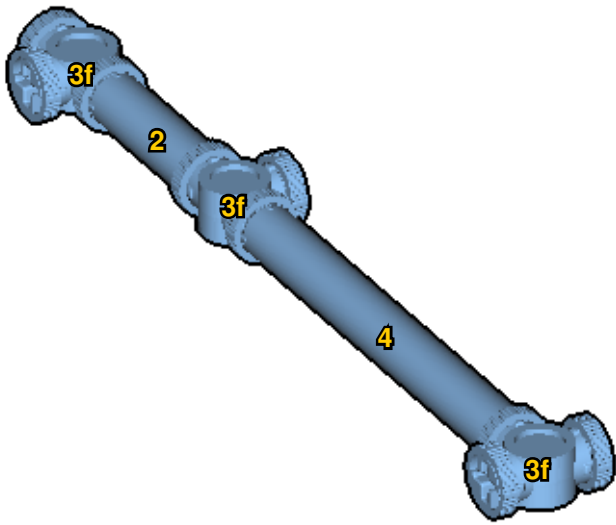

54

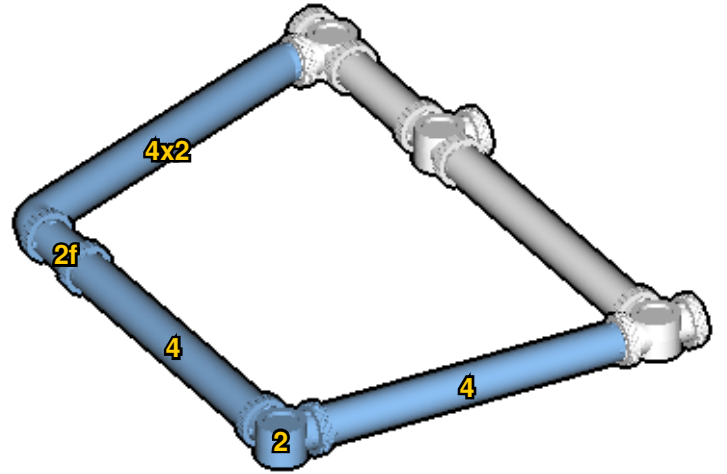

55

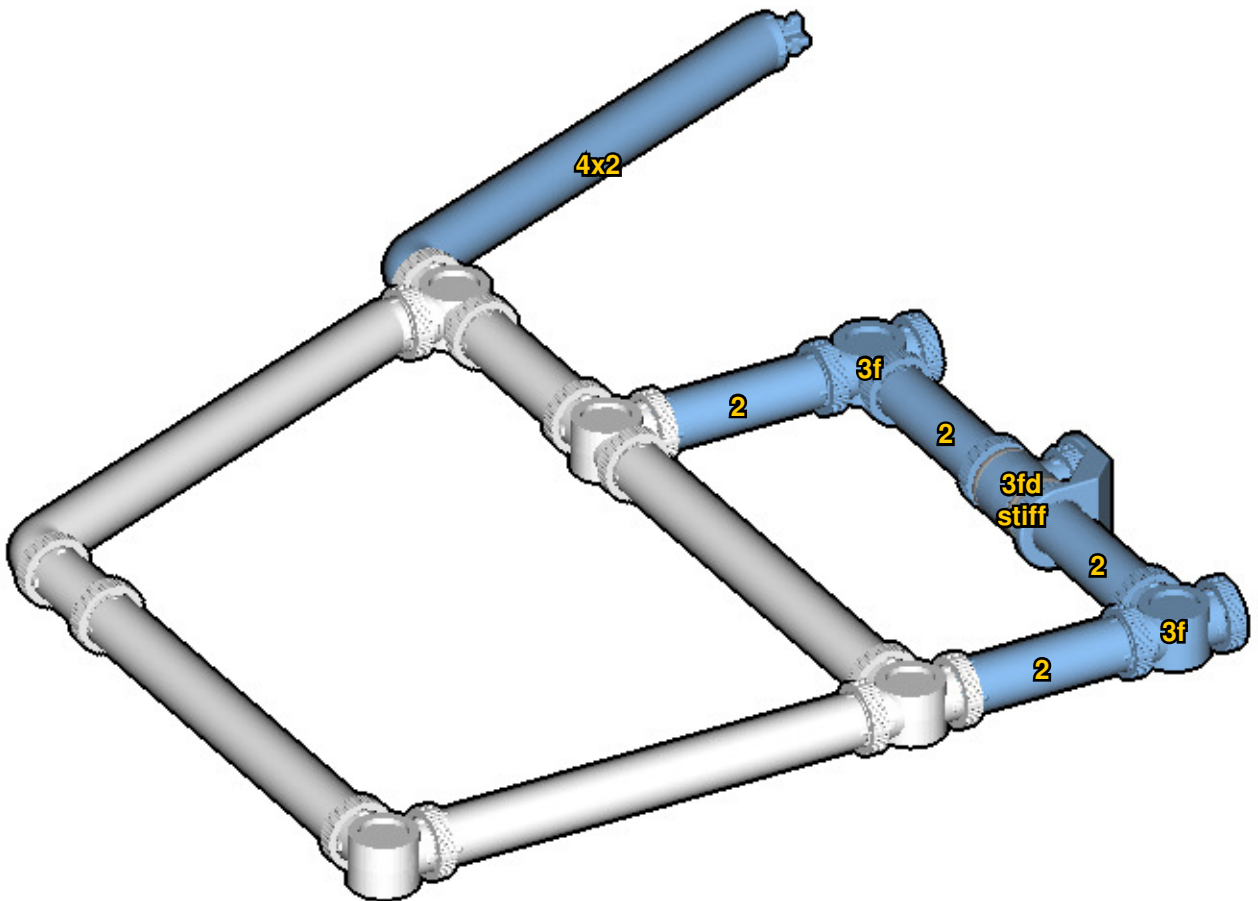

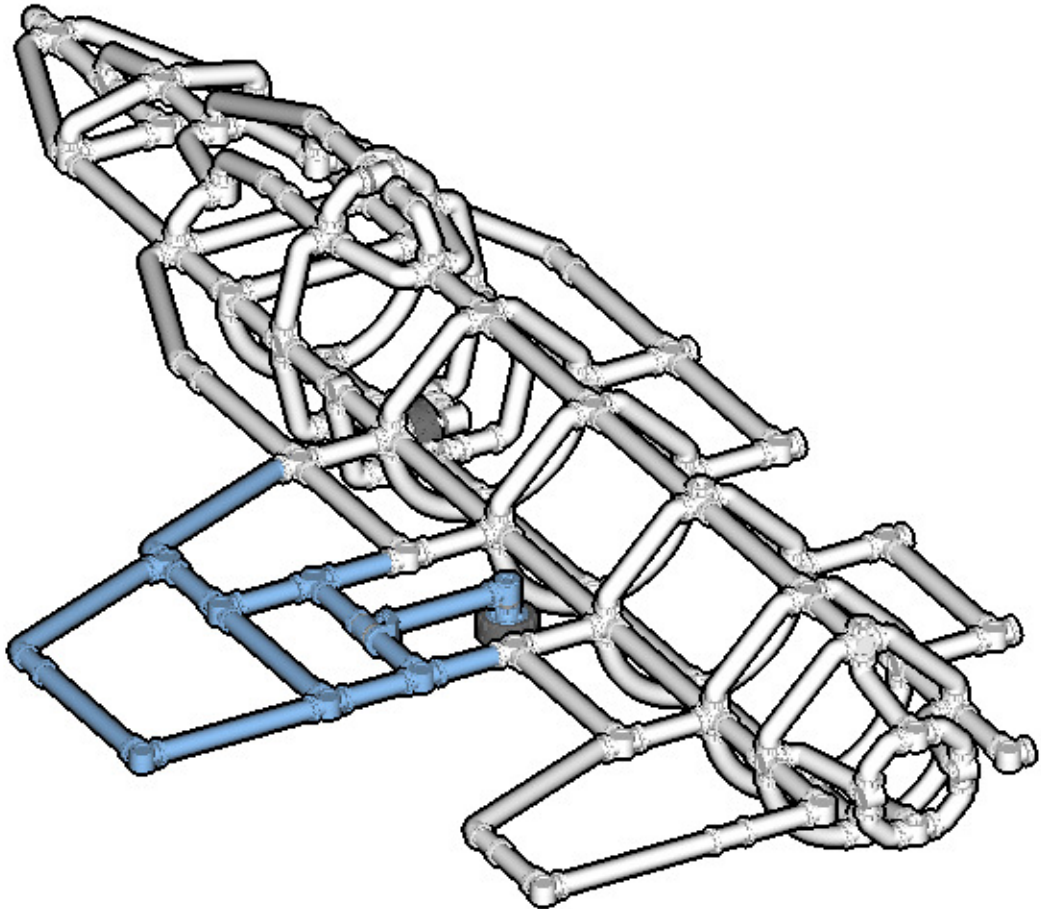
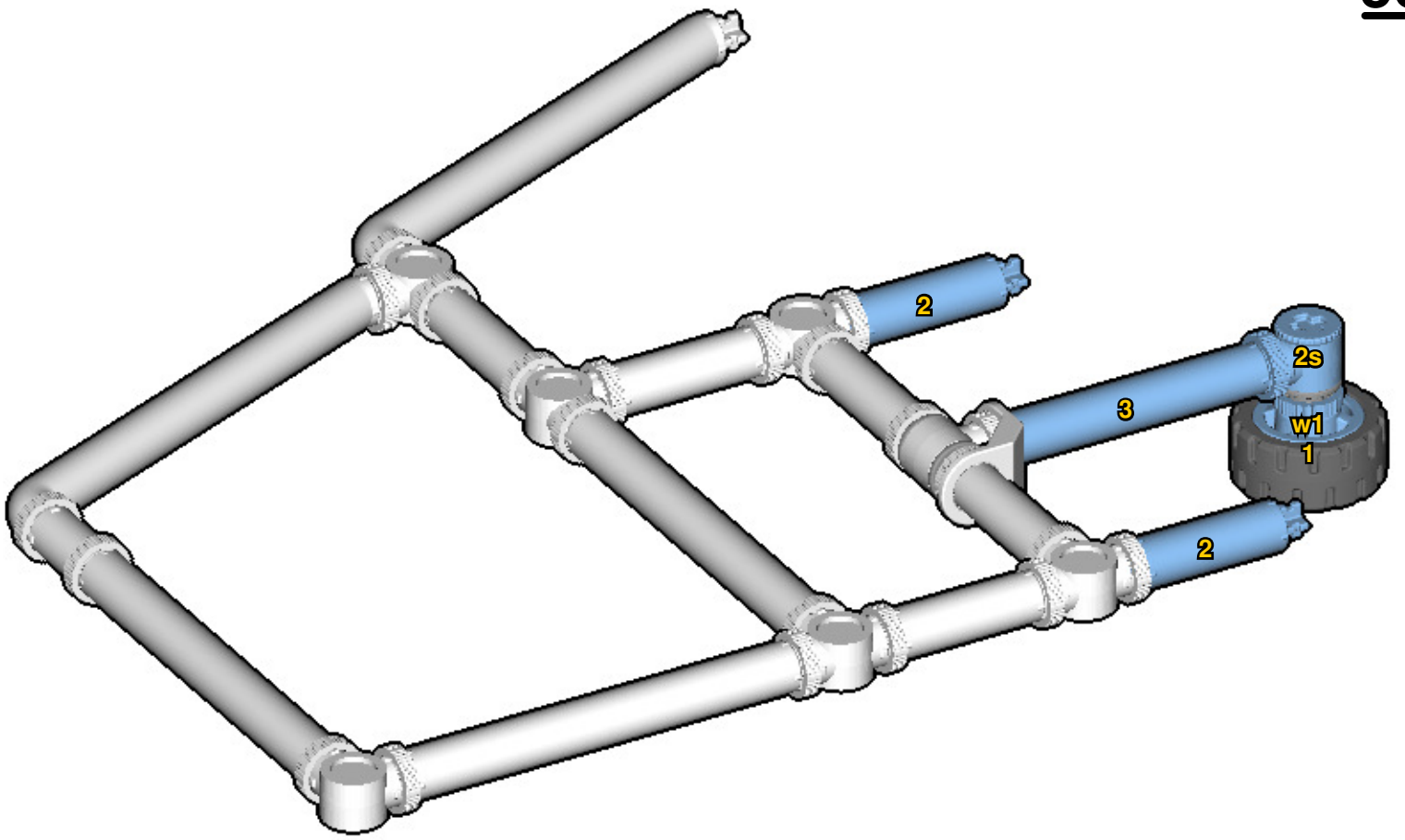

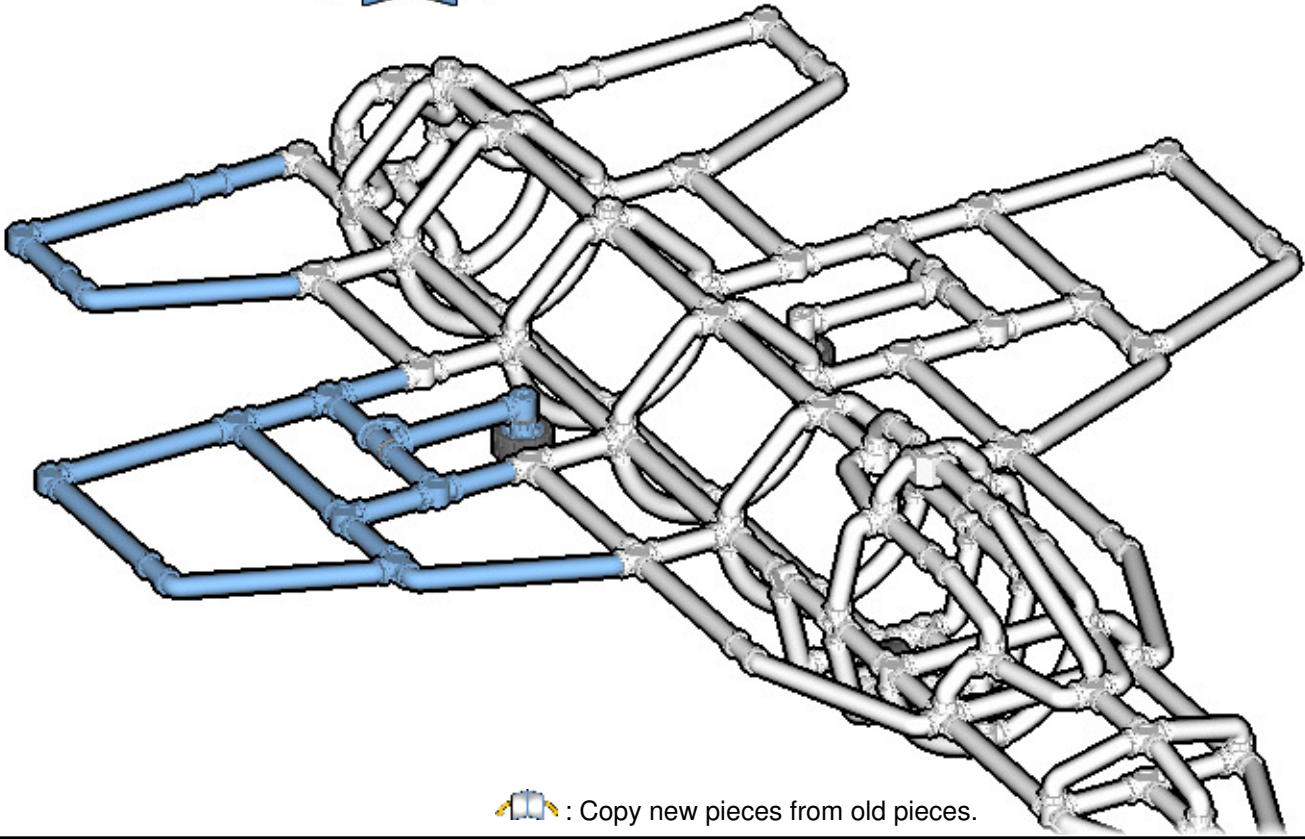

 : Copy new pieces from old pieces.

59

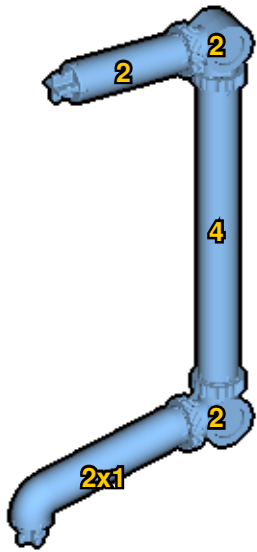

60

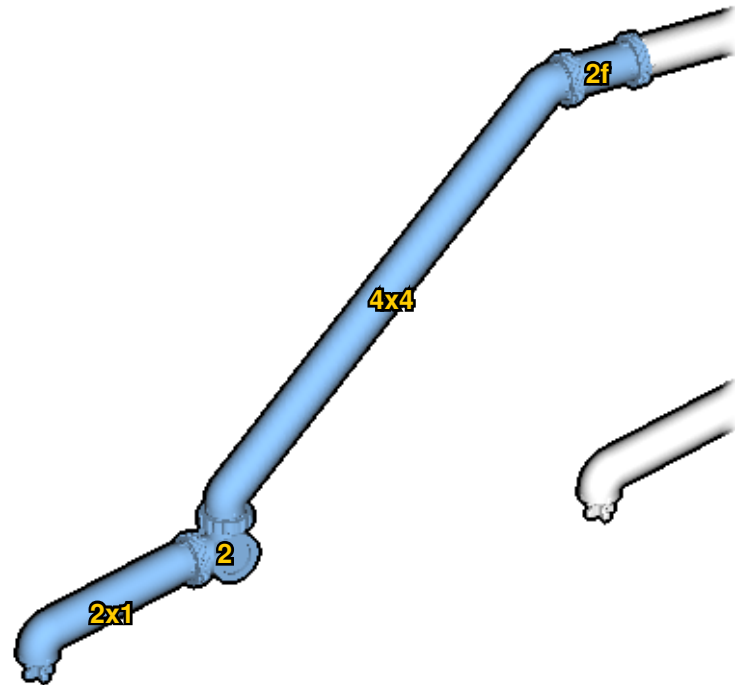



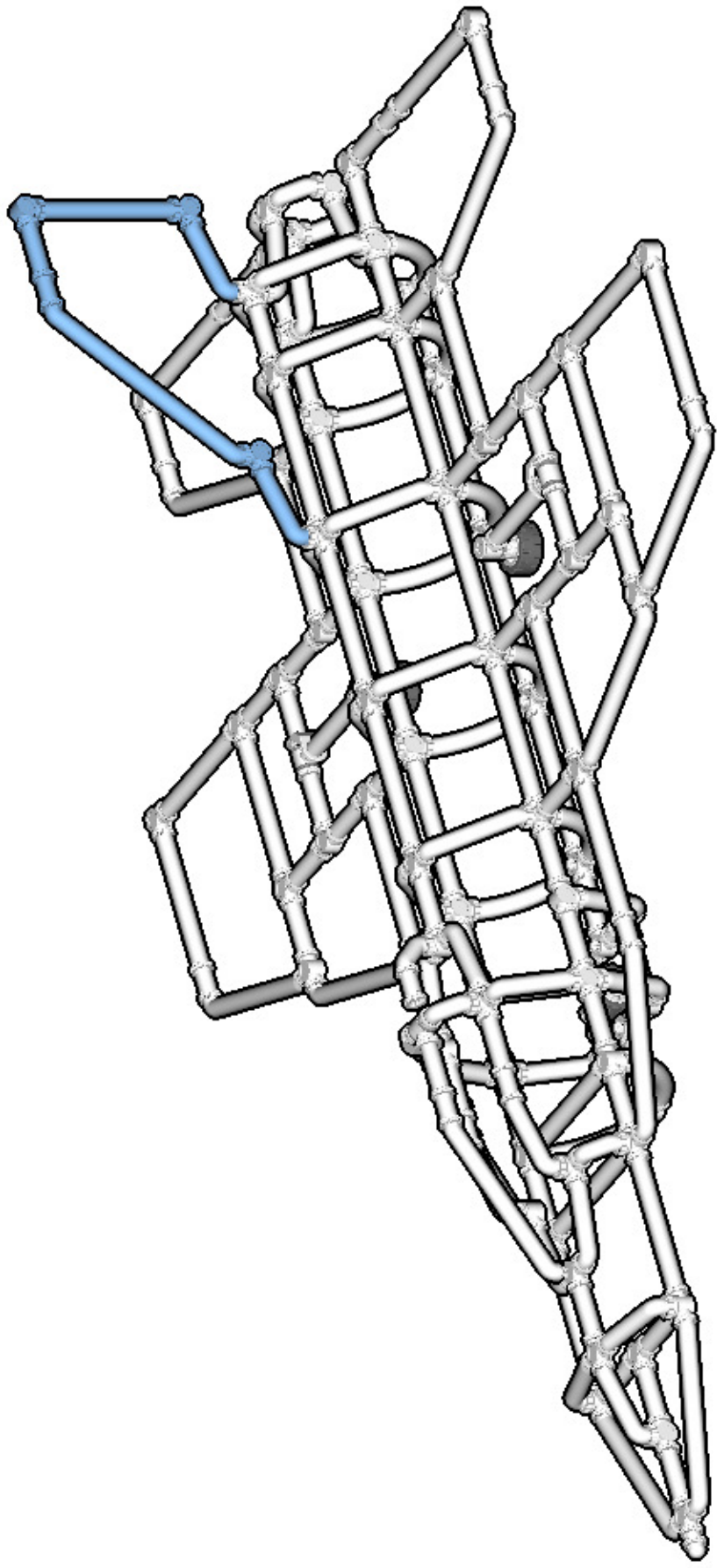

# INVENTORY

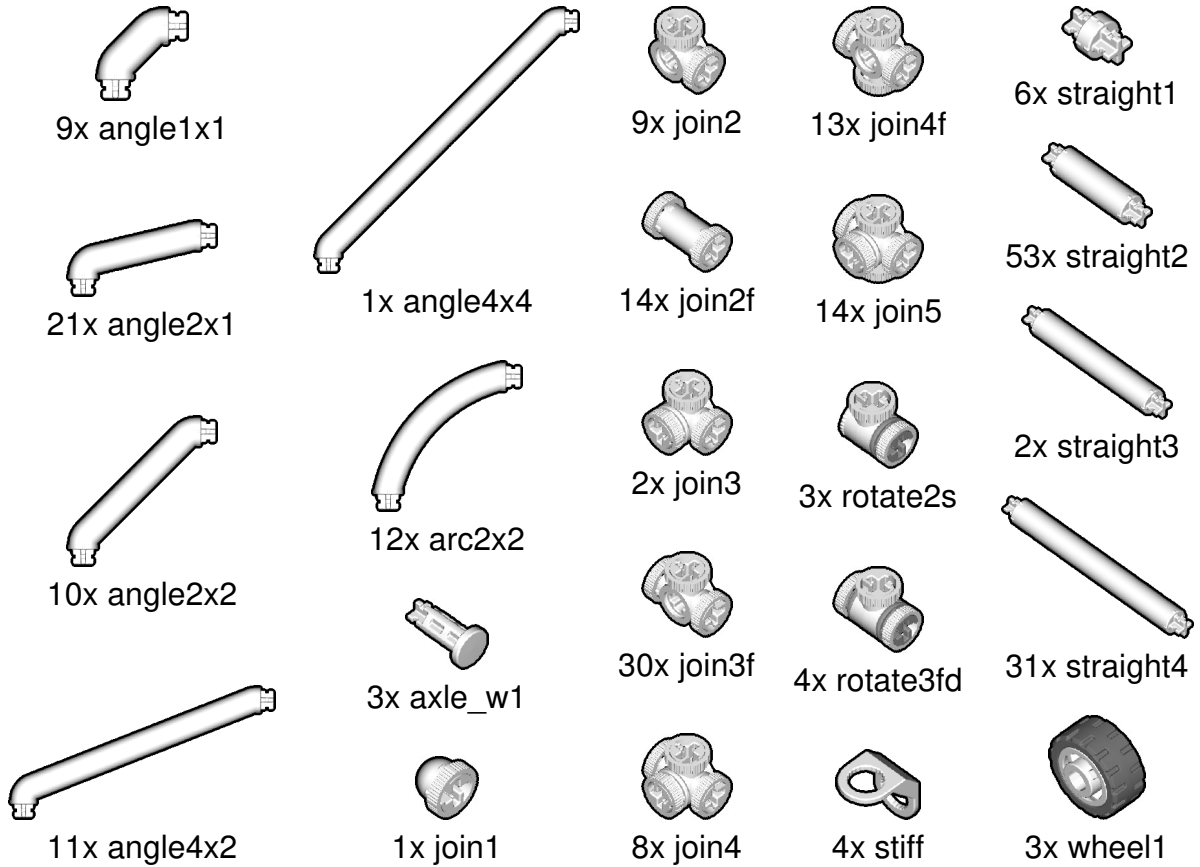

# ACTUAL SIZE

