

SIZE	3.2ft x 0.7ft x 0.4ft	PIECES	340
DESIGNER	Derek Sharman	MADE IN	U.S.A.

NAUTILUS

⚠ WARNING: Small parts. Age 14+. Not a toy. Handle responsibly. U.S. Patent 9,086,087.



Wrong
Connecting/Disconnecting Two Directions



Right
Connecting/Disconnecting One Direction

1

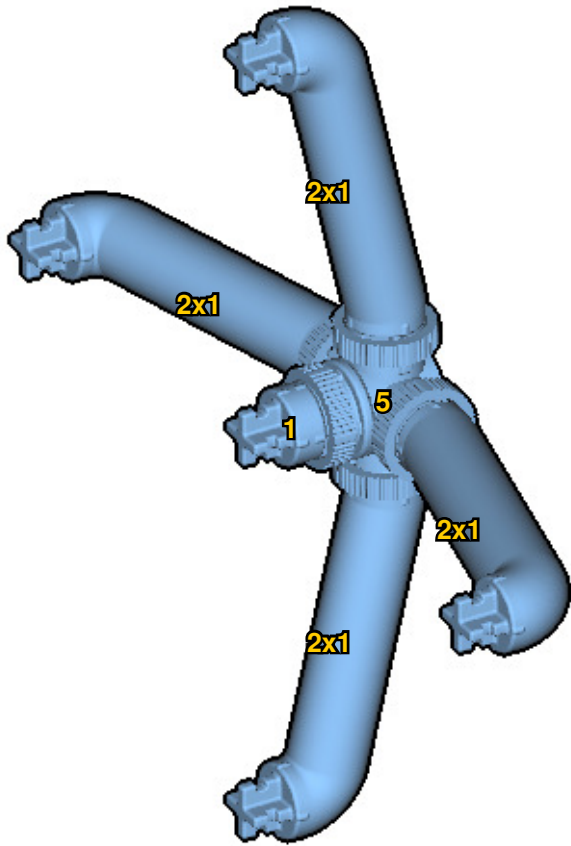

New pieces are drawn blue. Old pieces are drawn white.
See back for piece names.

2

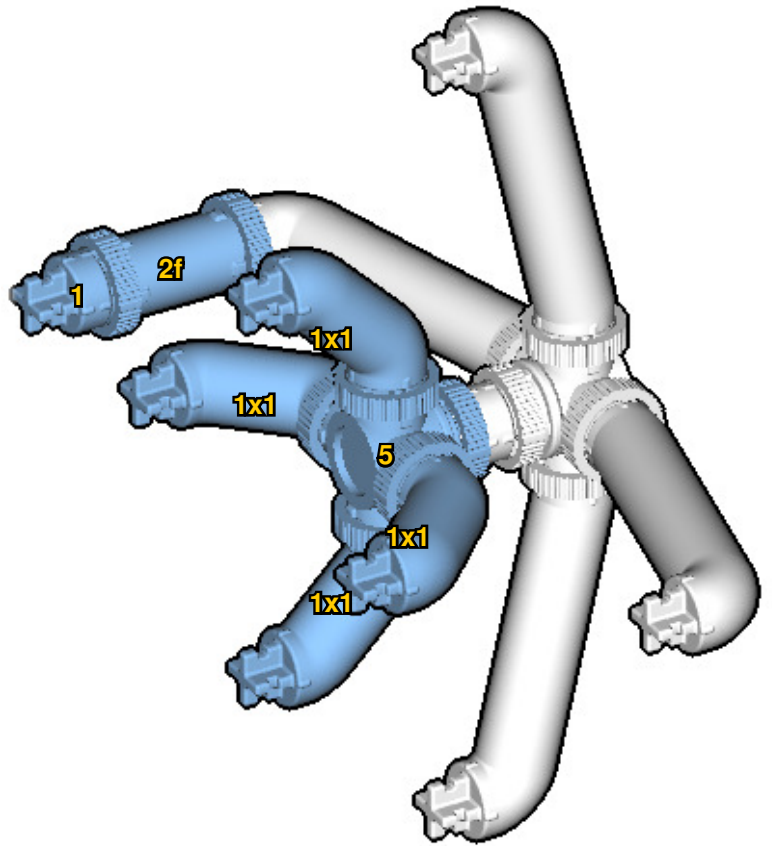

Connect new pieces together before connecting to old pieces.

3

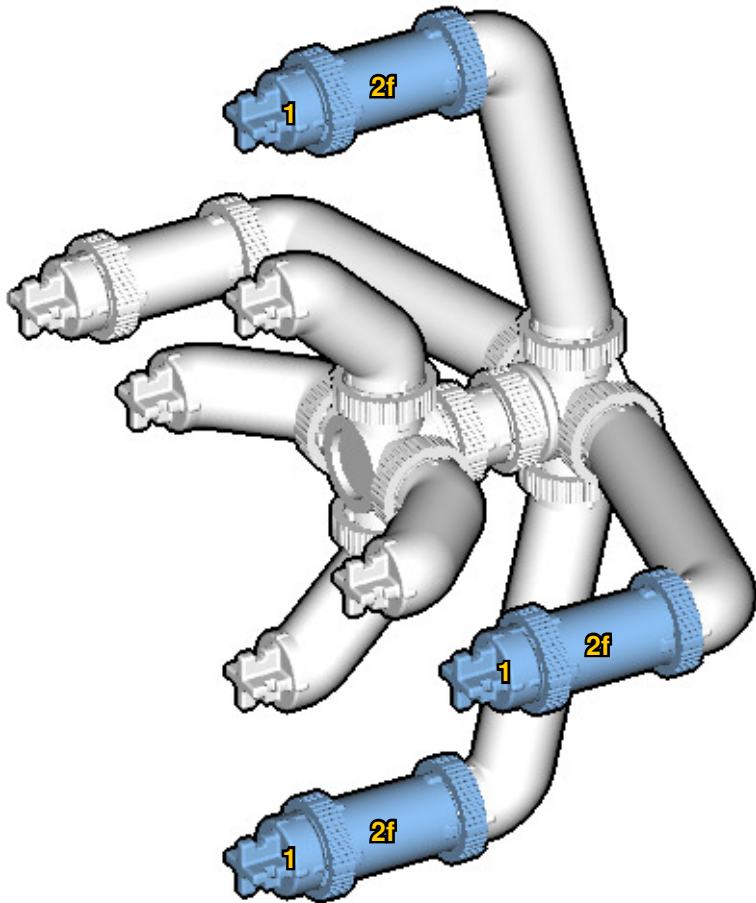

Submodel begins → **4**

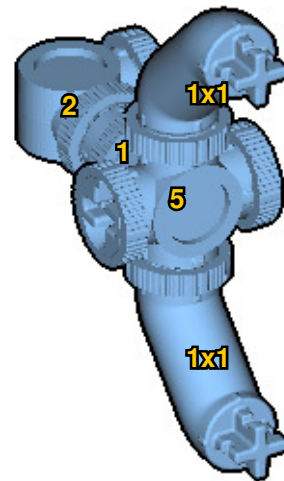

5

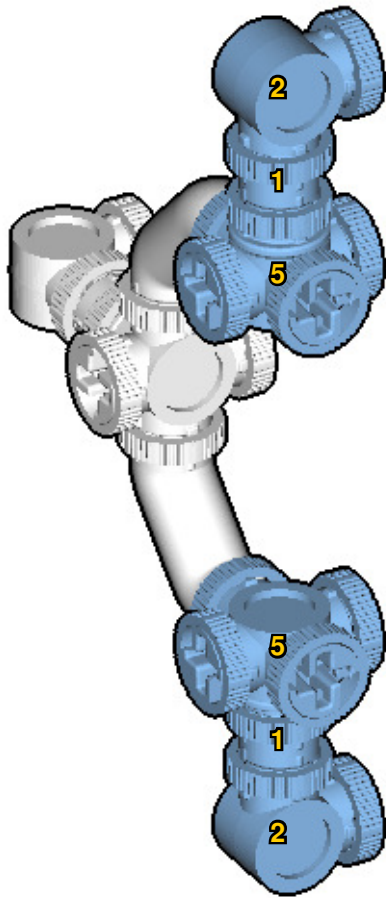

6

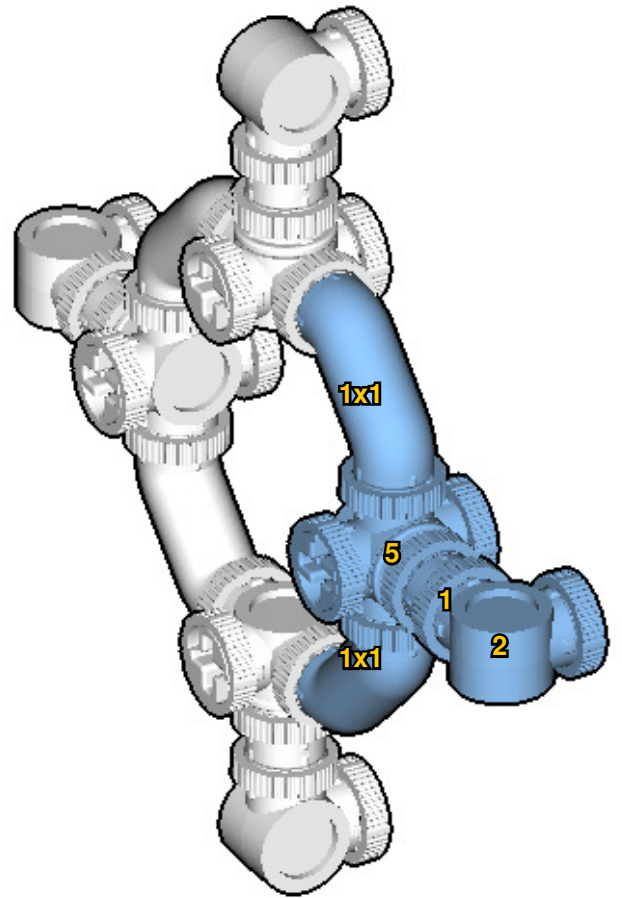

7

Submodel ends →

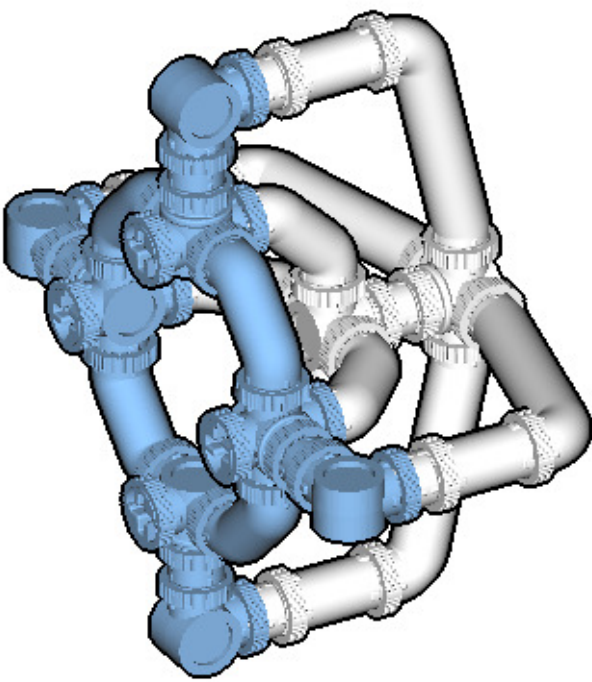

8

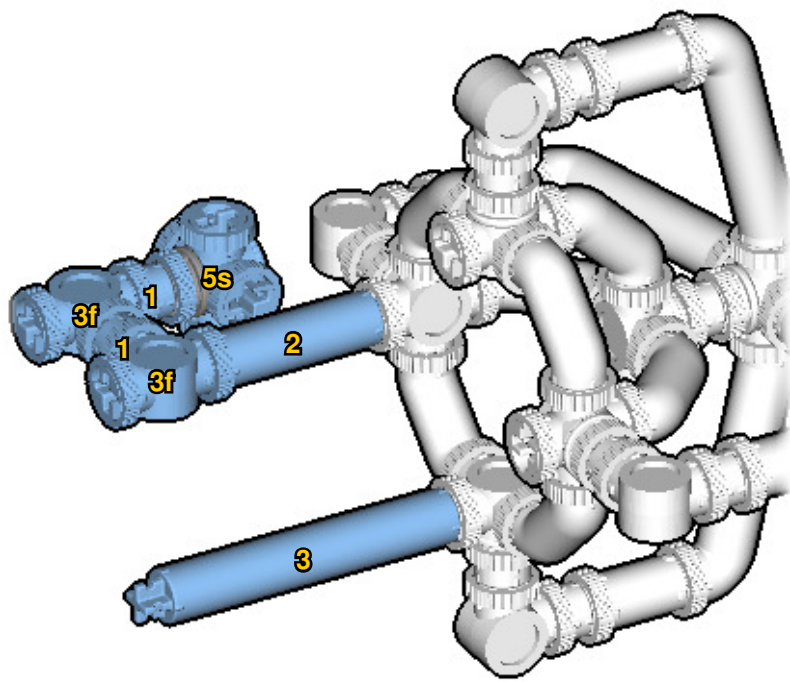

Connect submodel to model.

9

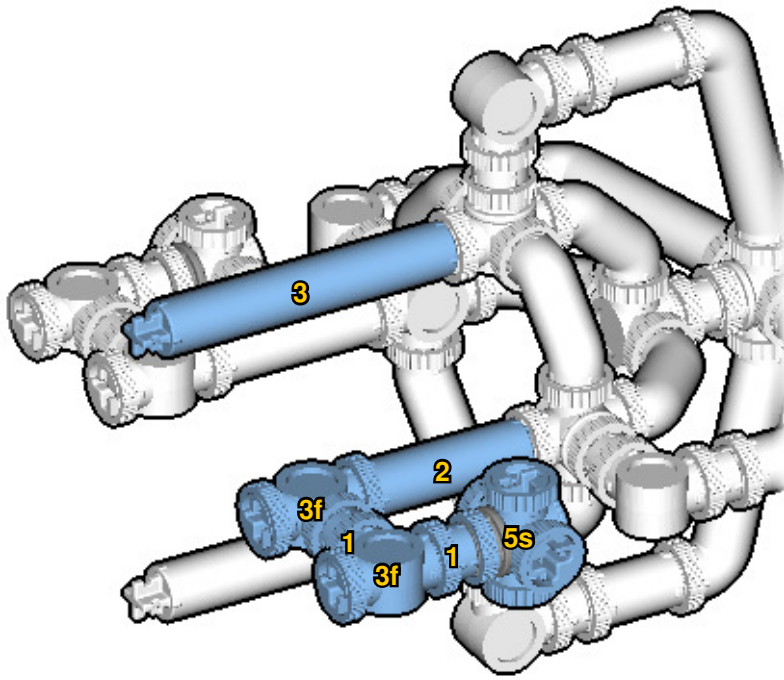

10

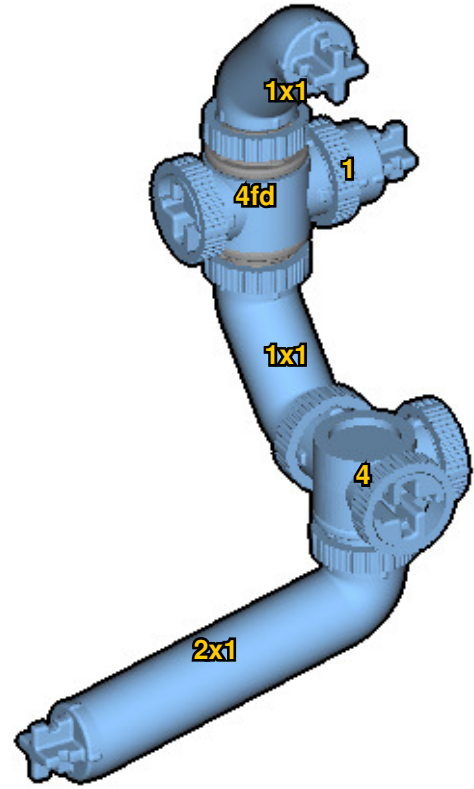

11

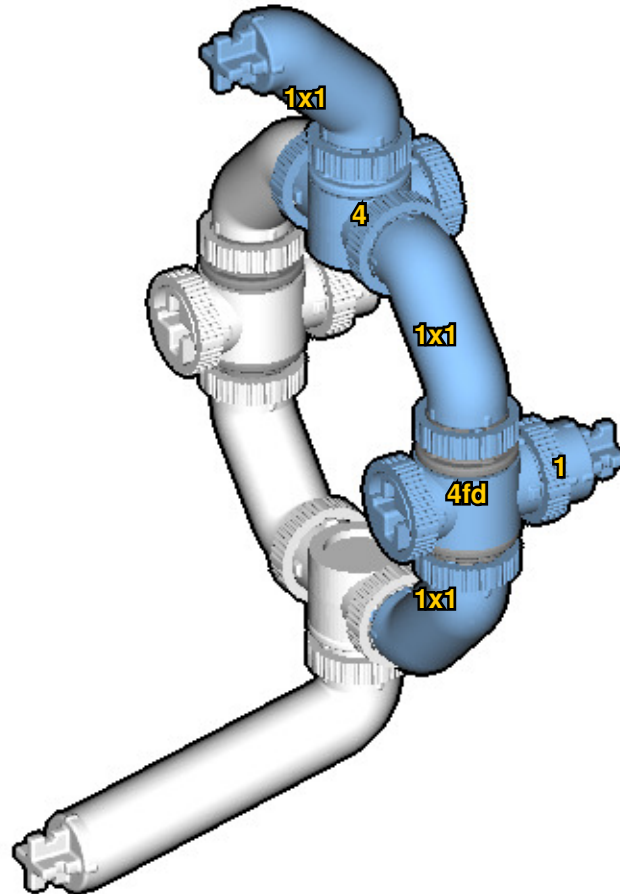

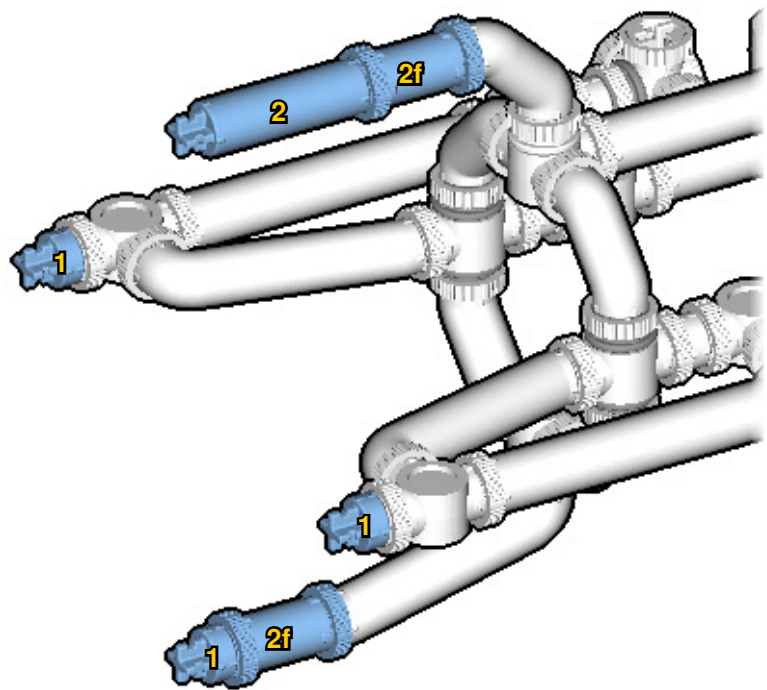
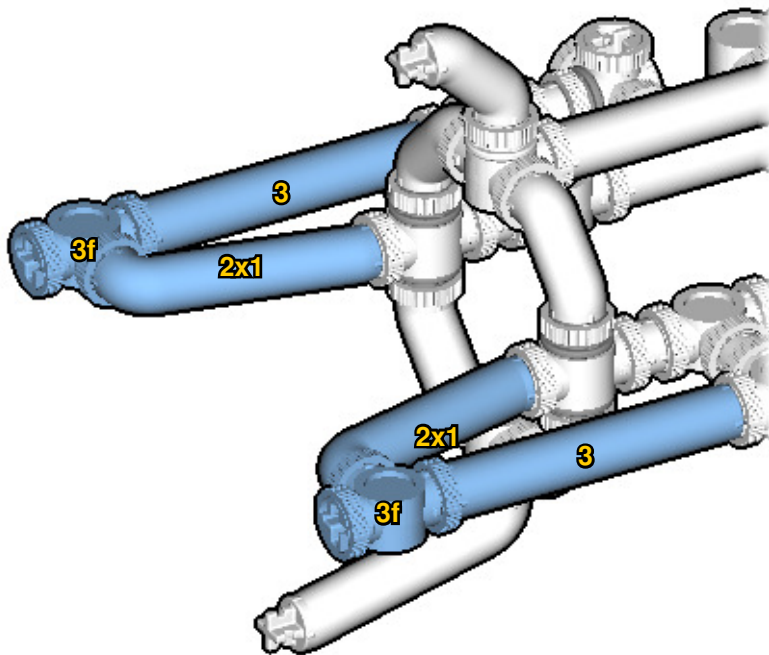
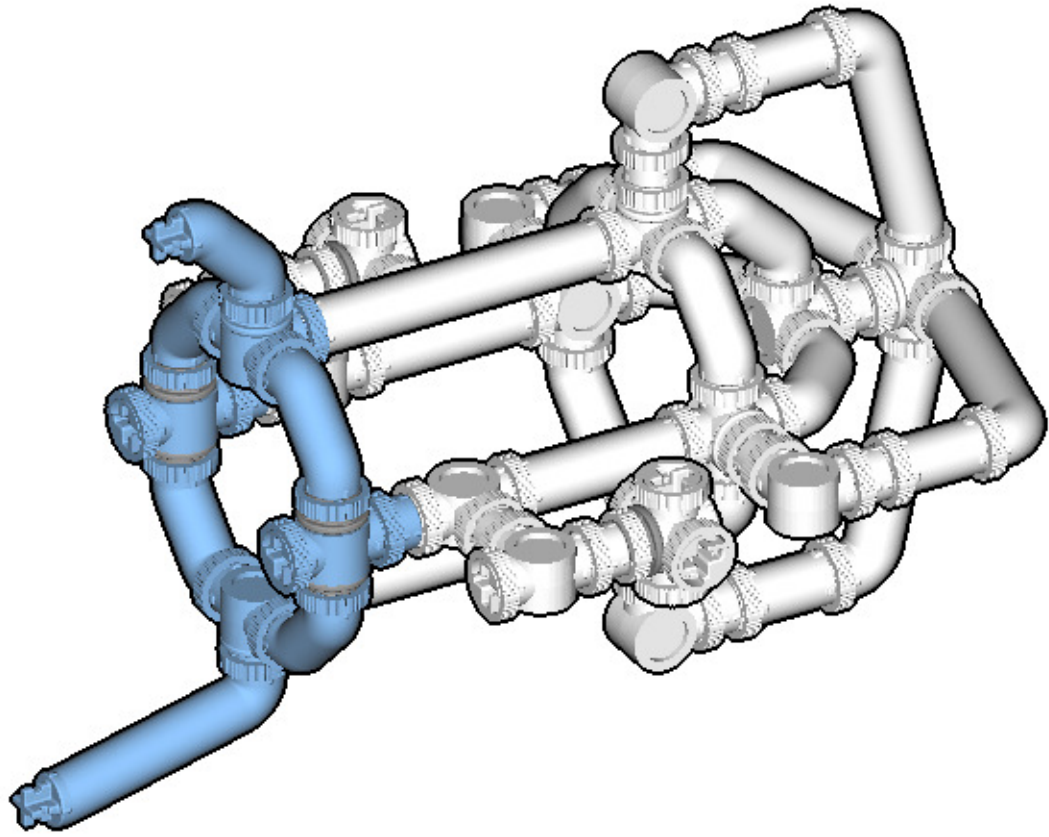

15

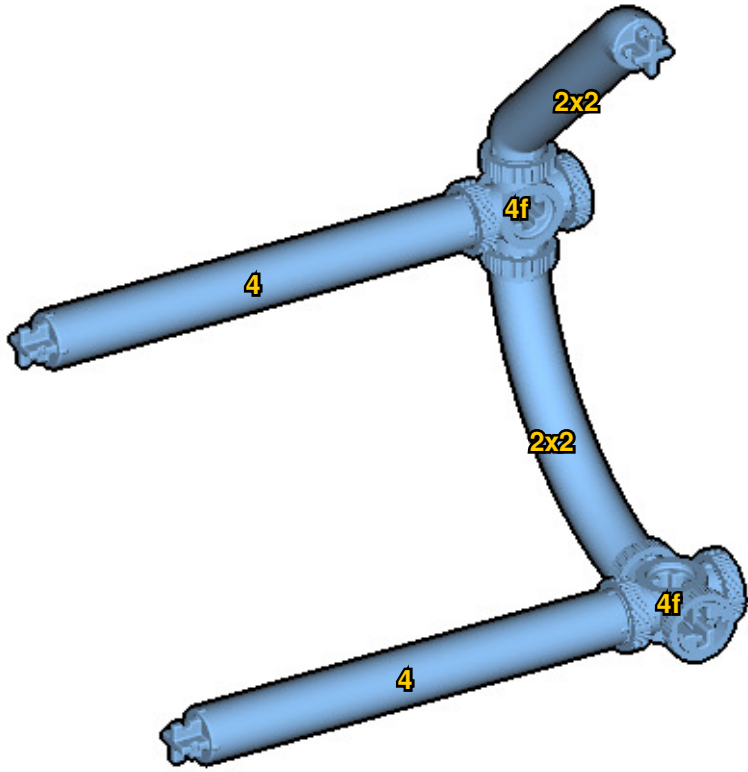

16

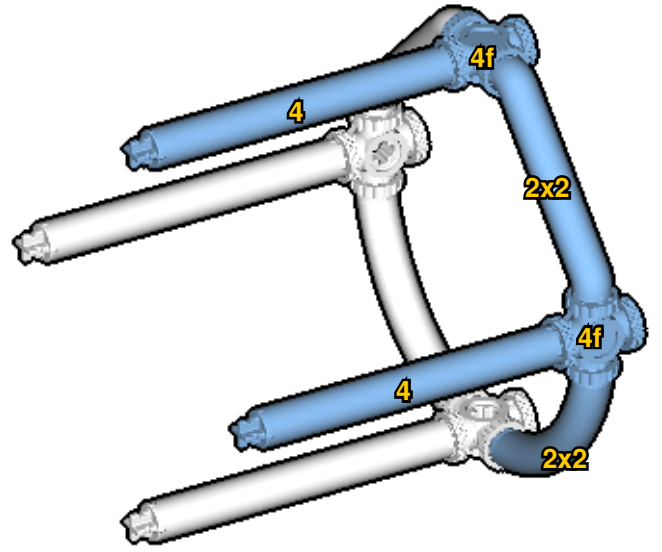

17

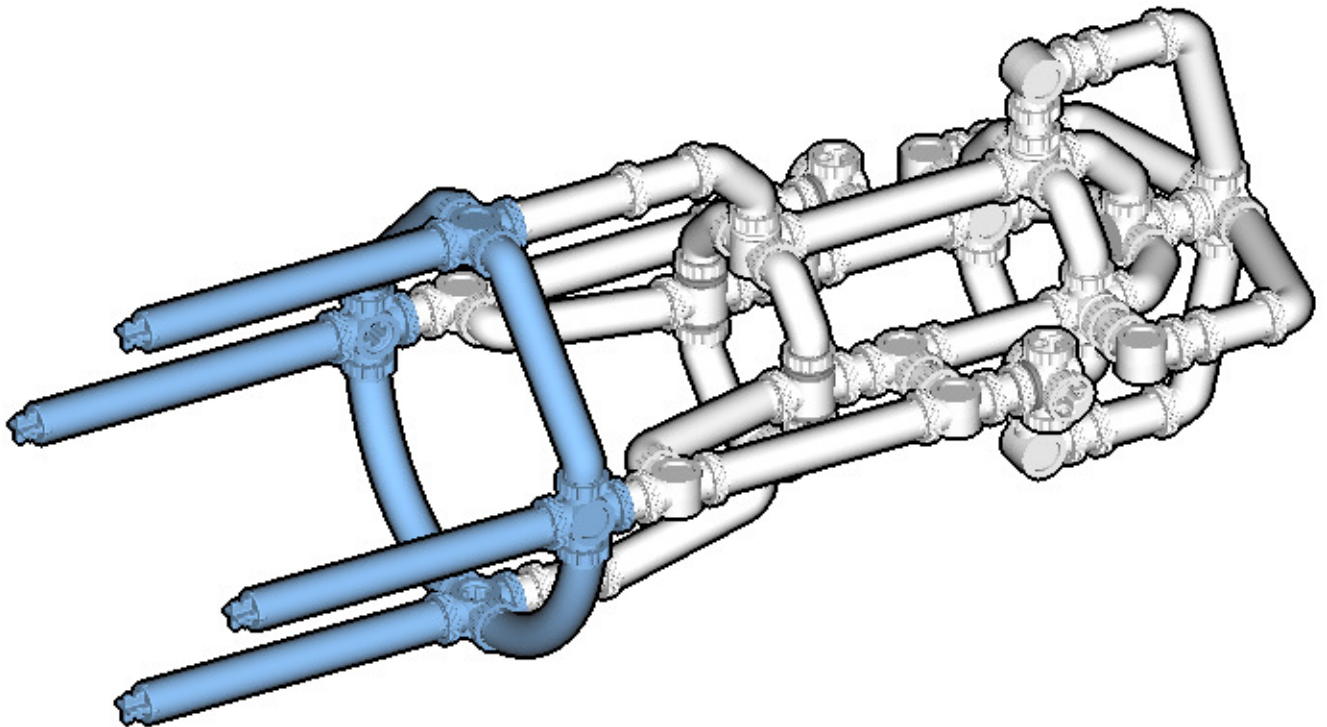

18

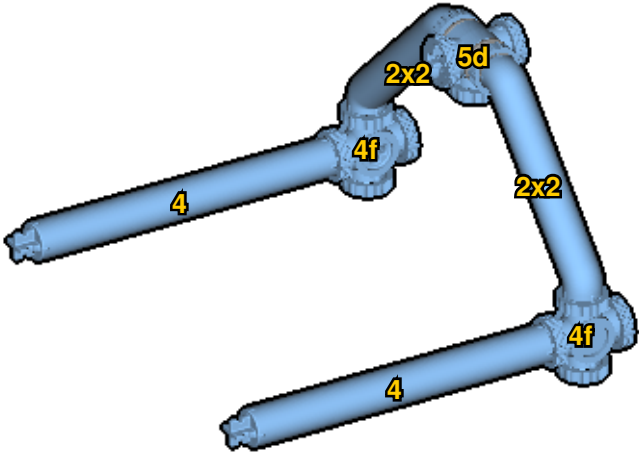

19

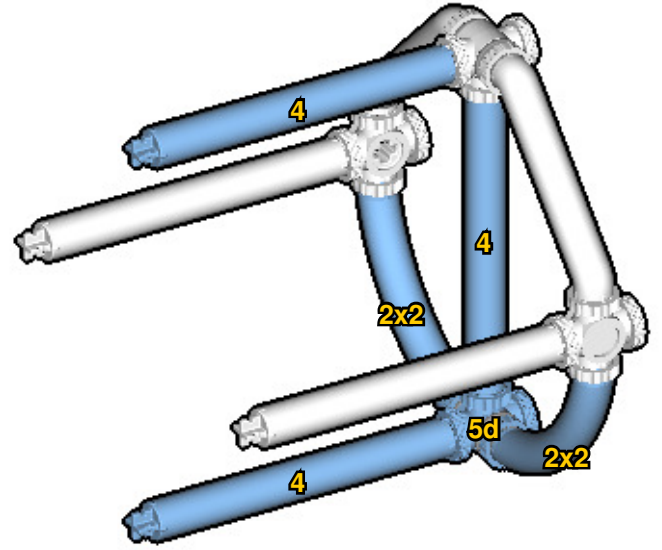

20

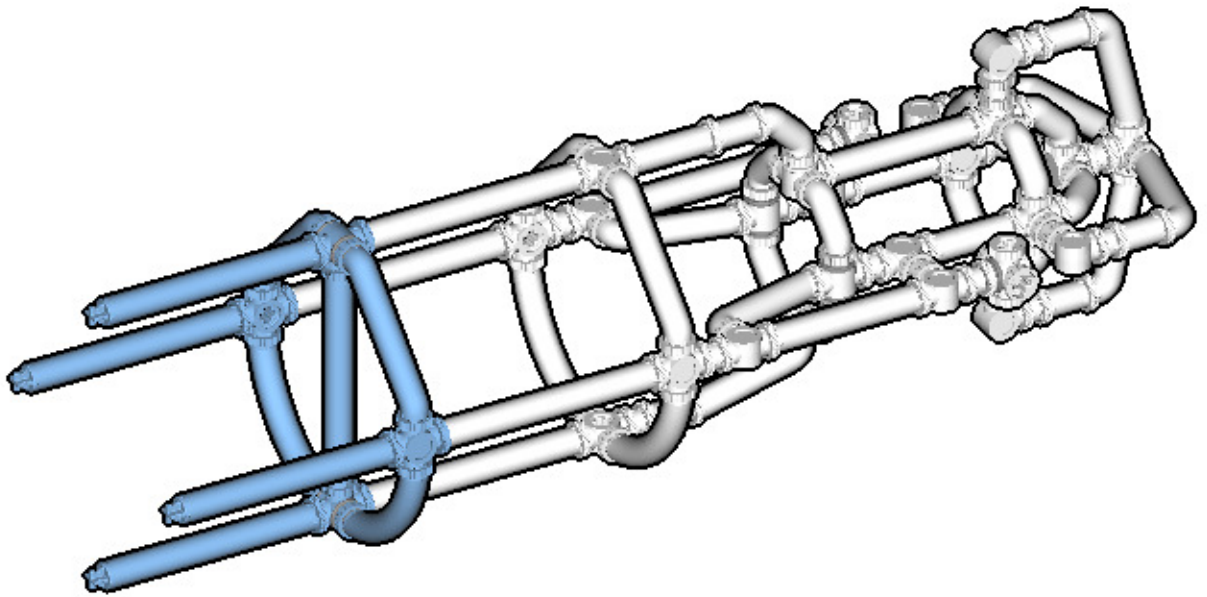

21

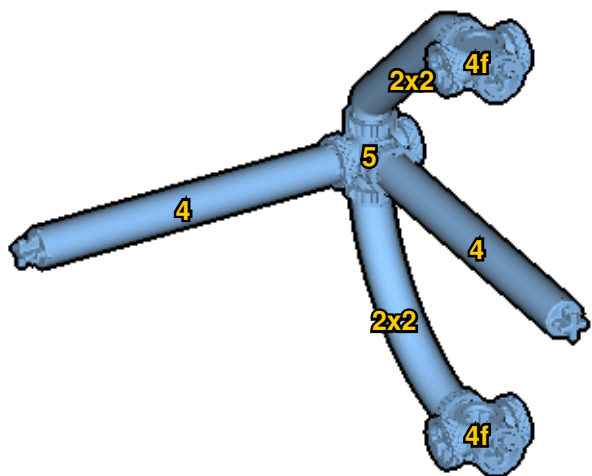

22

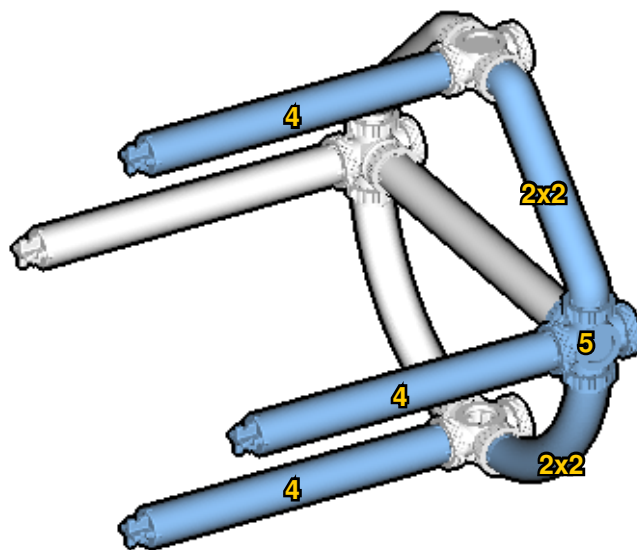

23

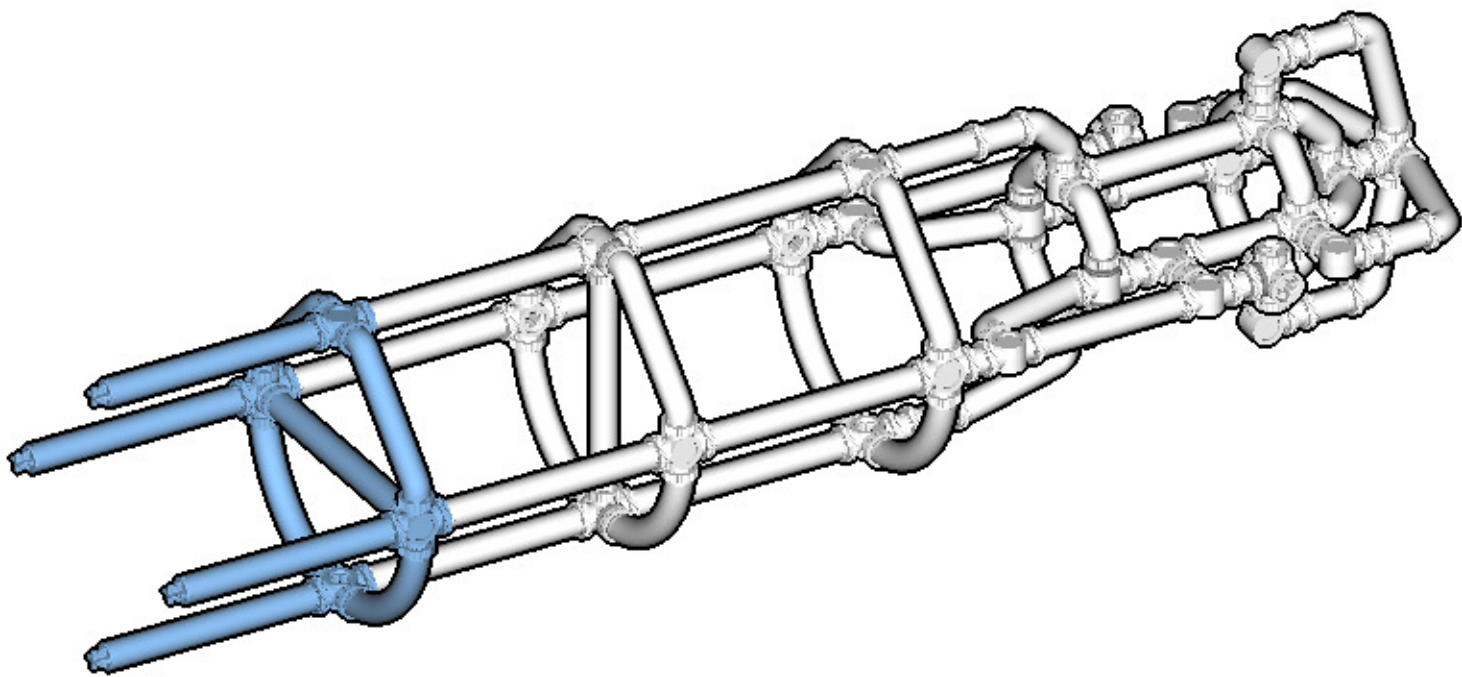

24

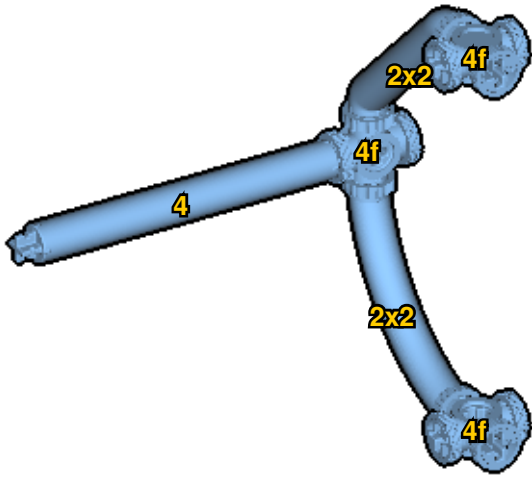

25

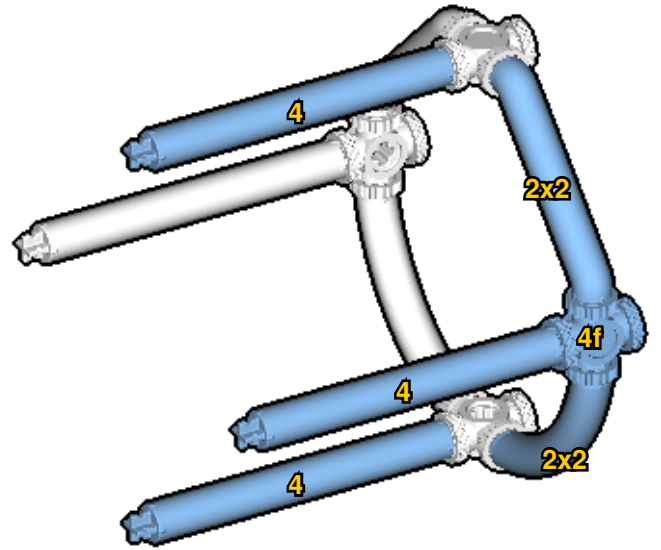

26

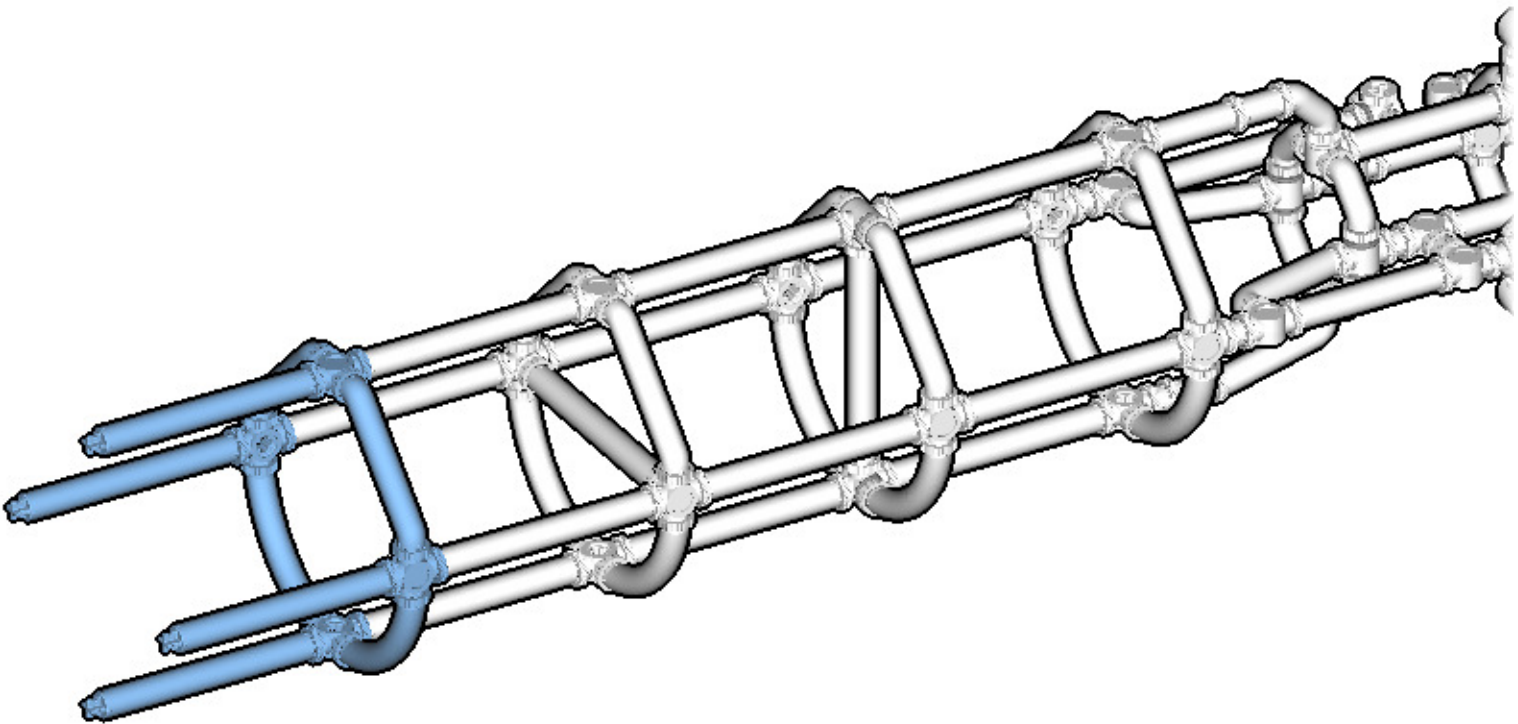

27

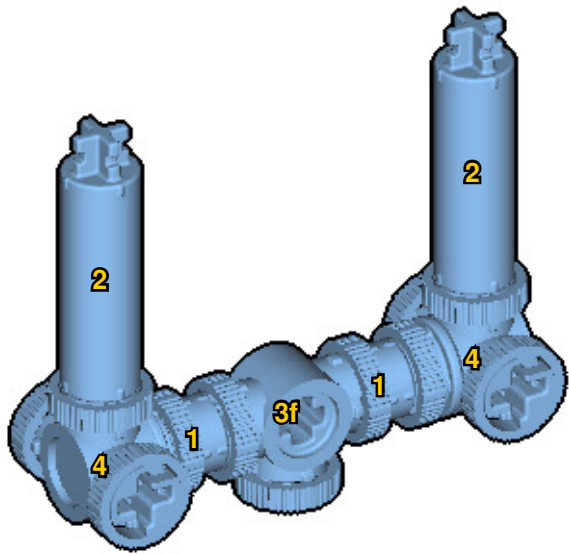

28

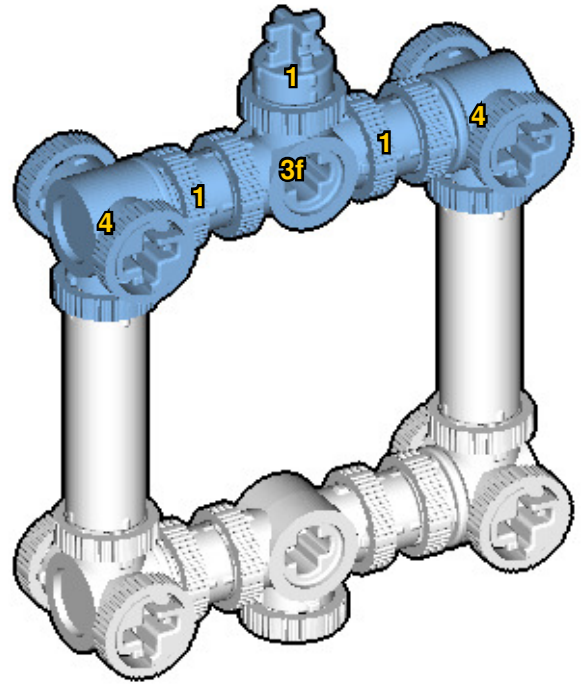

29

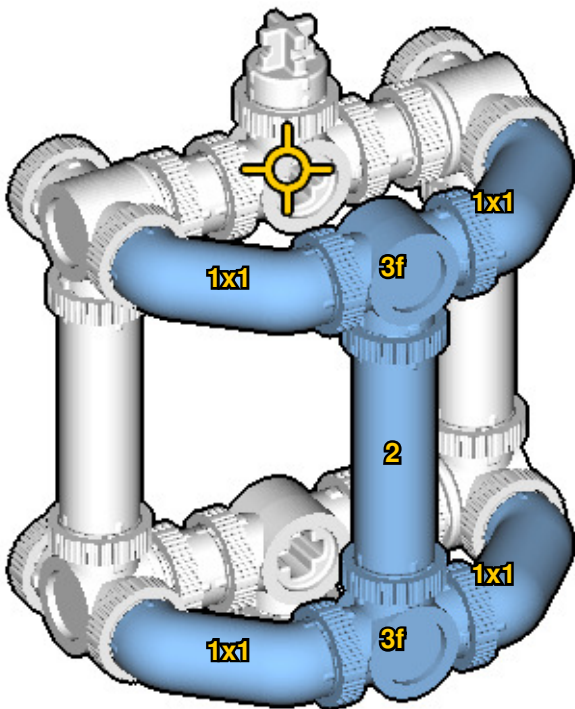

30

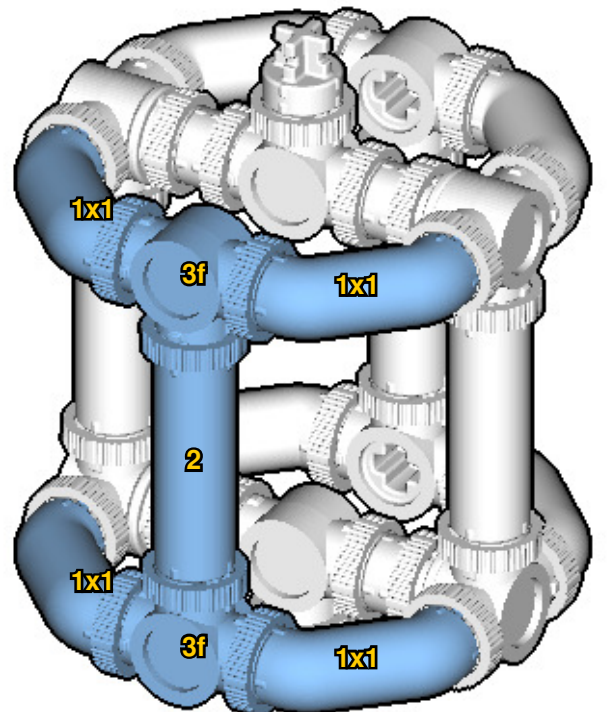

✚ : The next frame is centered on this piece.

31

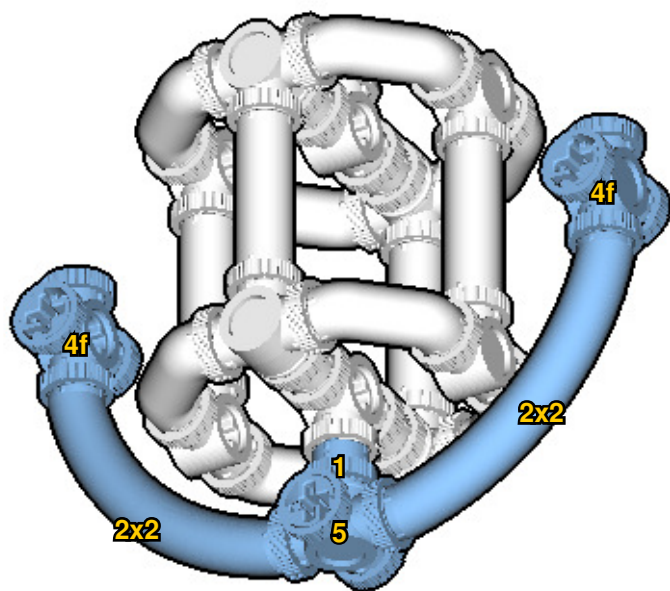

32

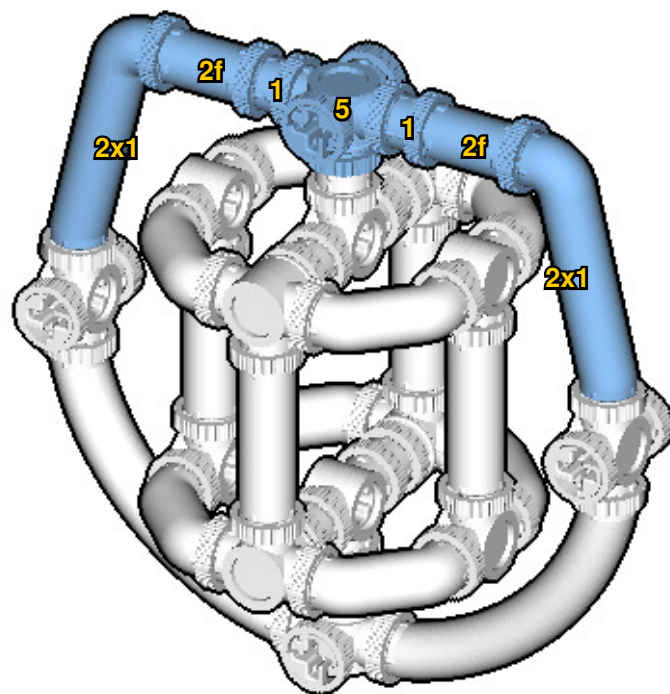

33

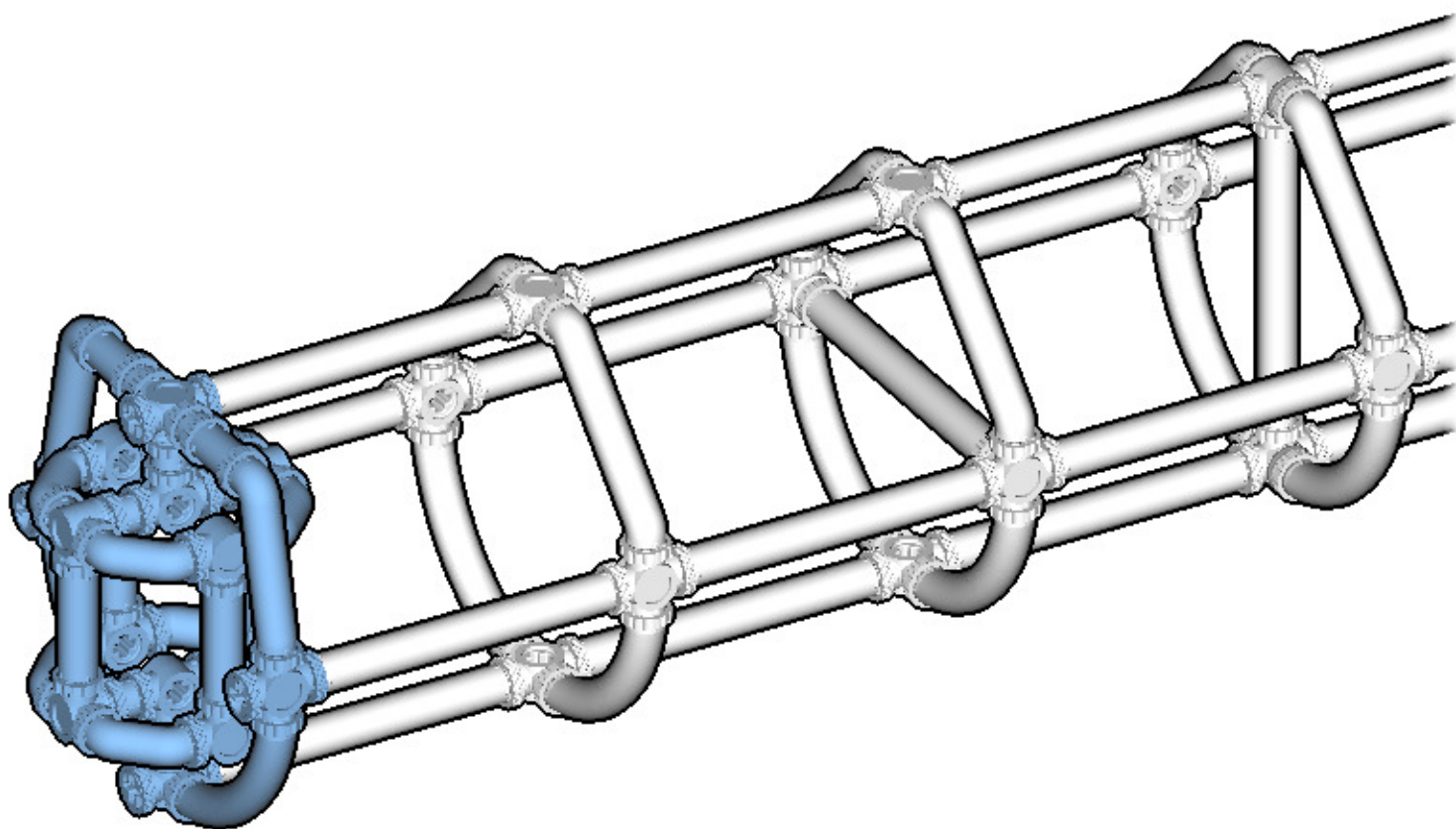

34

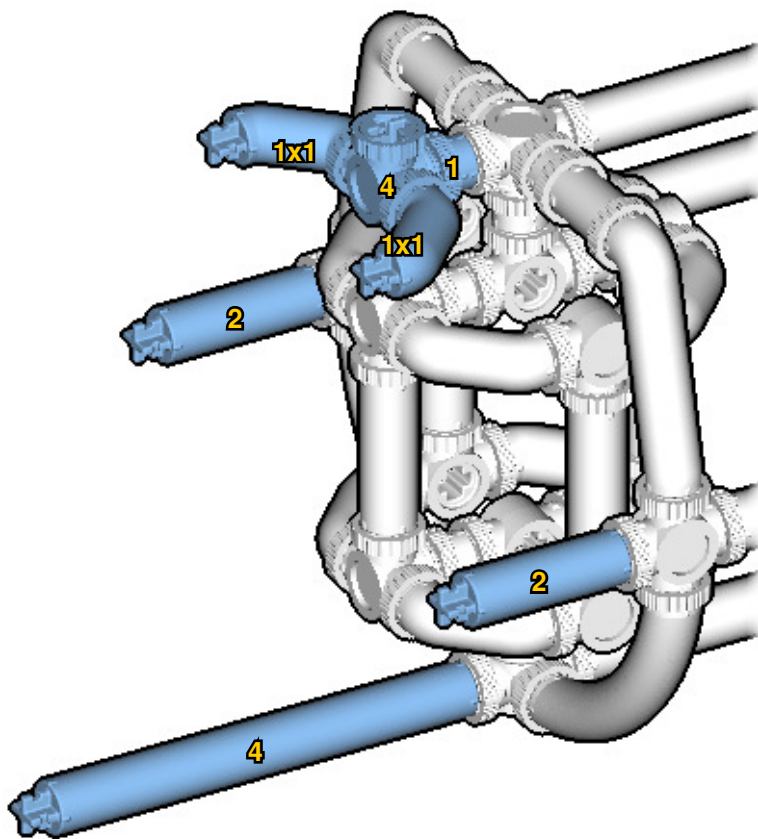

35

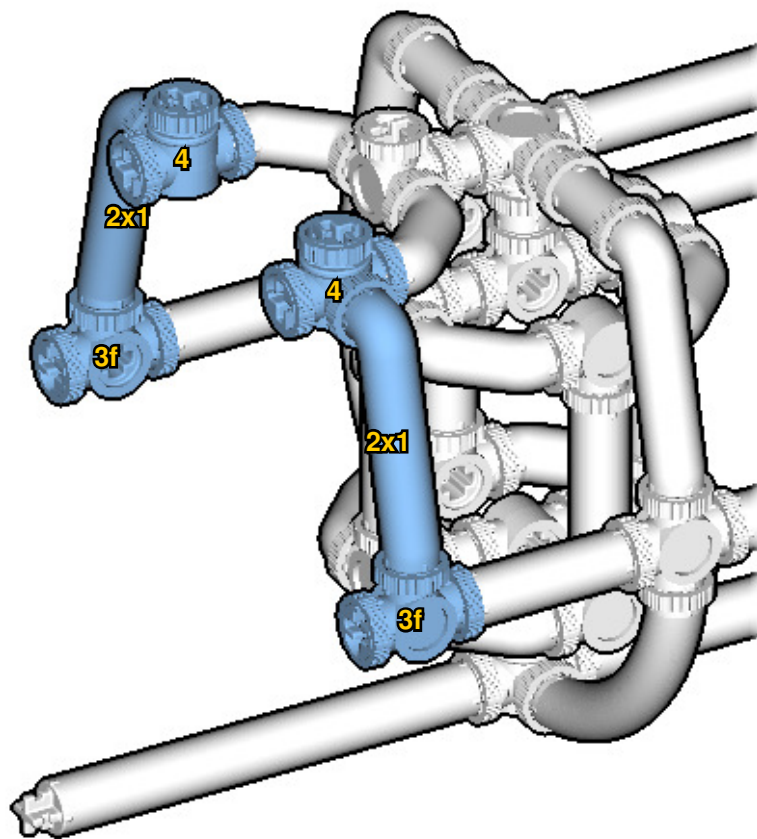

36

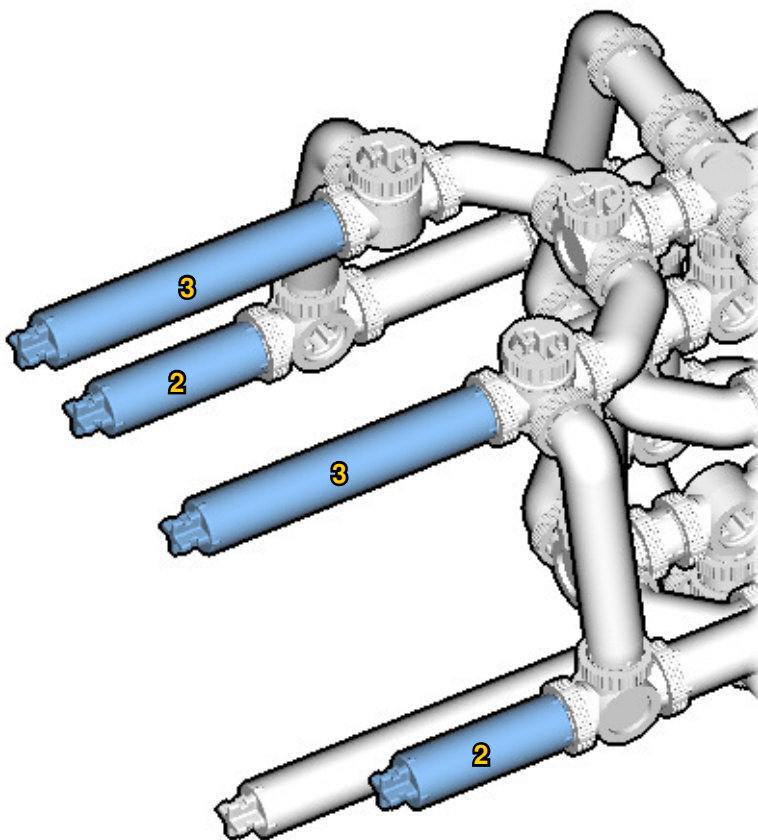

37

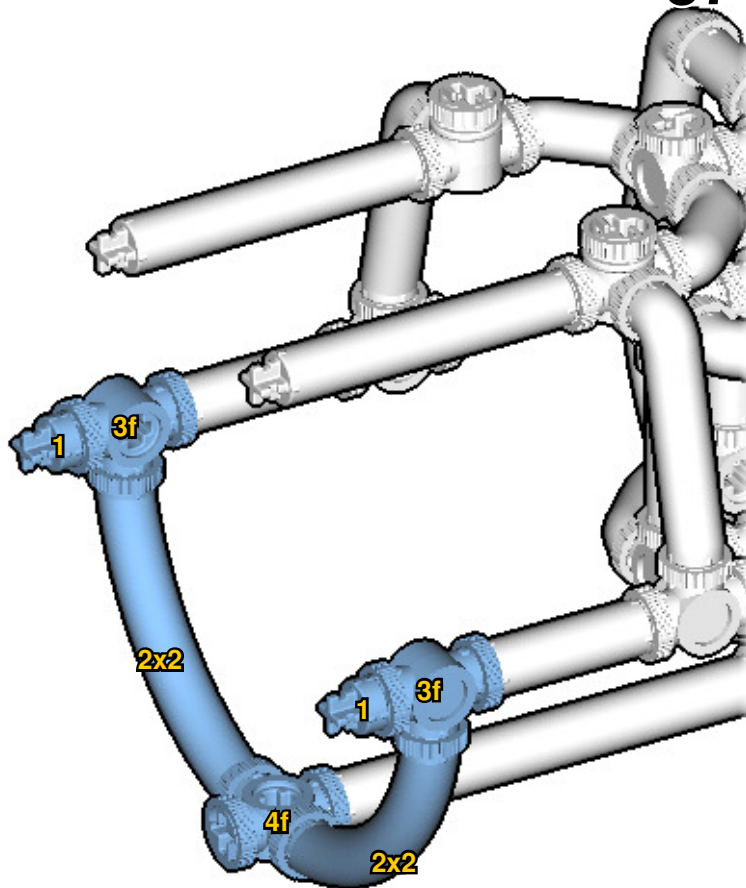

38

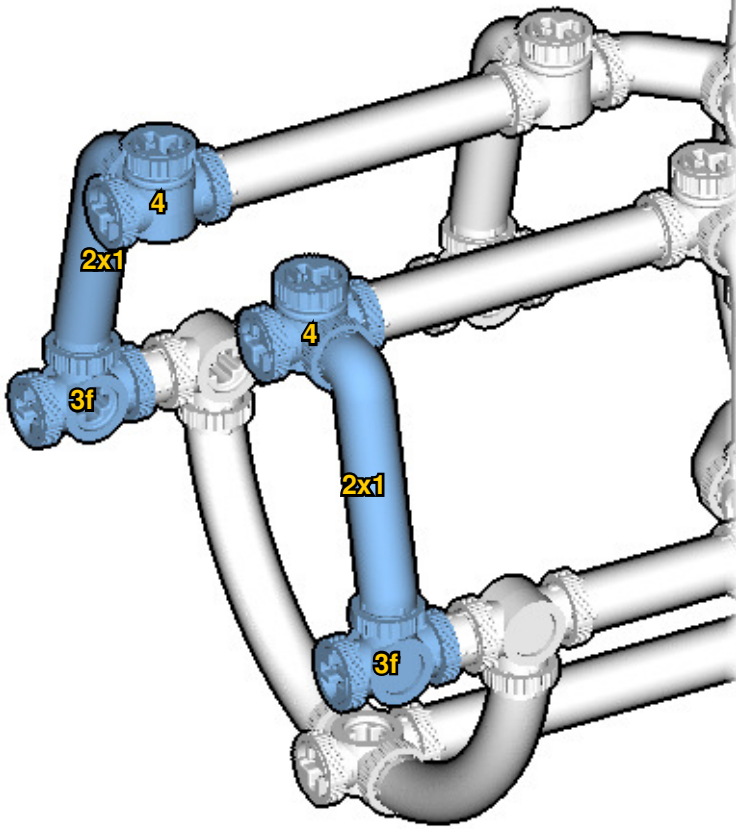

39

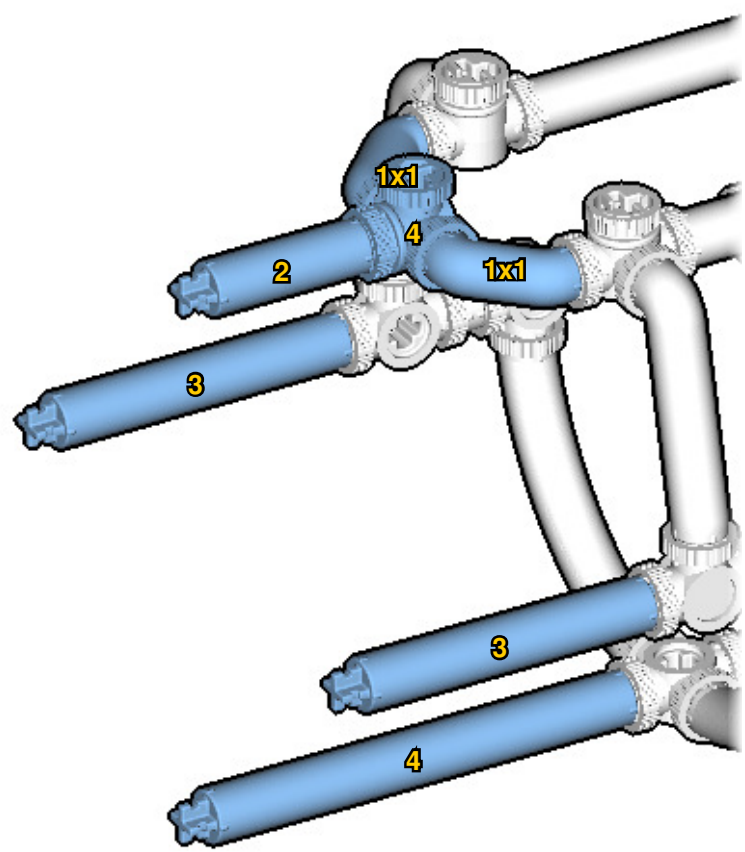

40

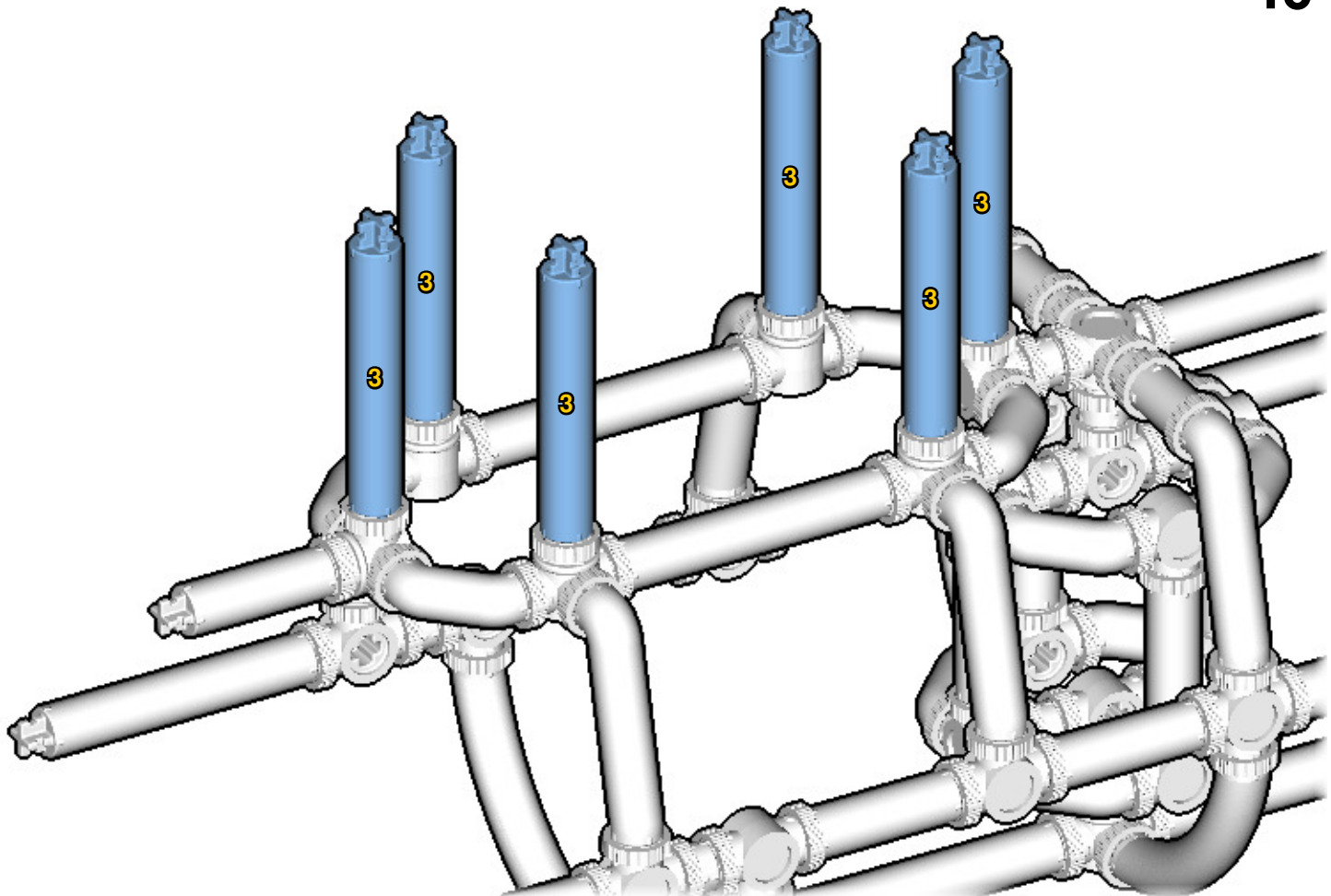

41

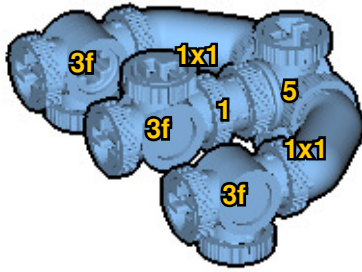

42

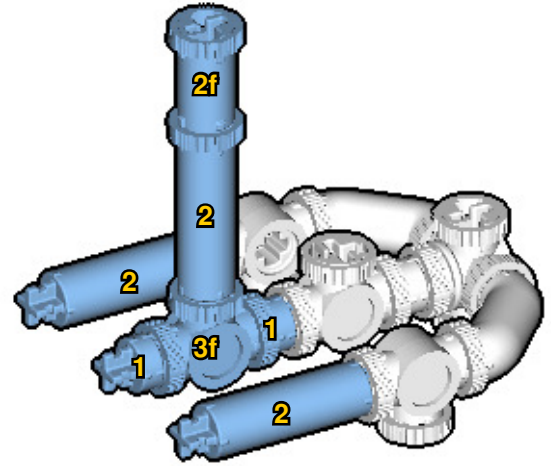

43

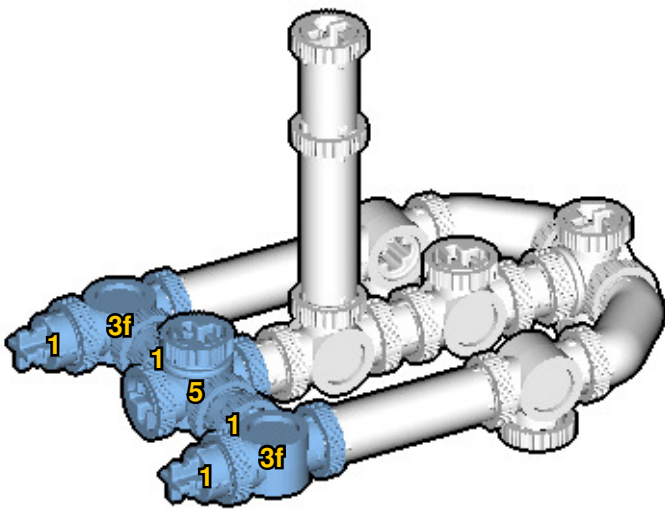

44

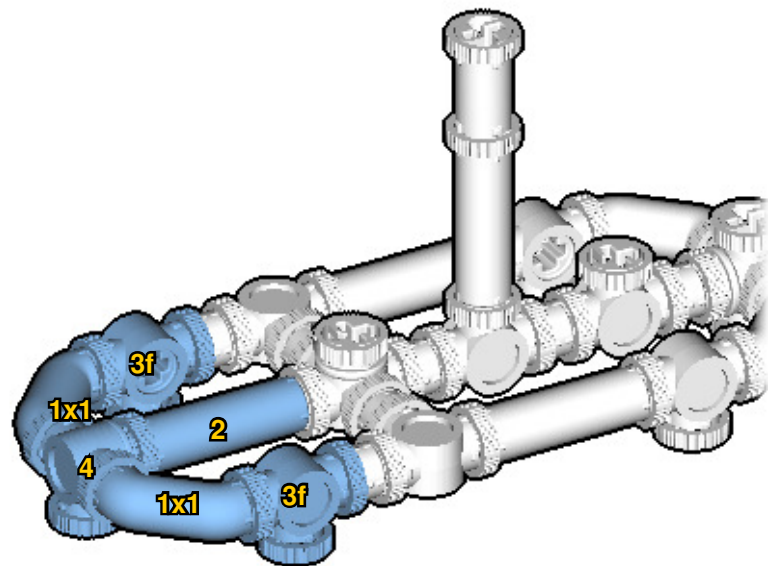

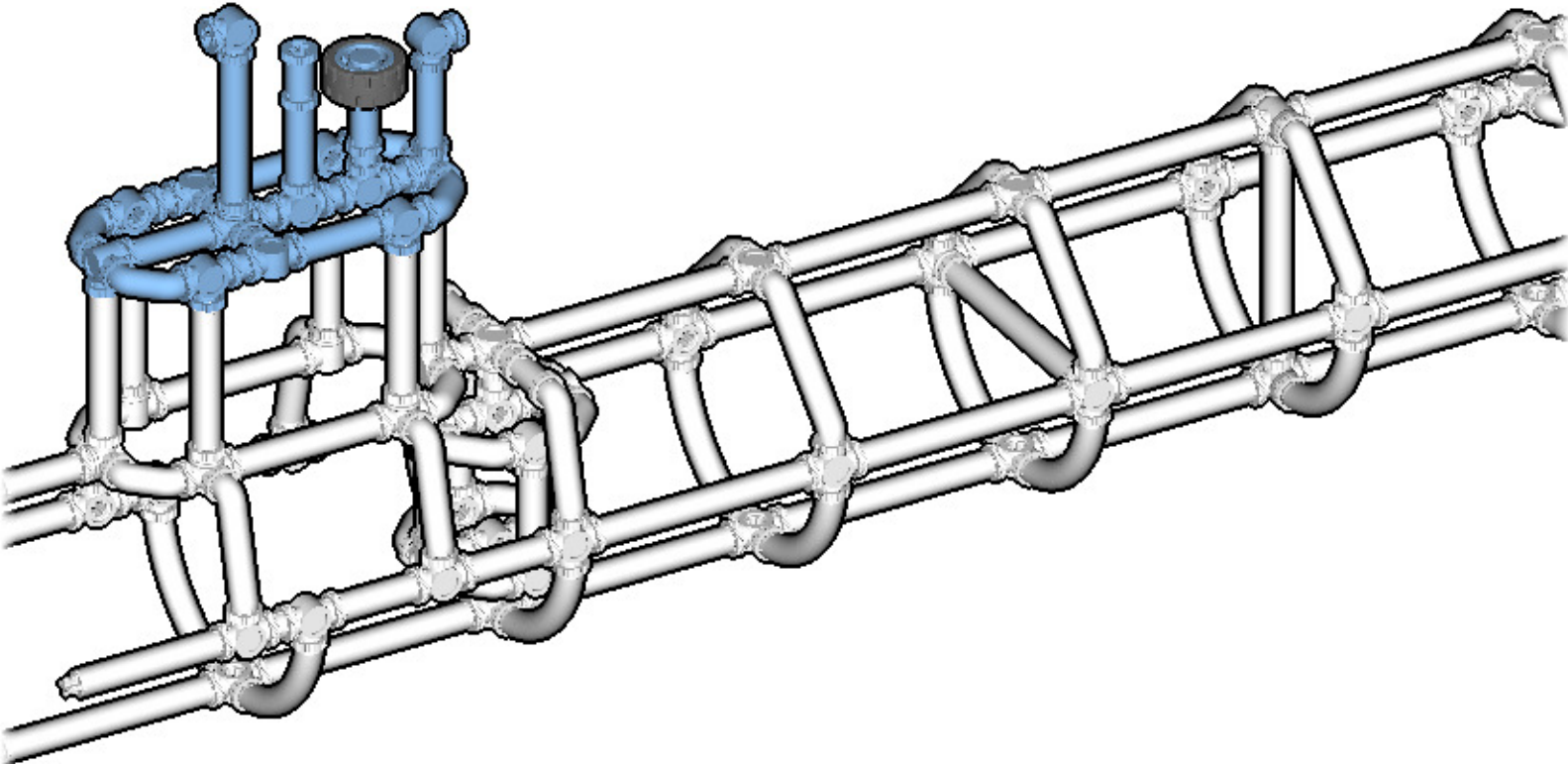
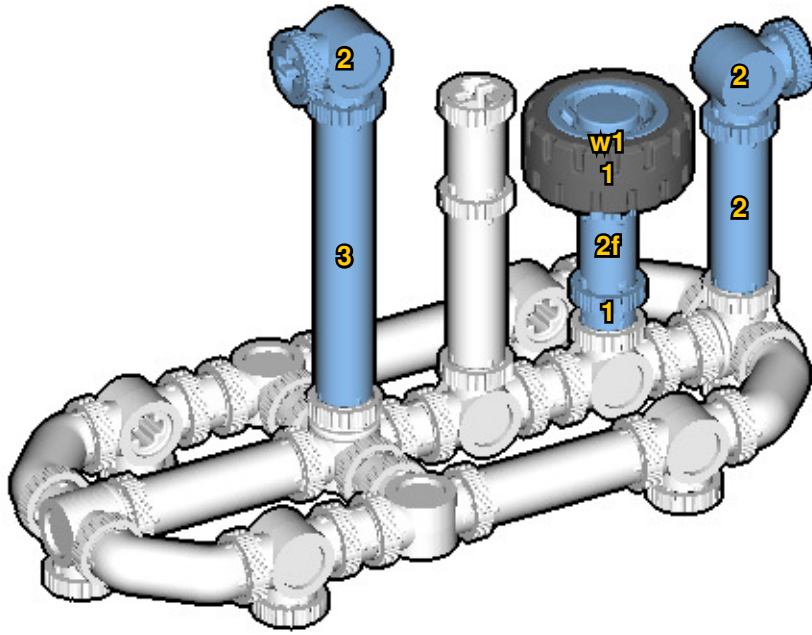
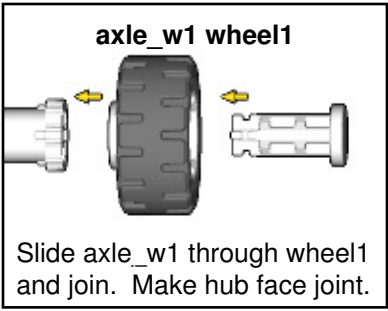

47

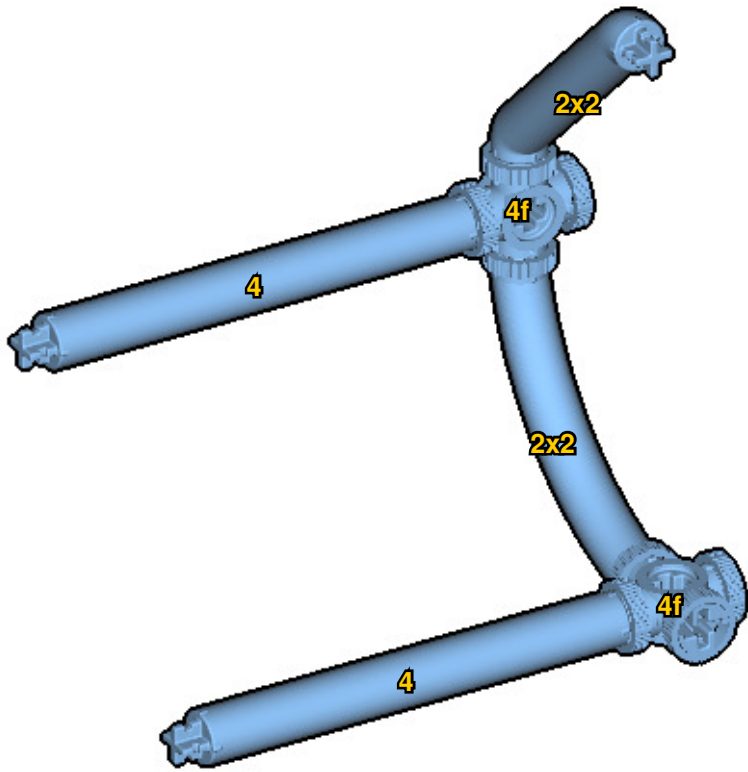

48

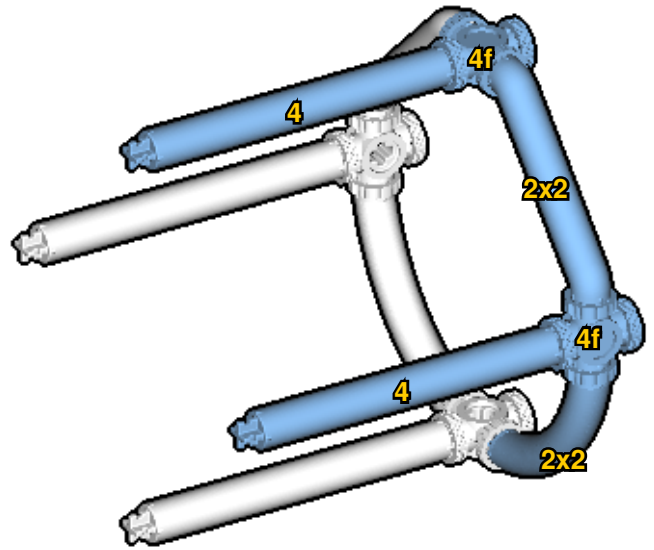

49

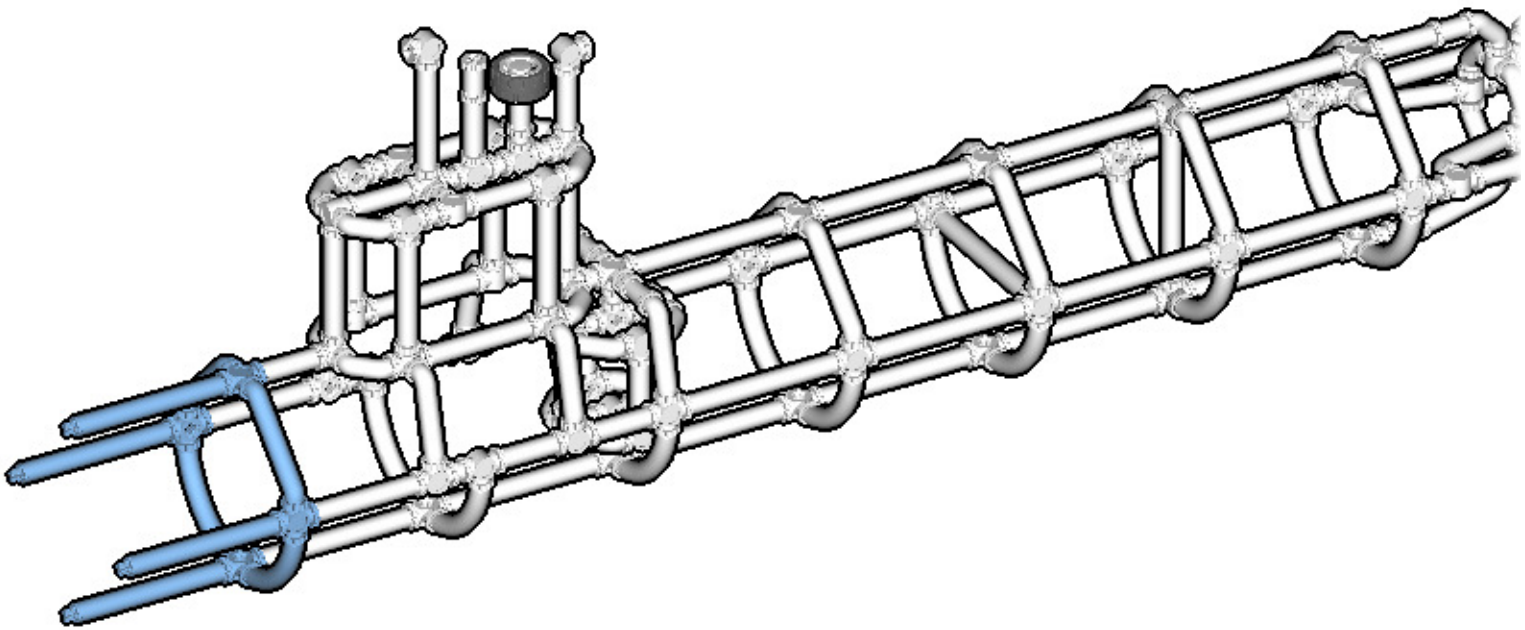

50

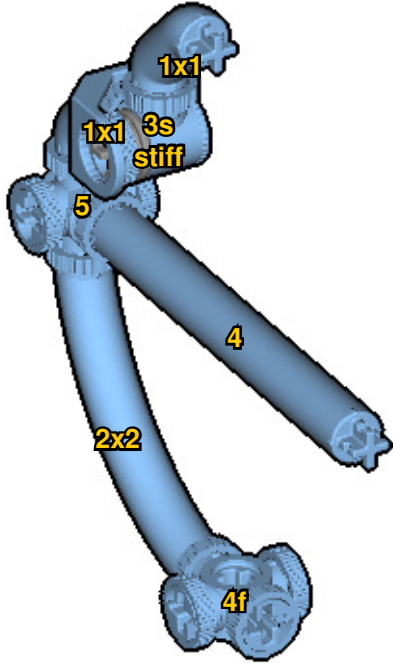

51

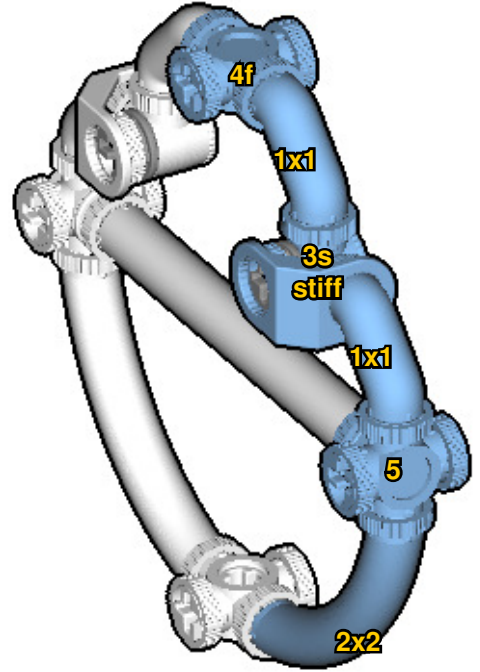

52

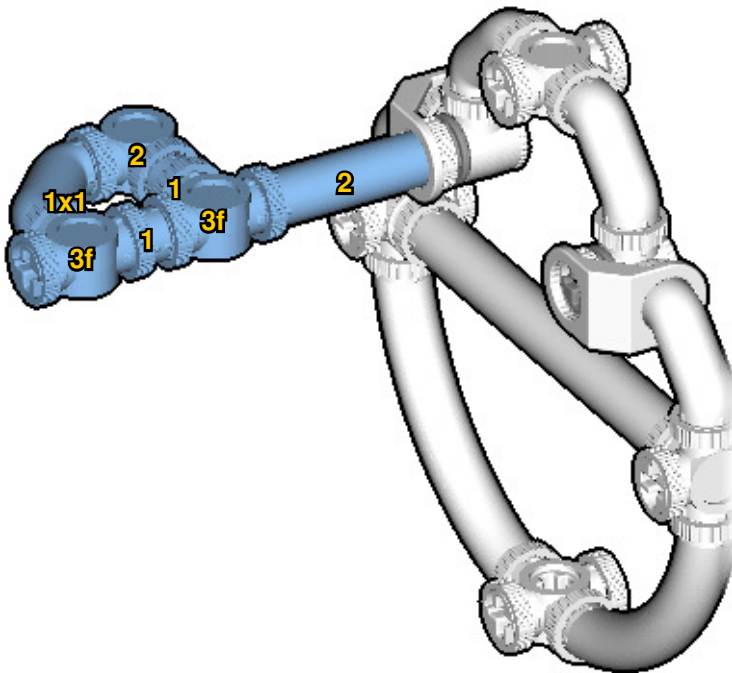

53

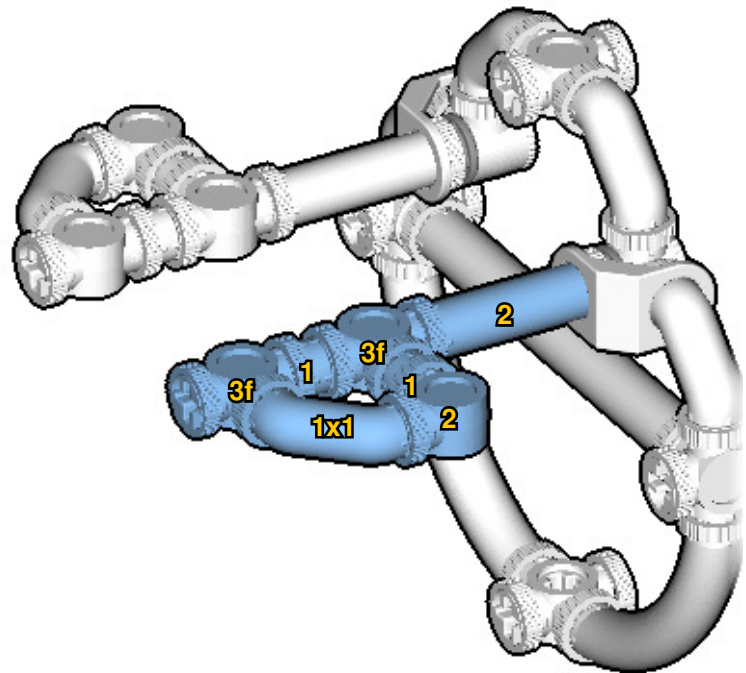

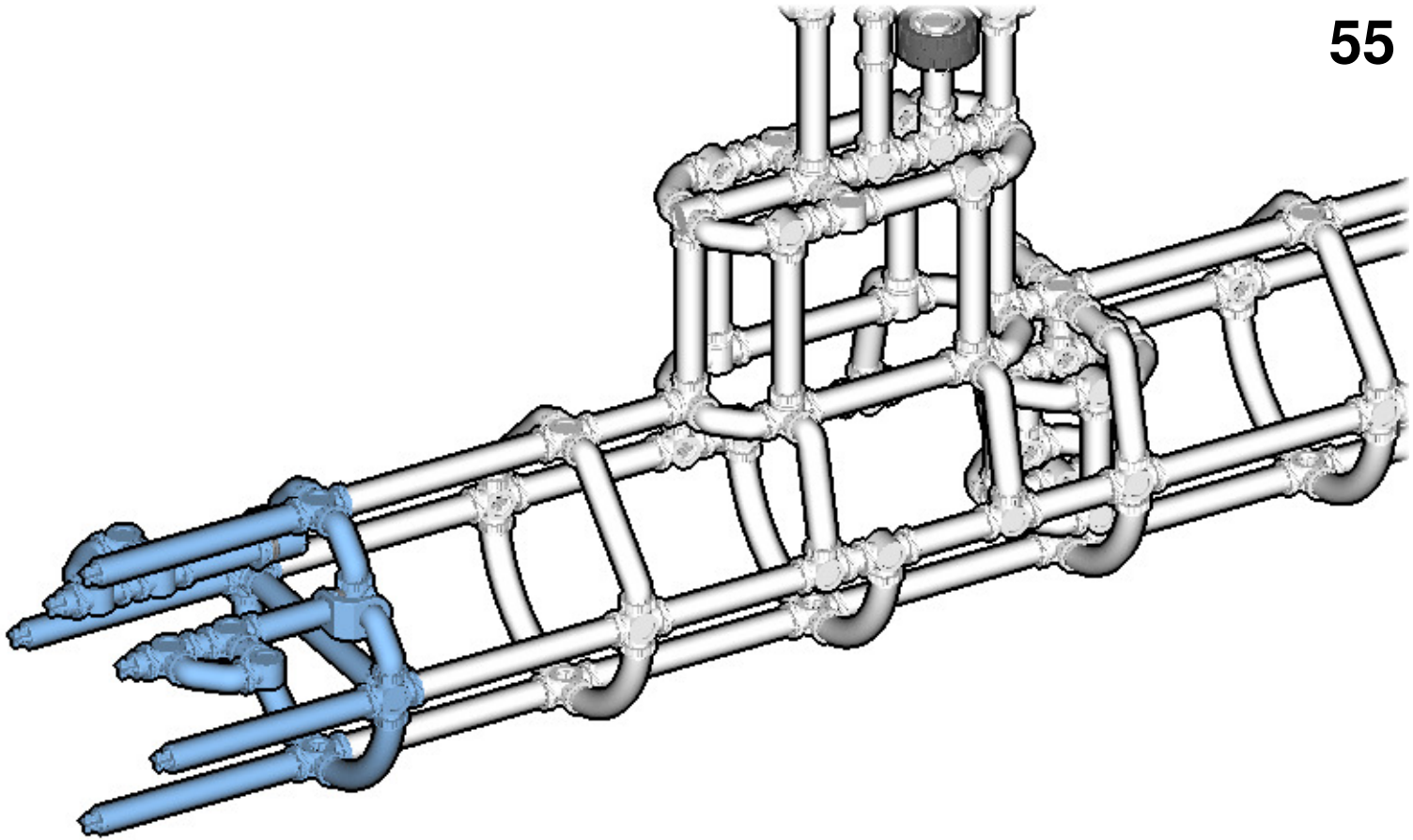
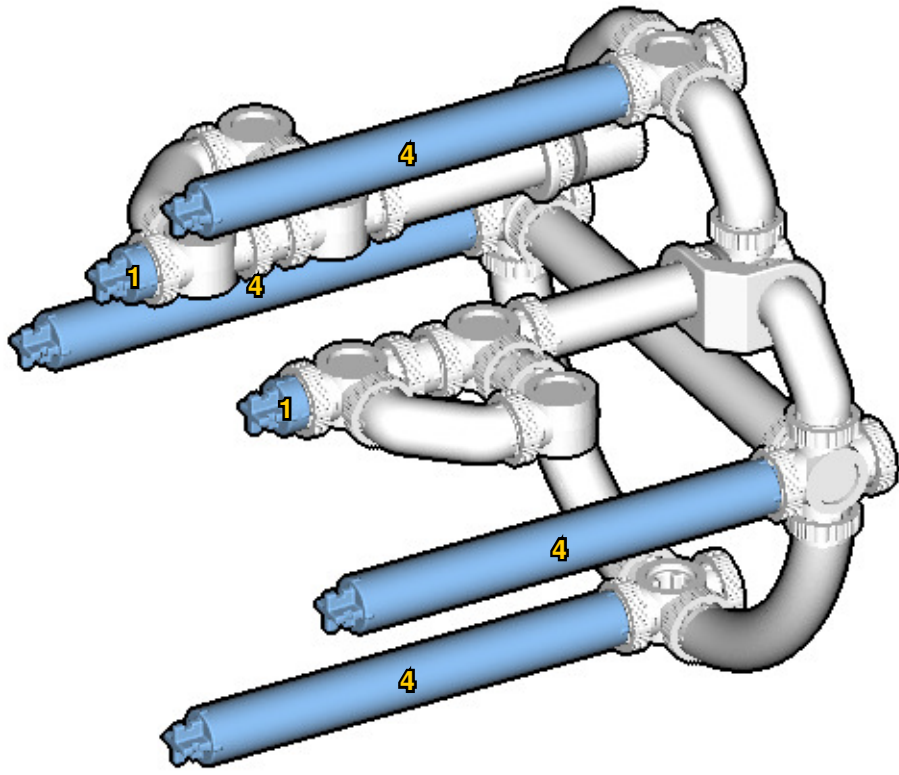

56

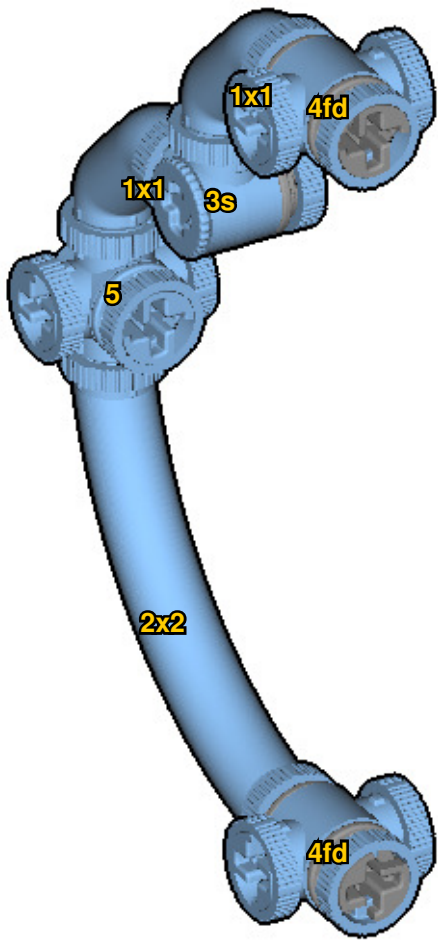

57

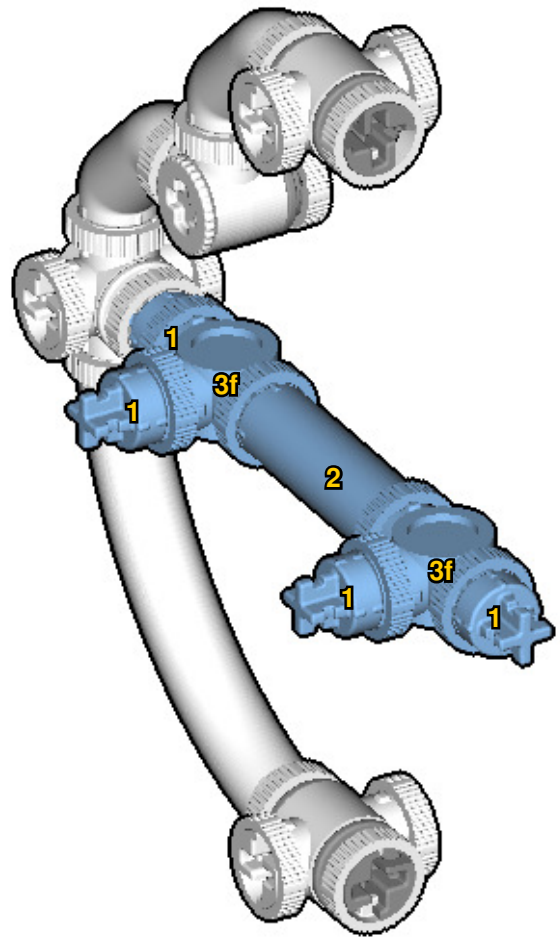

58

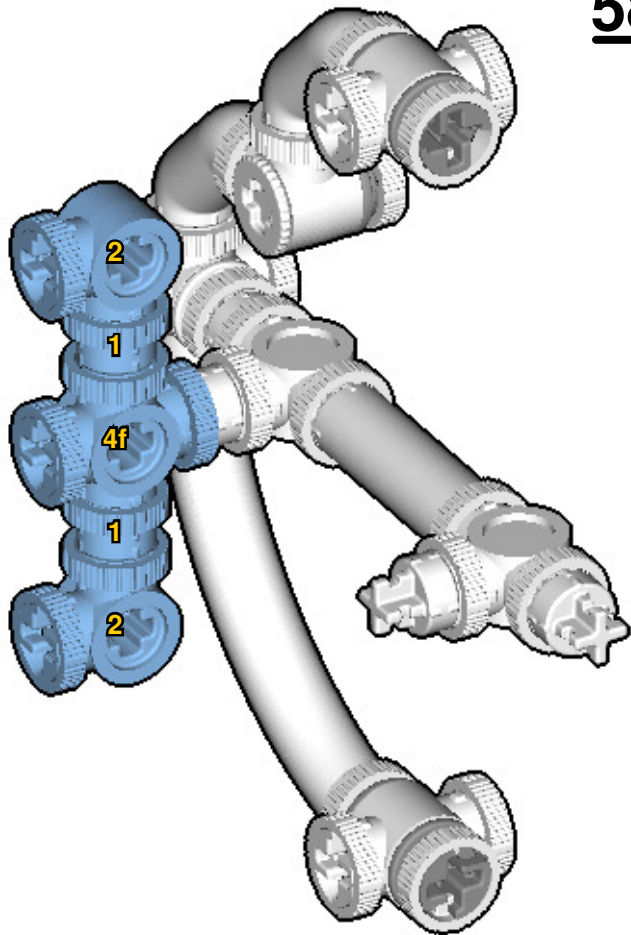

59

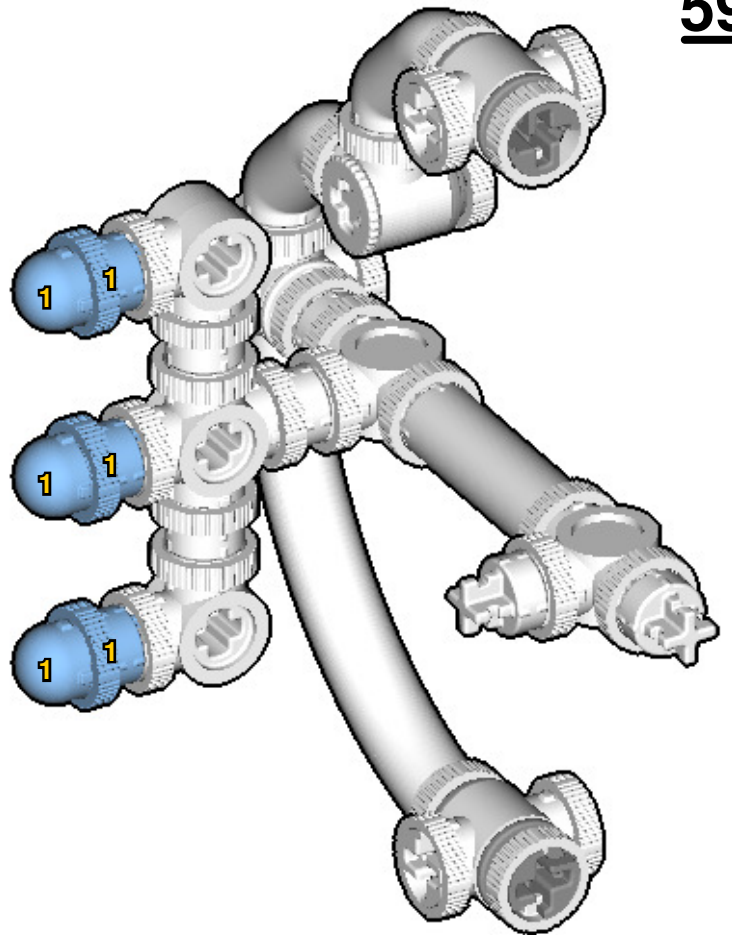

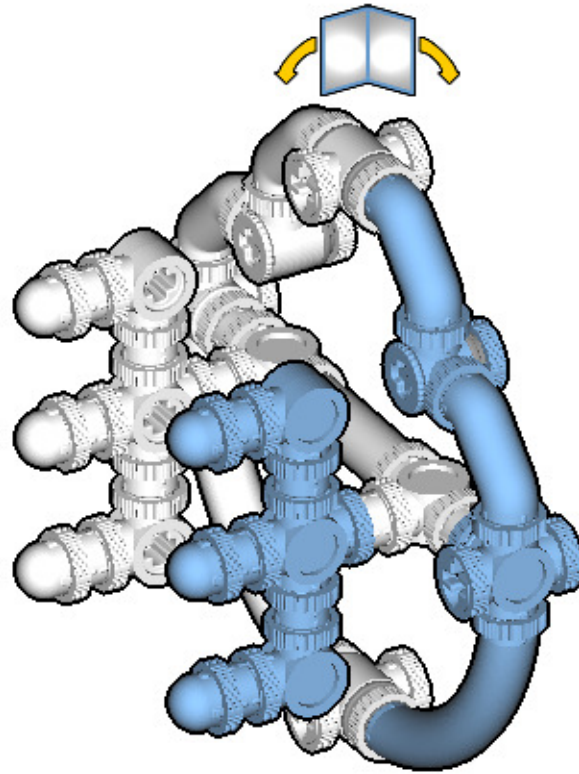

 : Copy new pieces from old pieces.

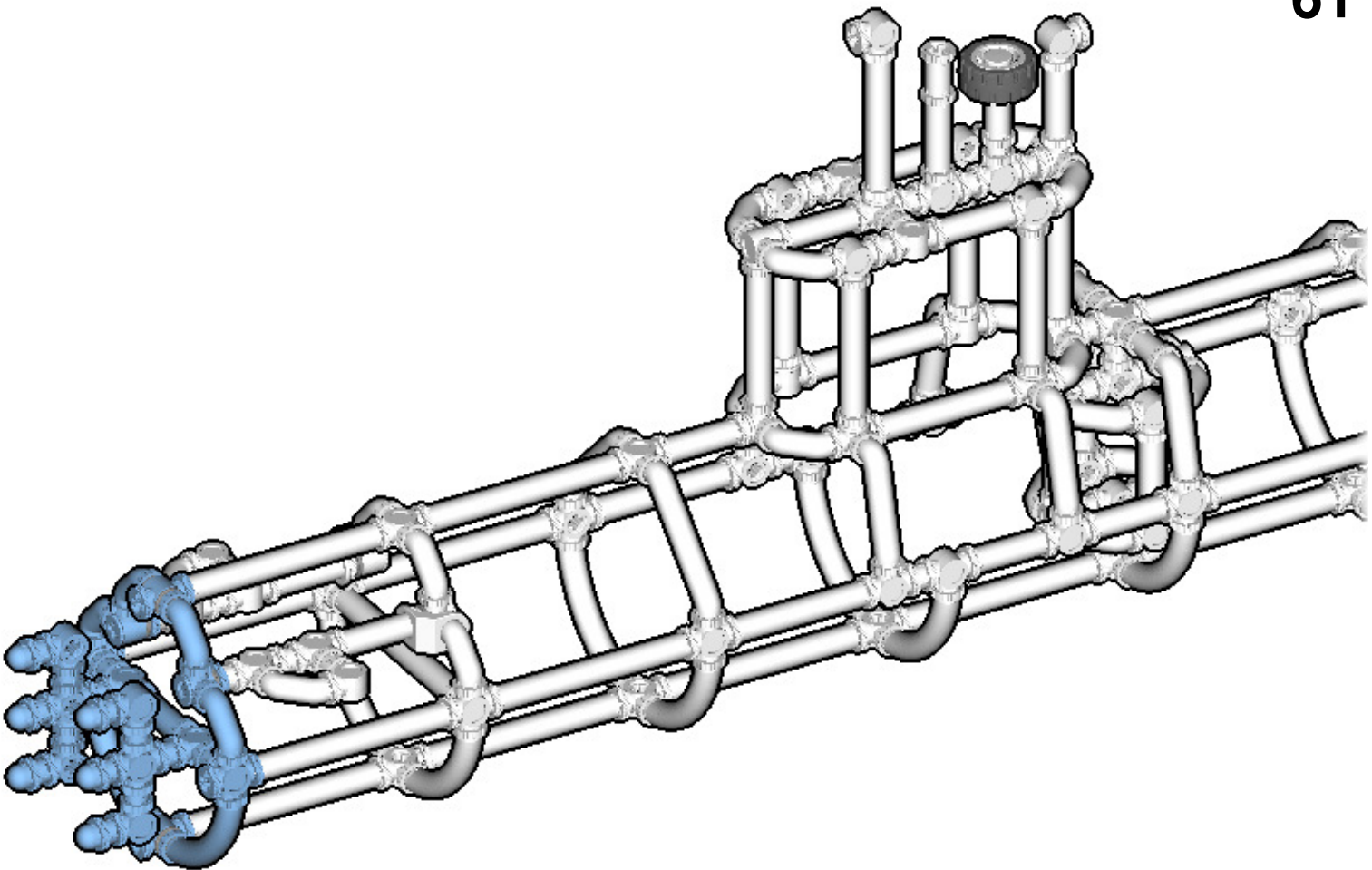

62

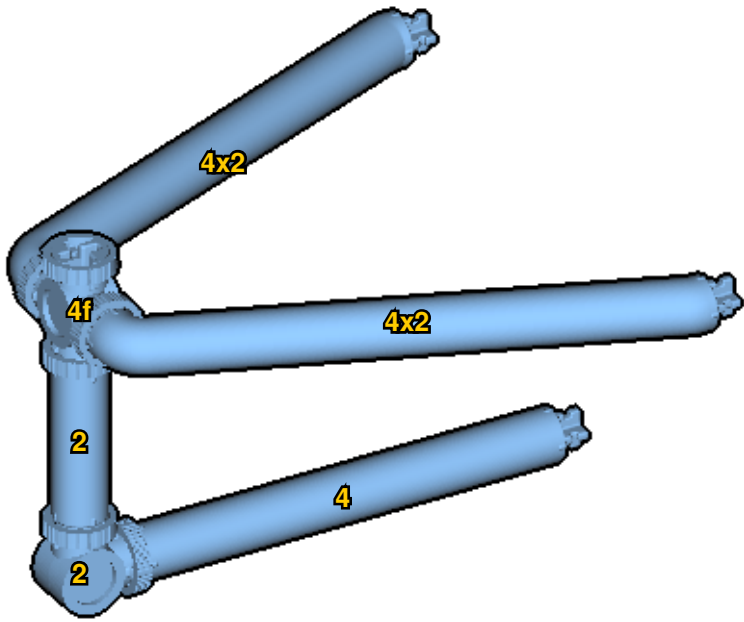

63

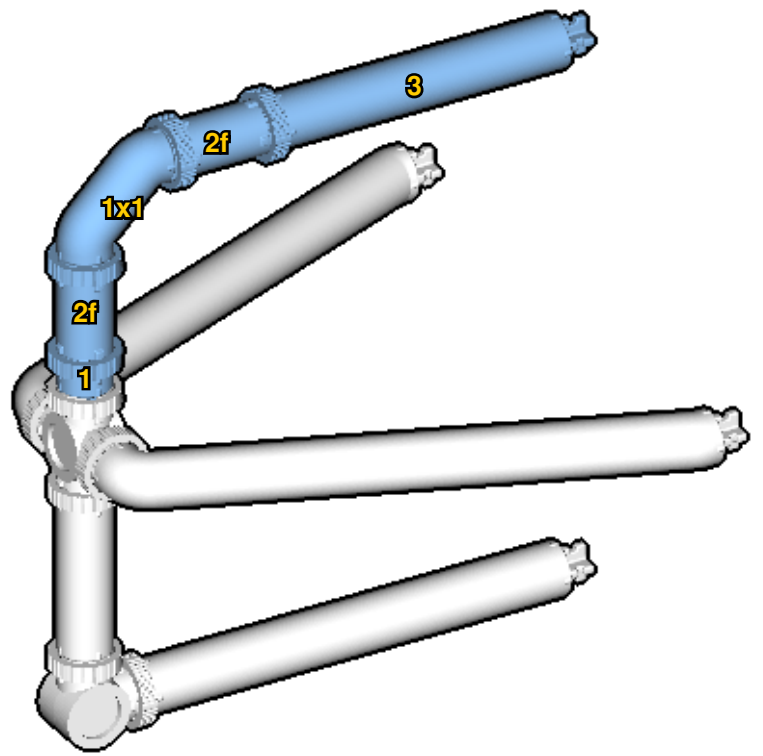

64

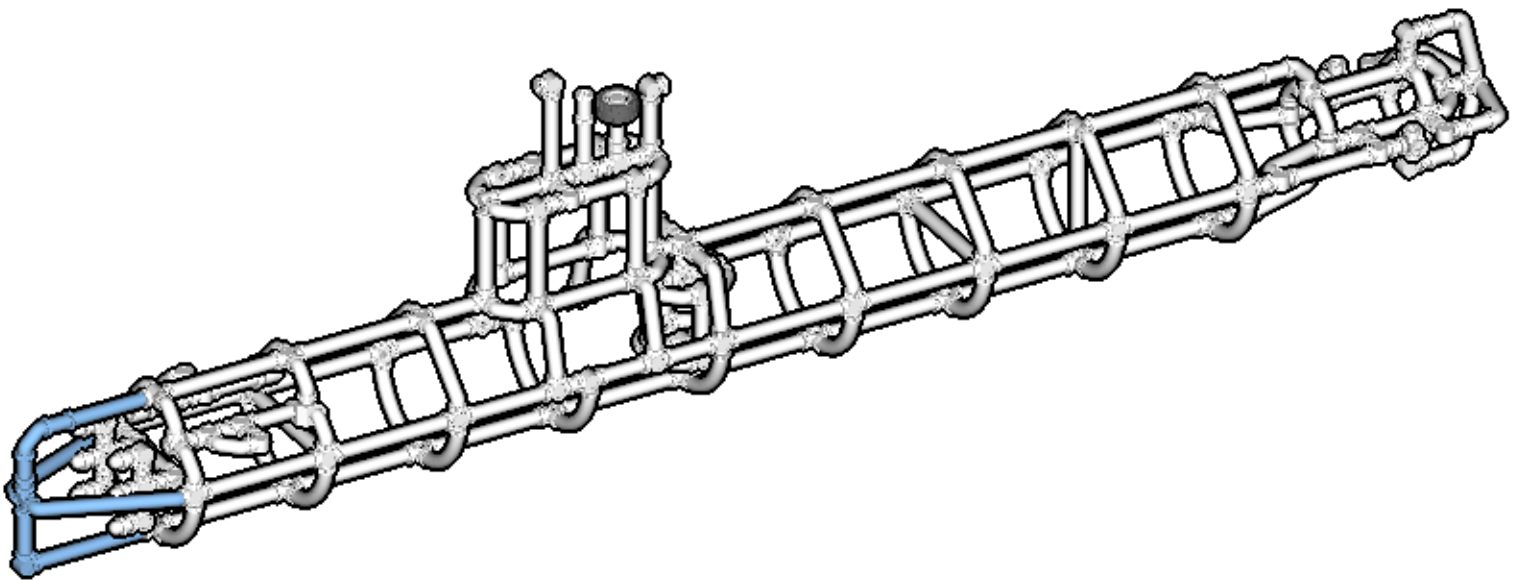

INVENTORY

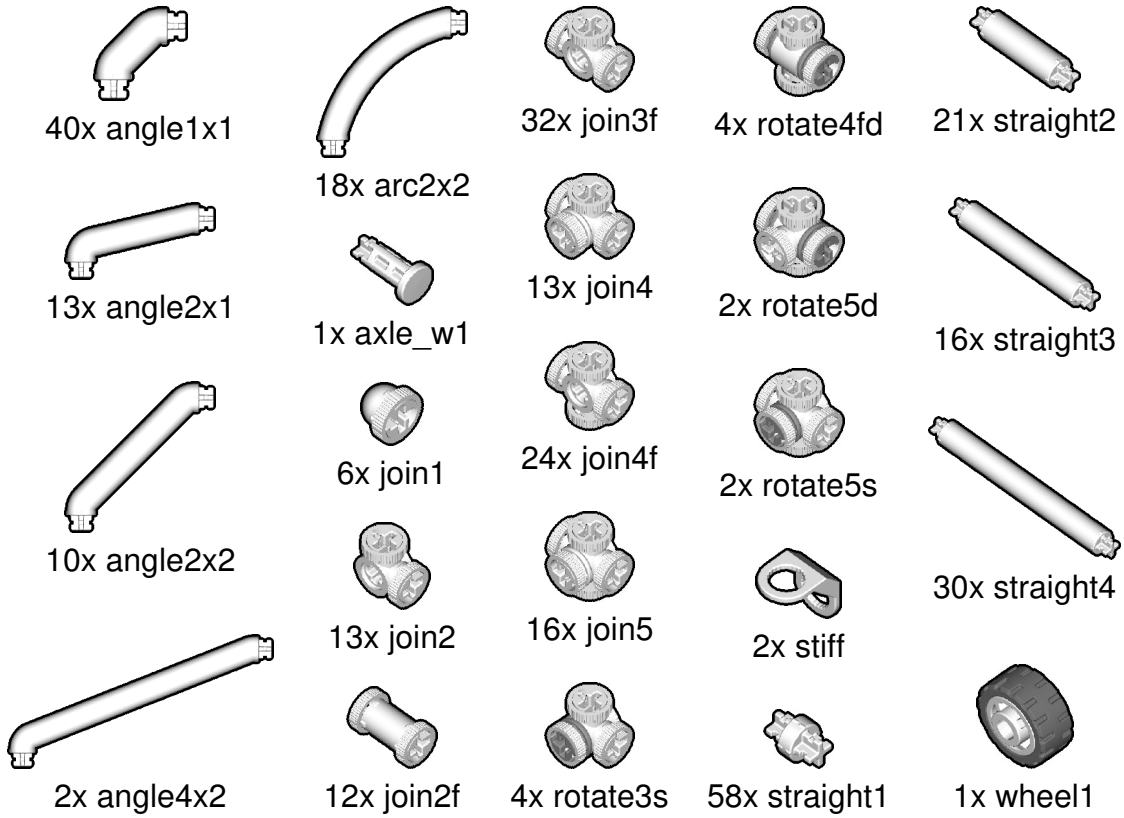

ACTUAL SIZE

