

RECONNAISSANCE PLANE

SIZE	2.4ft x 1.5ft x 0.4ft	PIECES	360
DESIGNER	Charles Sharman	MADE IN	U.S.A.

⚠ WARNING: Small parts. Age 14+. Not a toy. Handle responsibly. U.S. Patent 9,086,087.



Wrong
Connecting/Disconnecting Two Directions

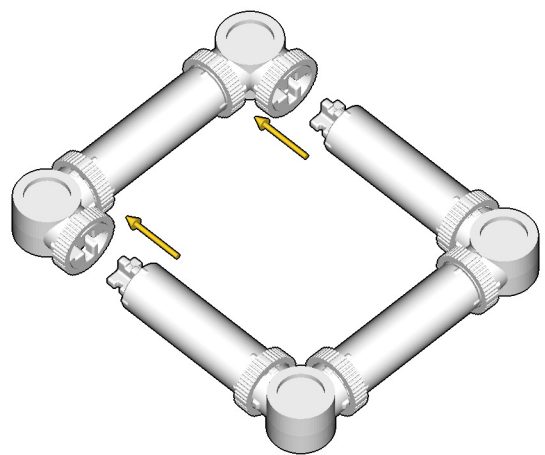

Right
Connecting/Disconnecting One Direction

1

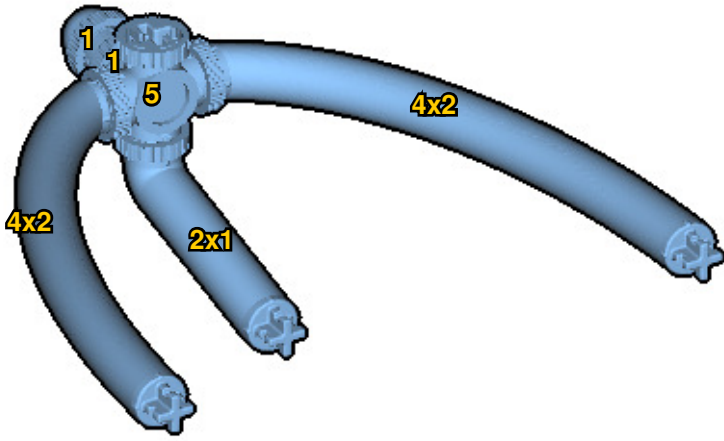

New pieces are drawn blue. Old pieces are drawn white.
See back for piece names.

2

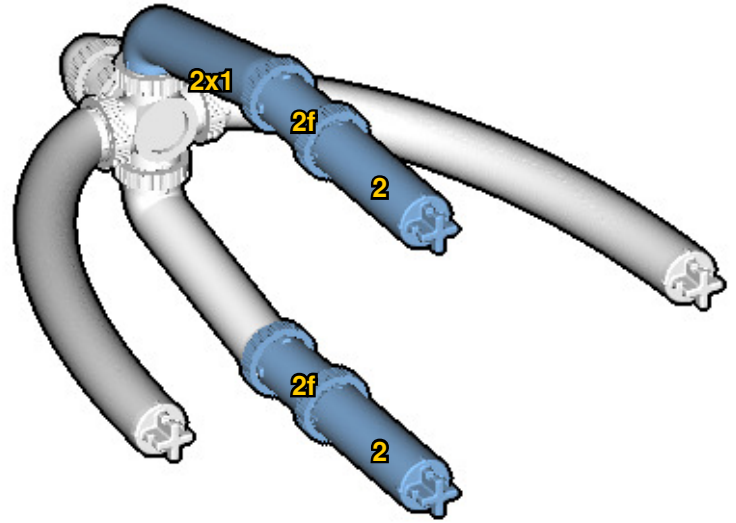

Connect new pieces together before connecting to old pieces.

3

Submodel begins →

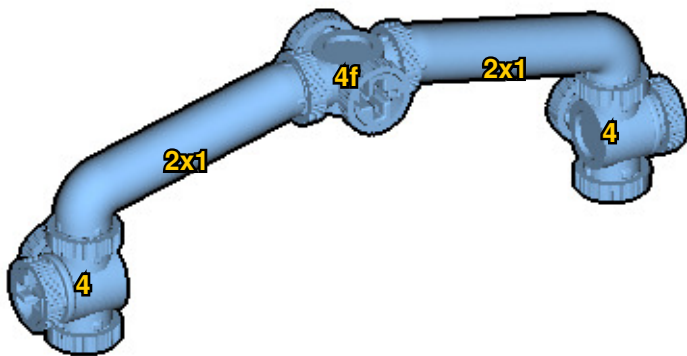

4

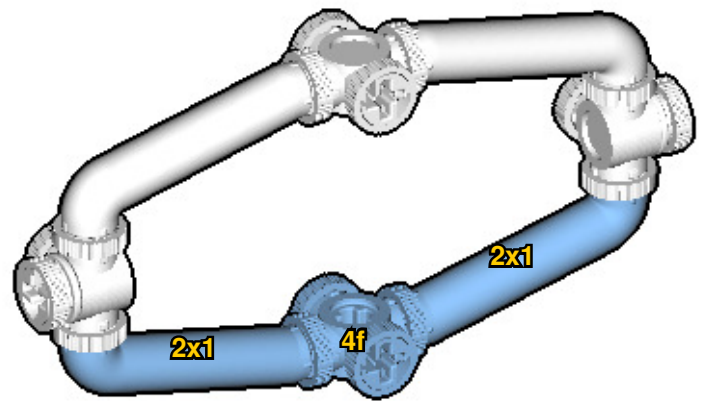

Submodel ends → **5**

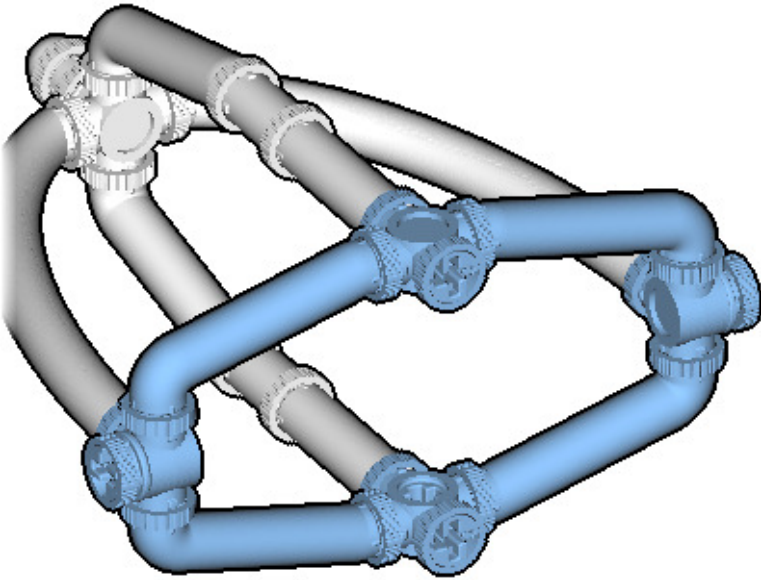

Connect submodel to model.

6

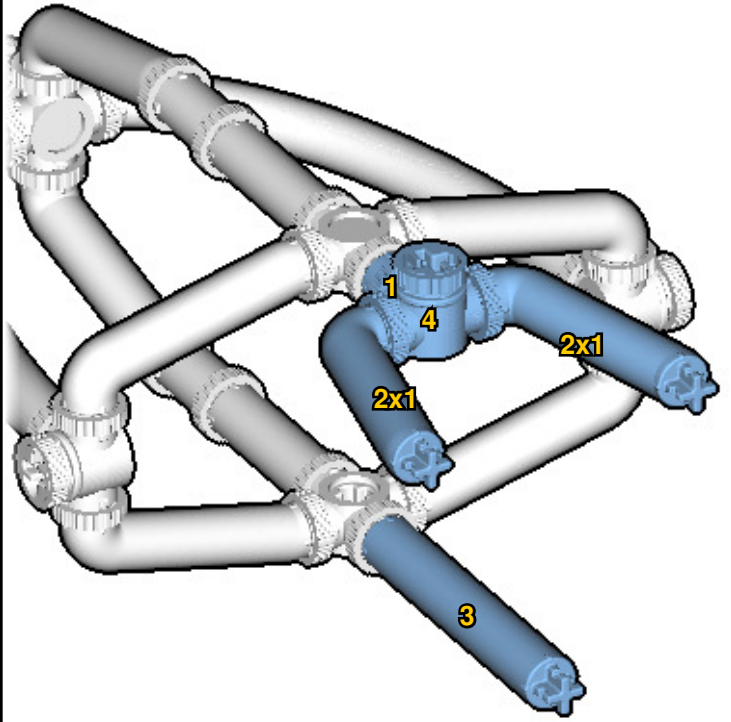

7

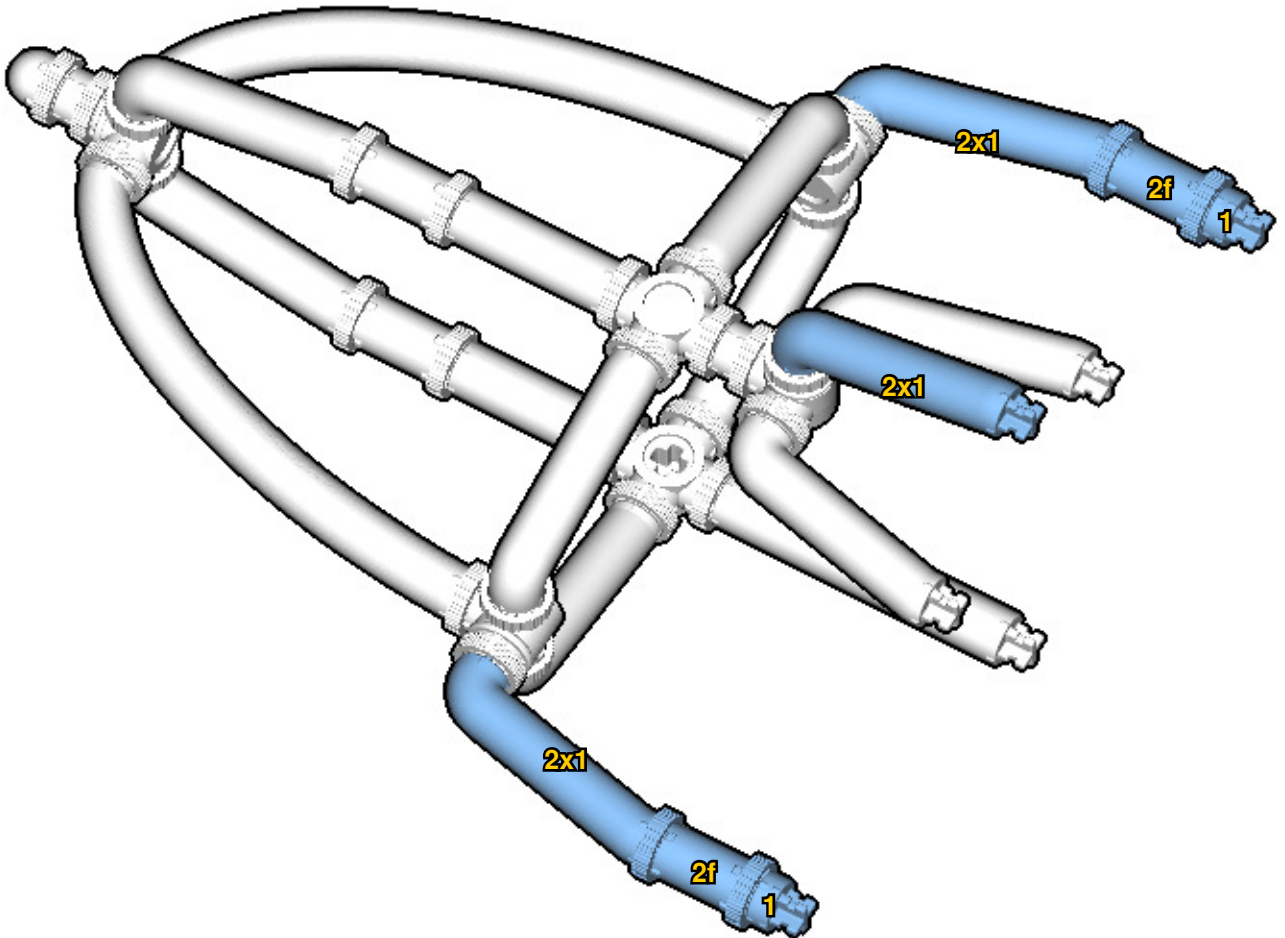

18

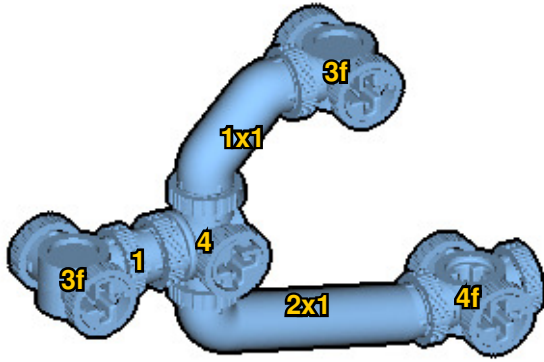

19

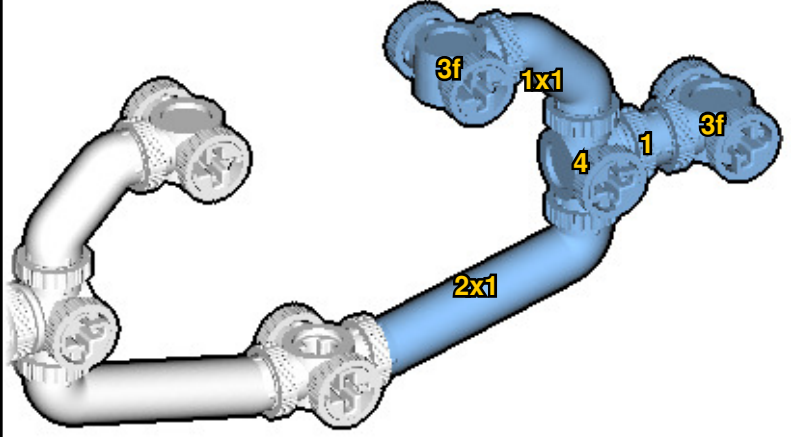

10

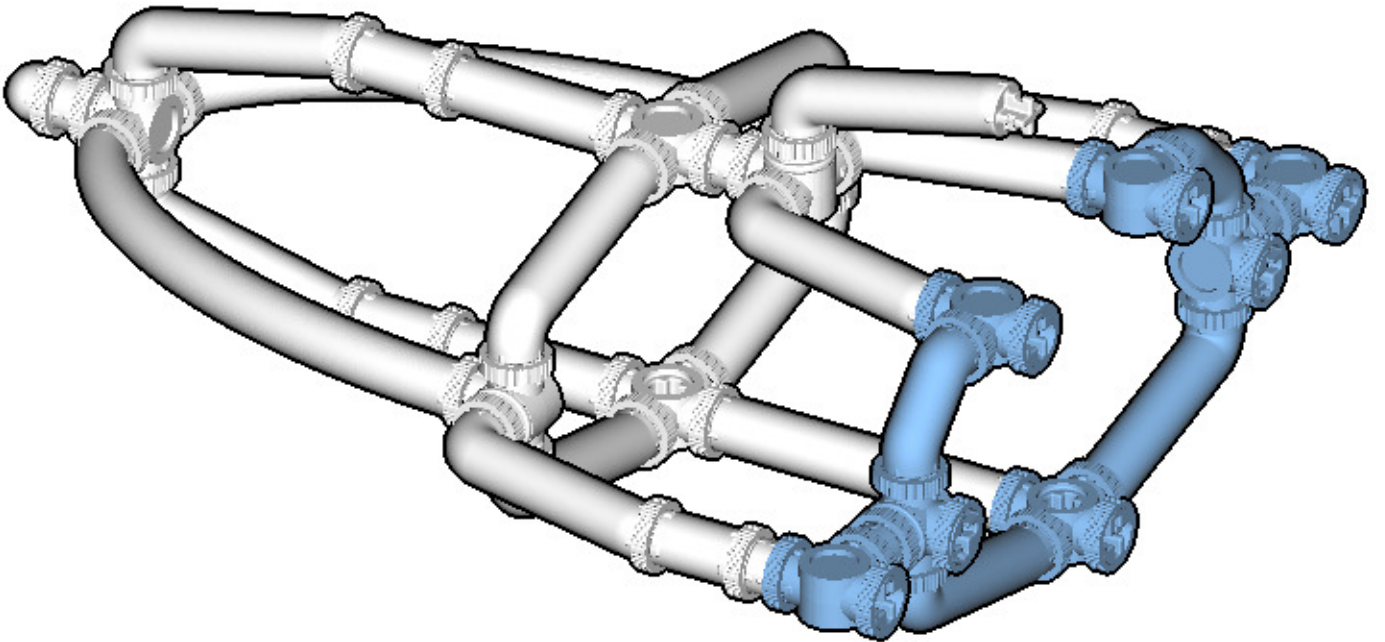

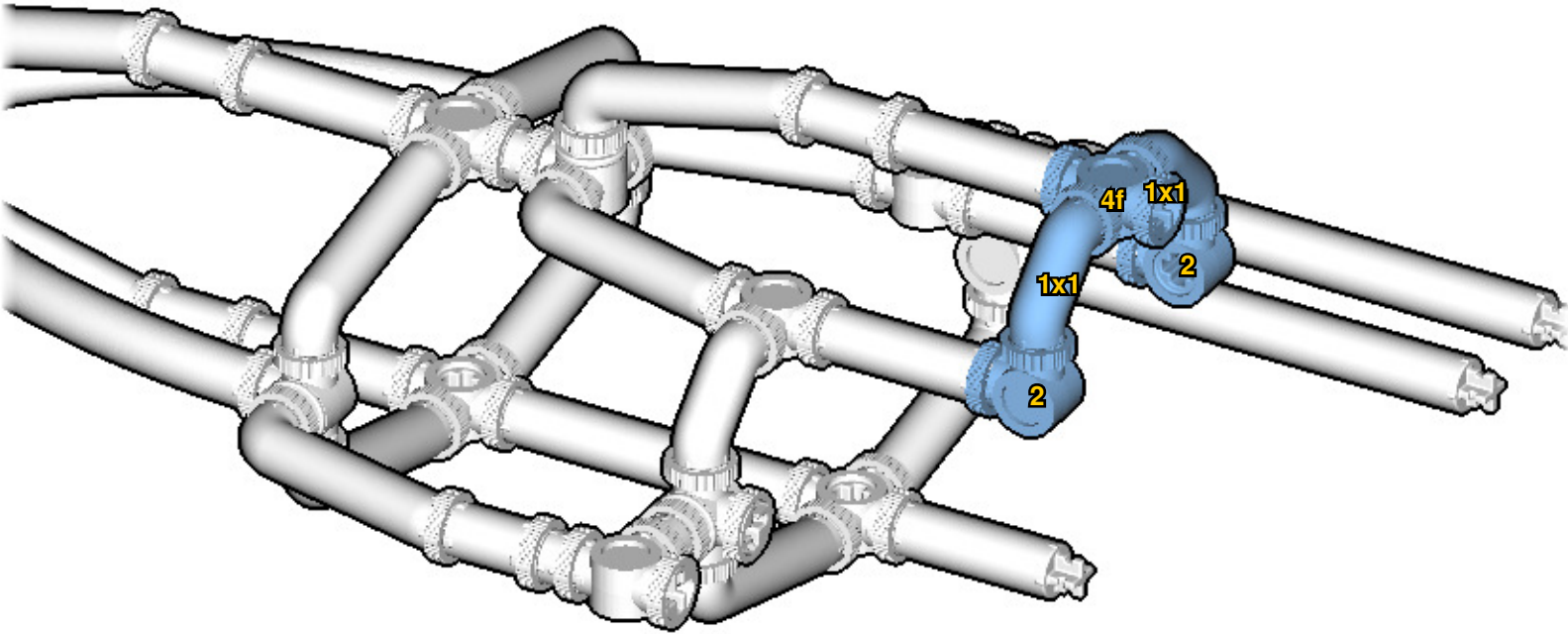
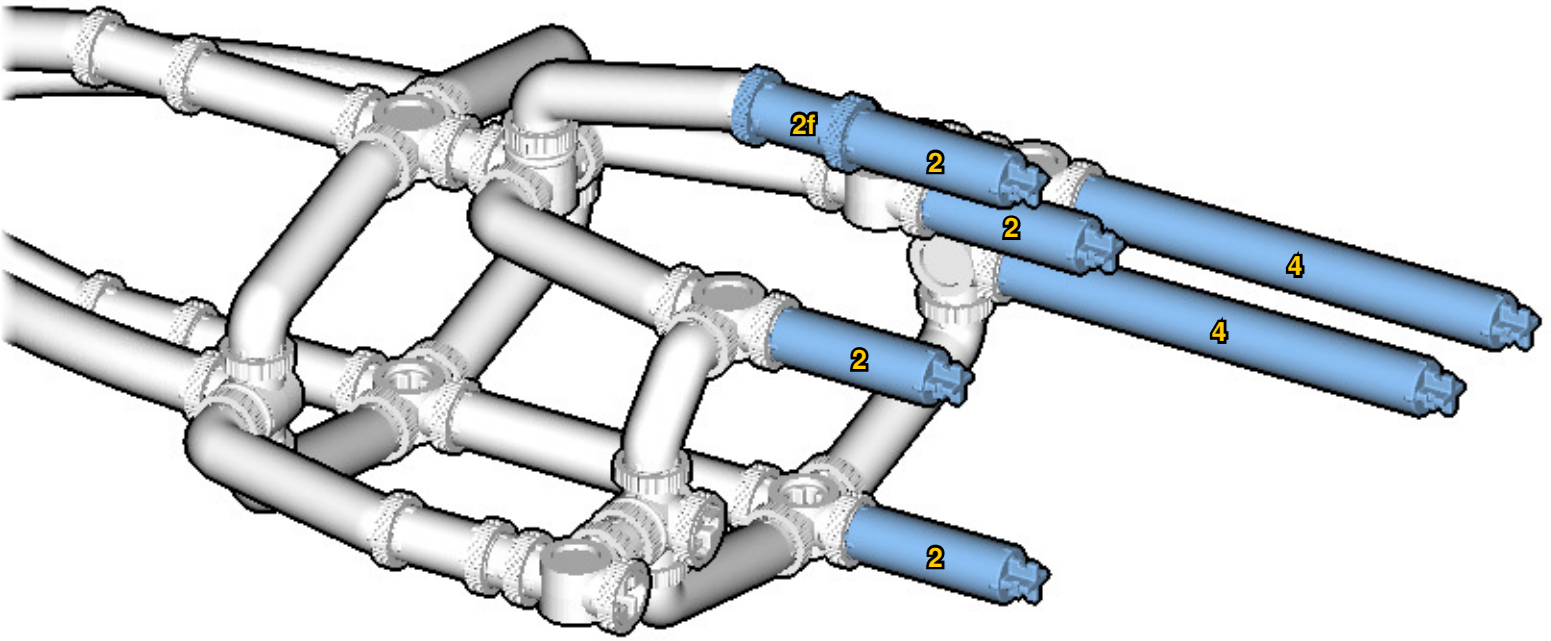

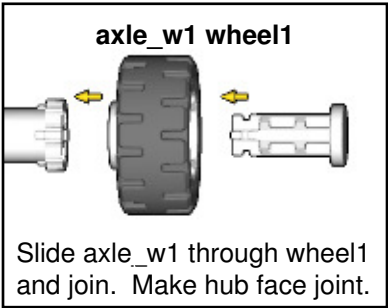
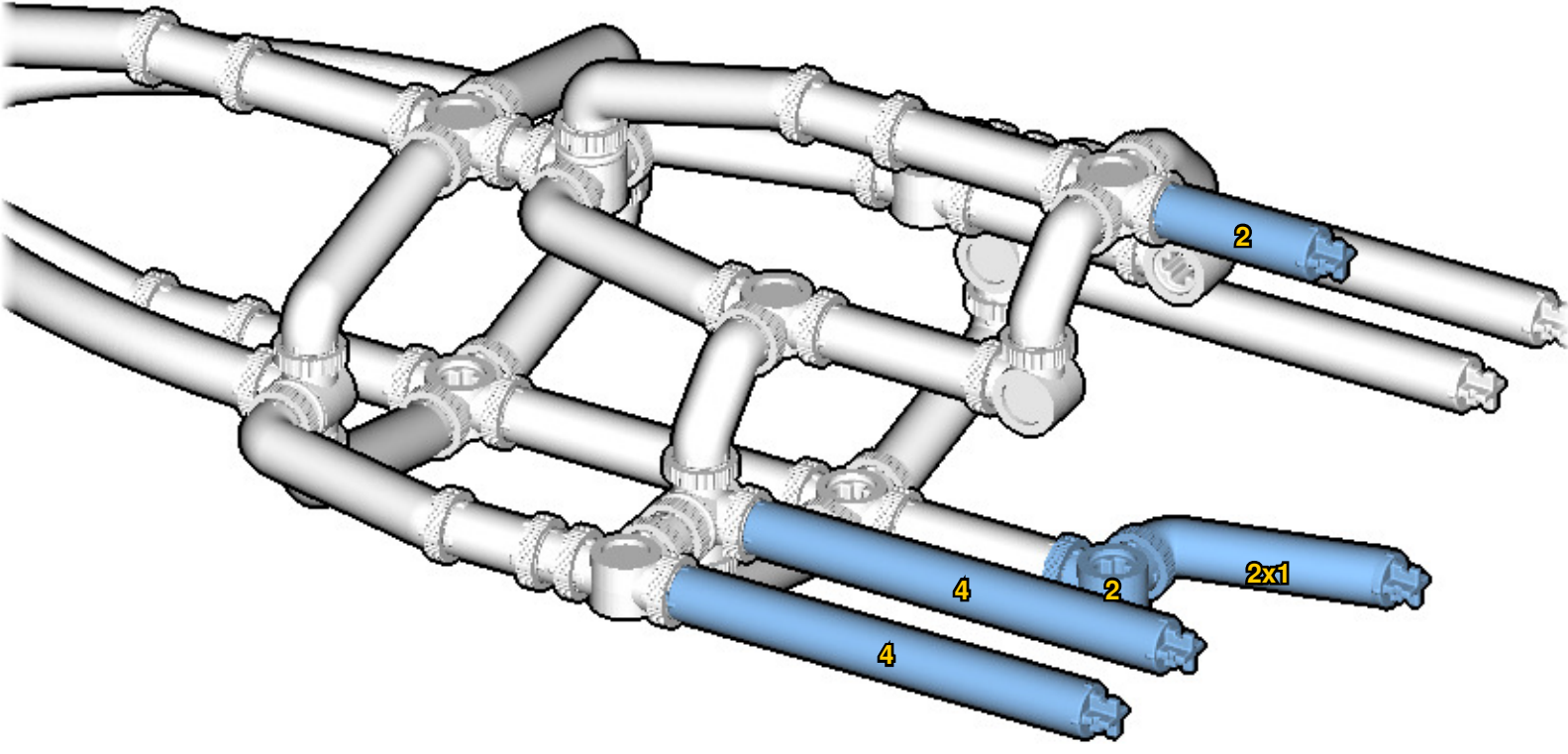

14



15

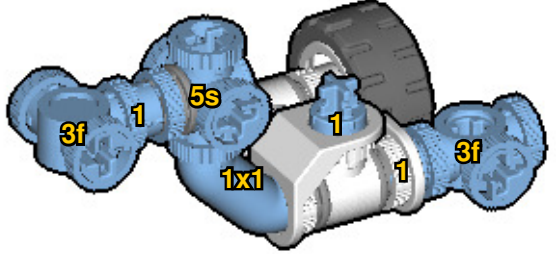

16

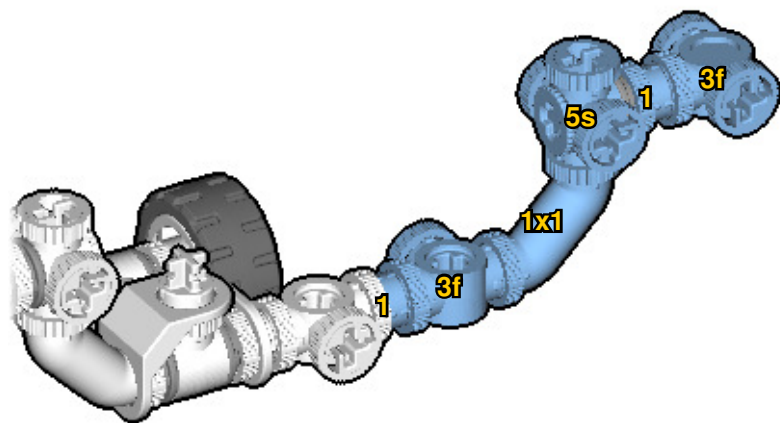

17

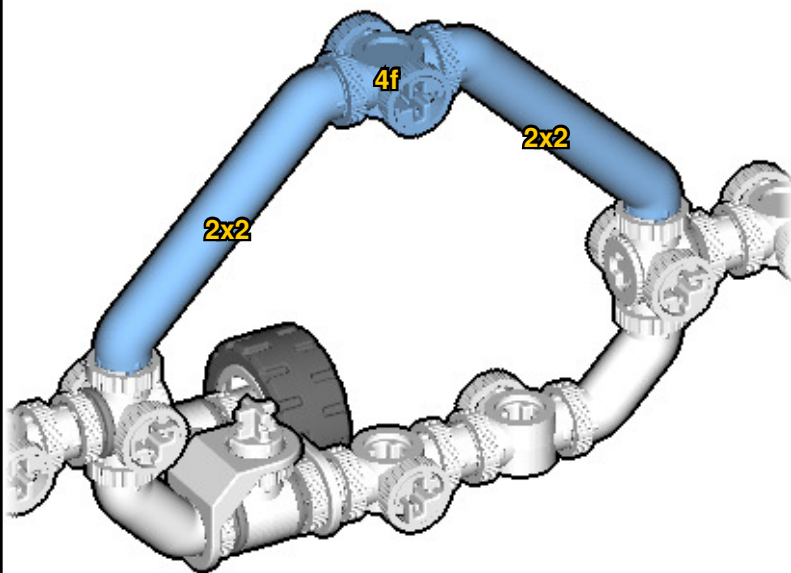

18

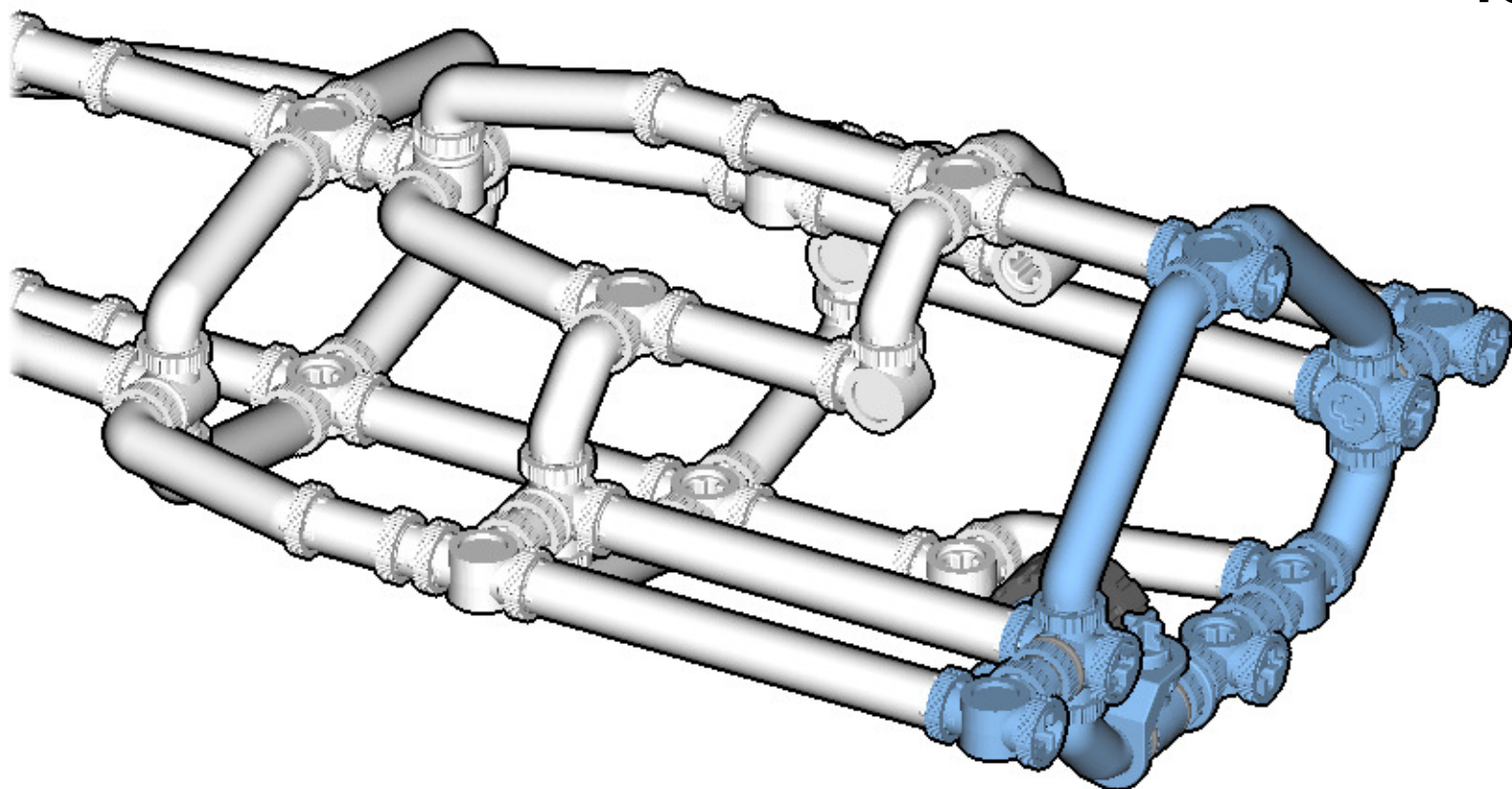

19

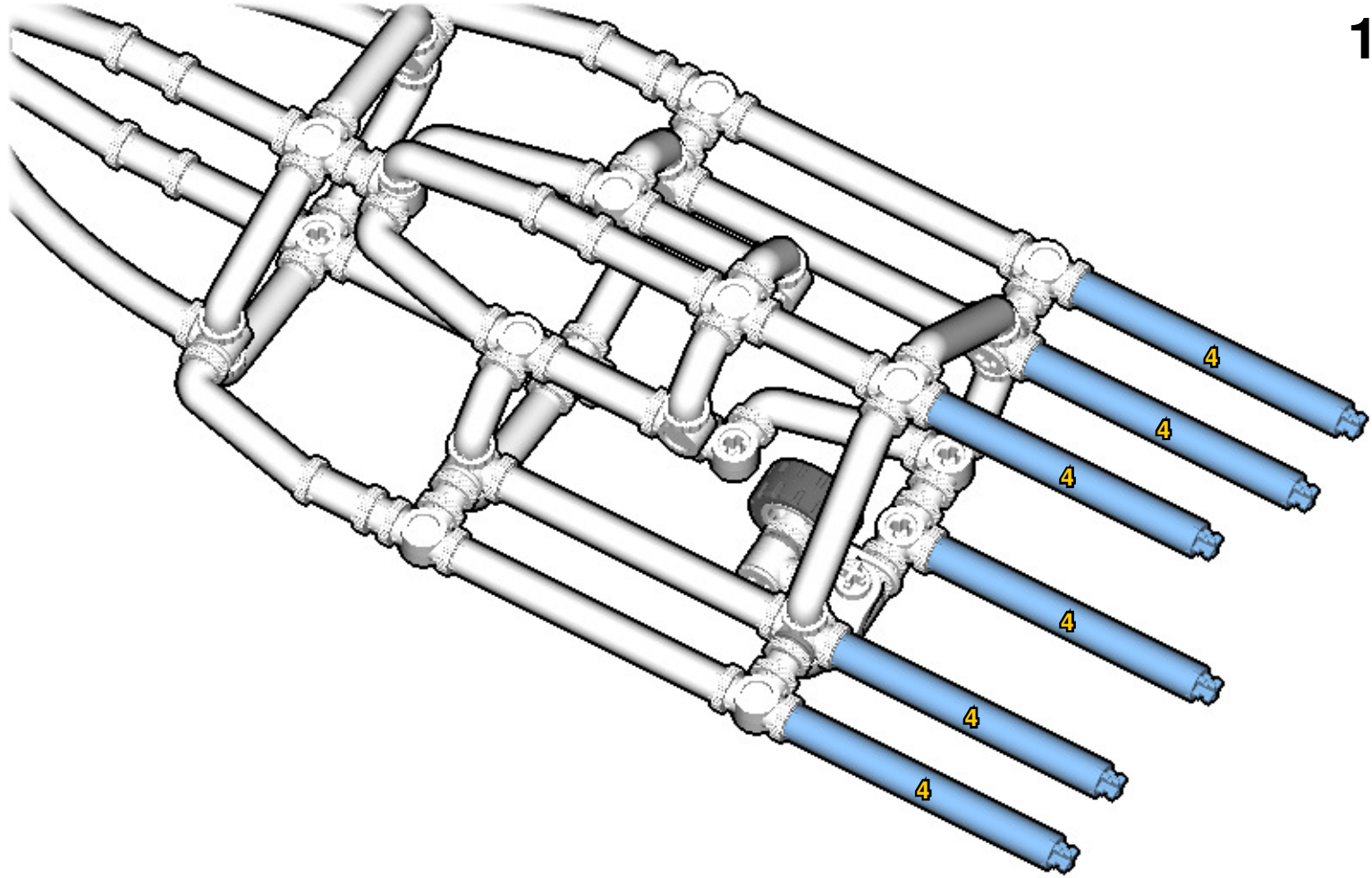

20

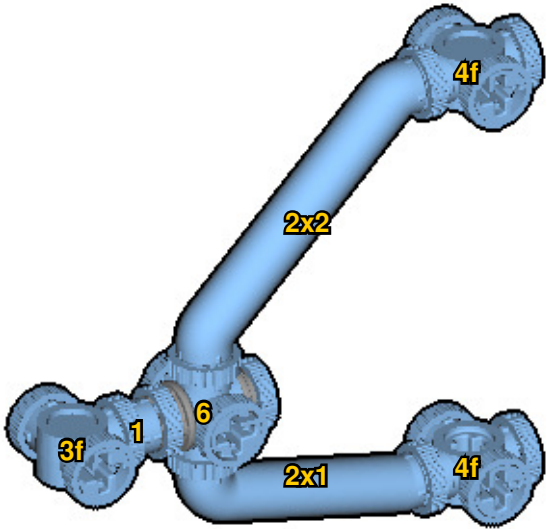

21

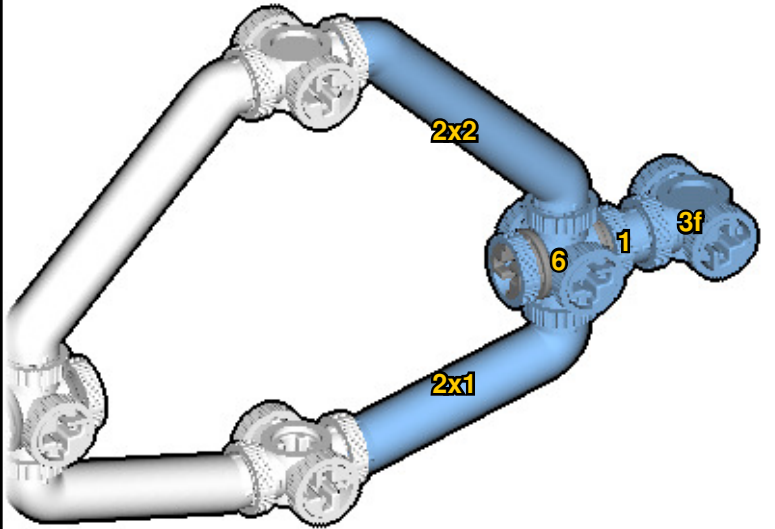

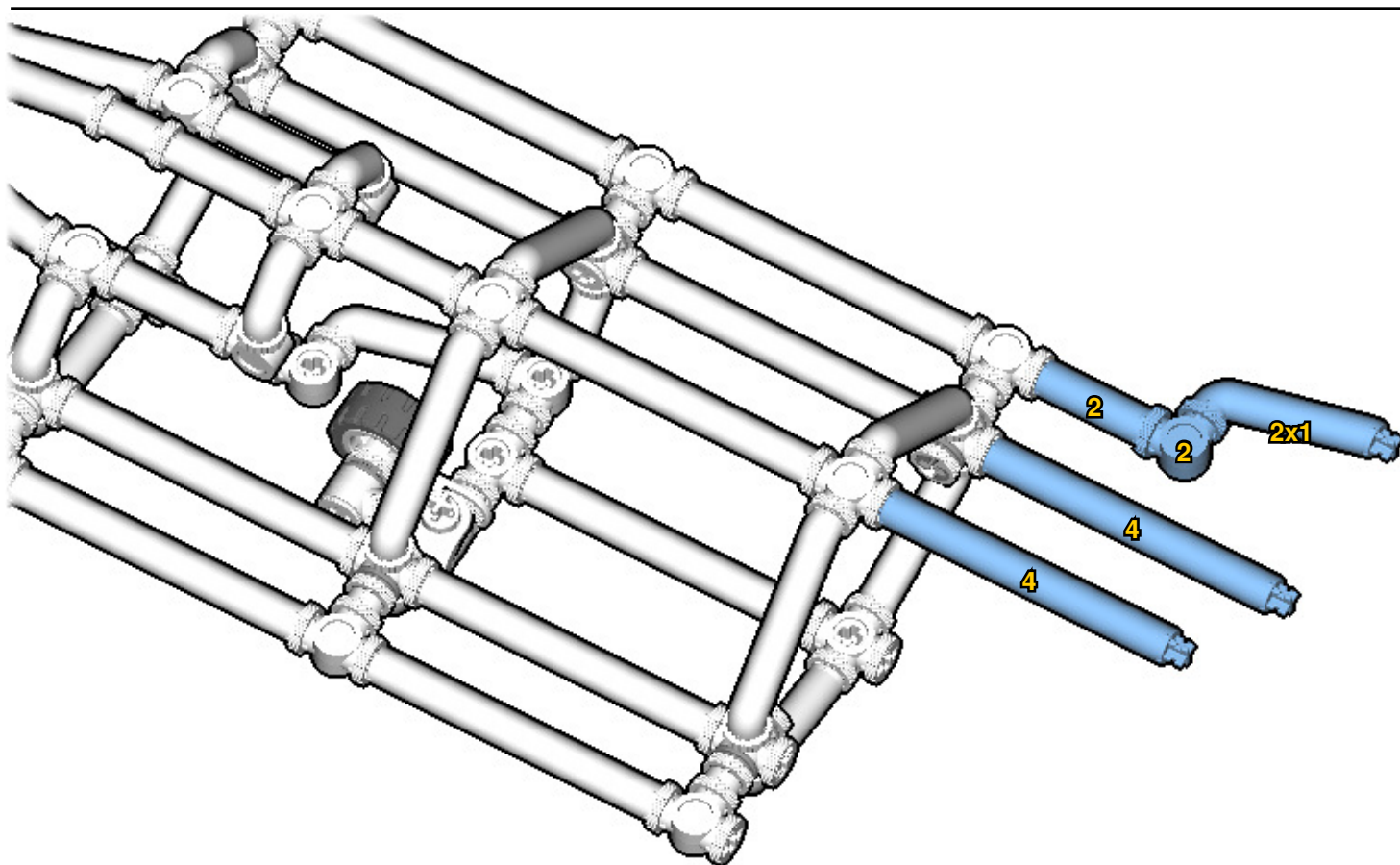
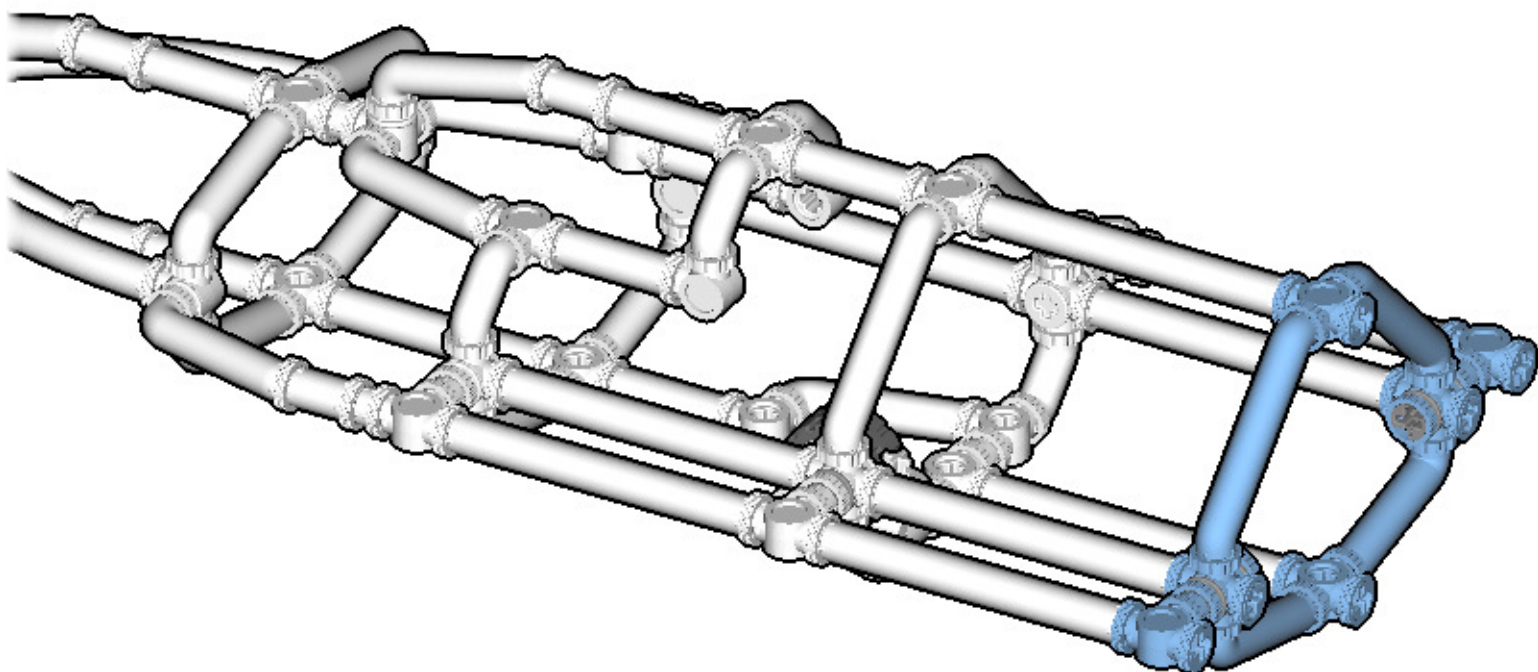

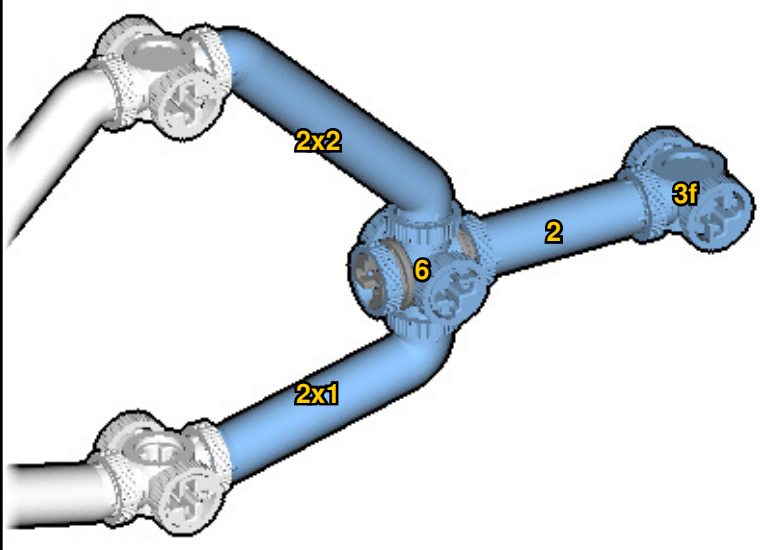
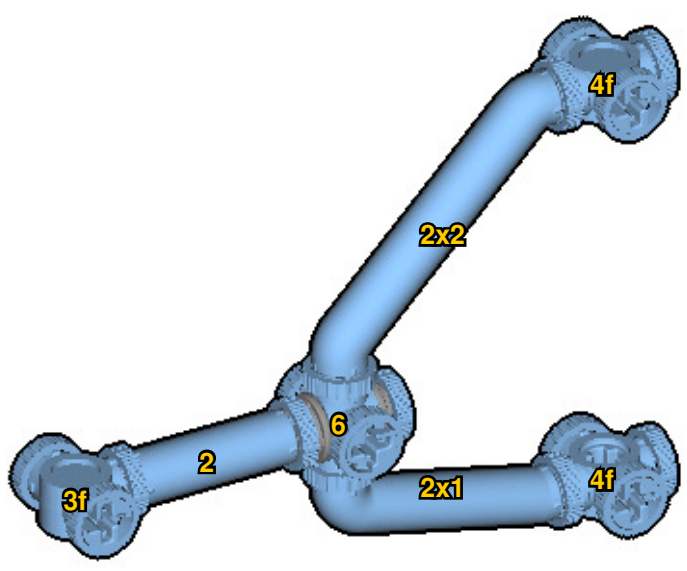
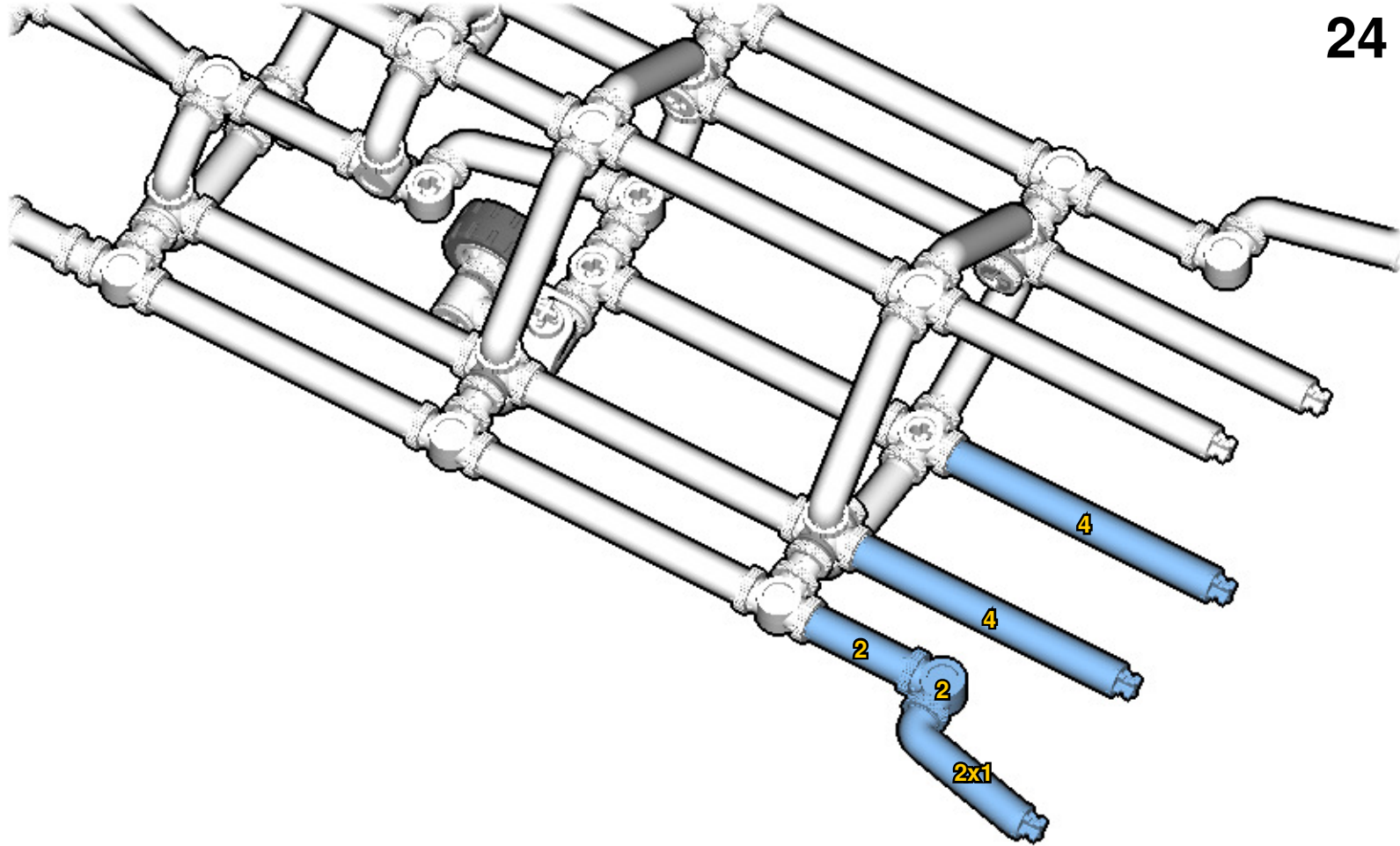

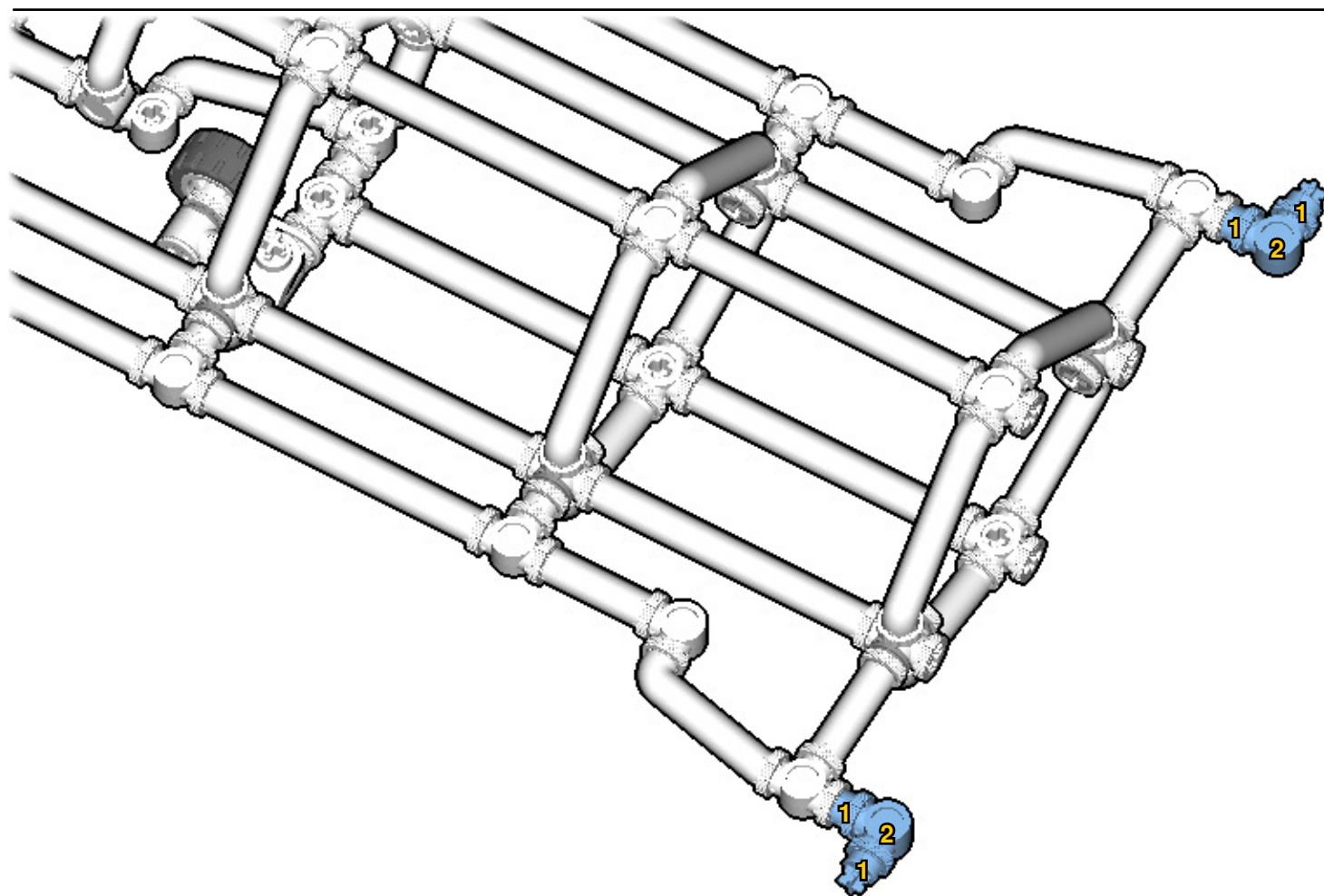
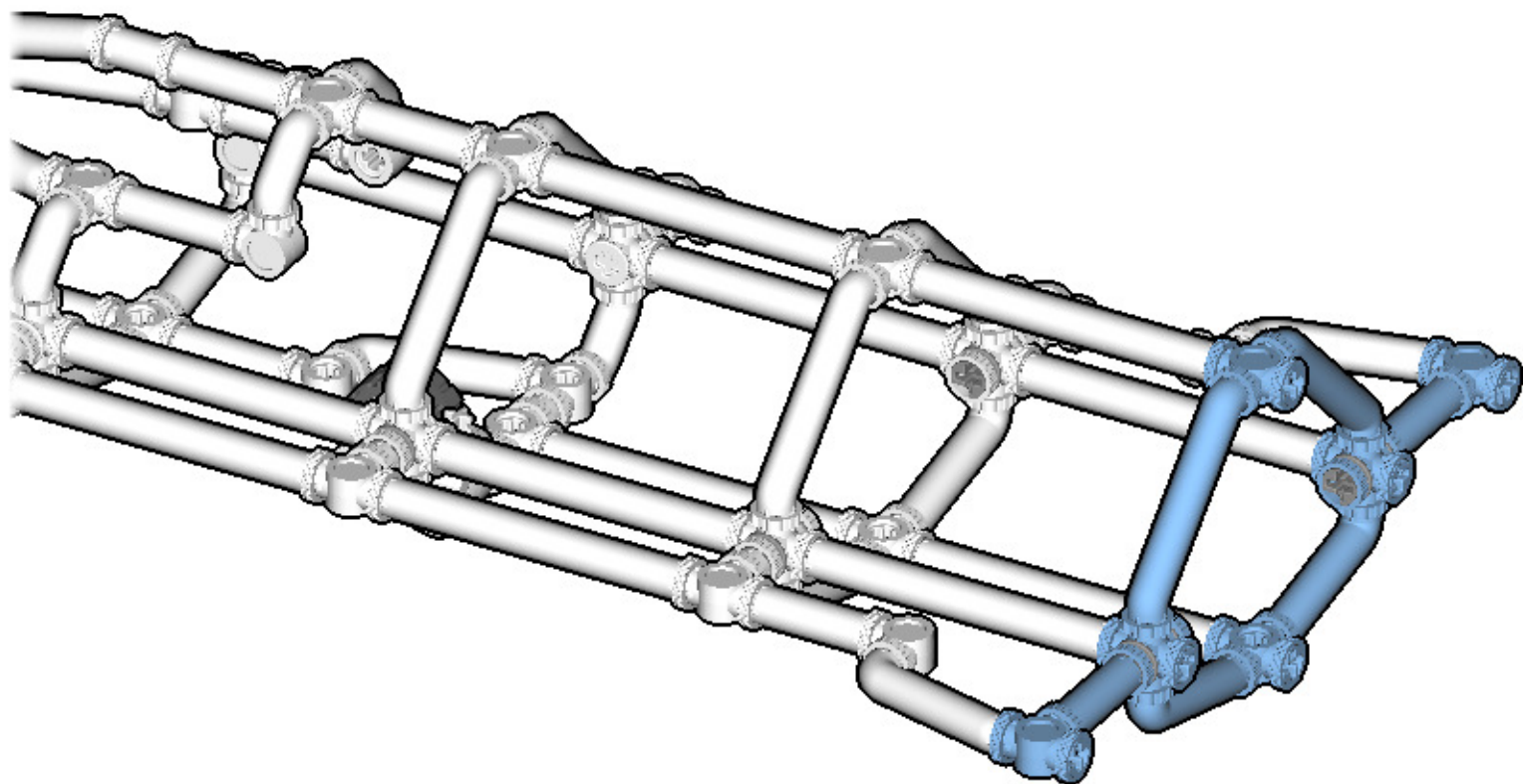

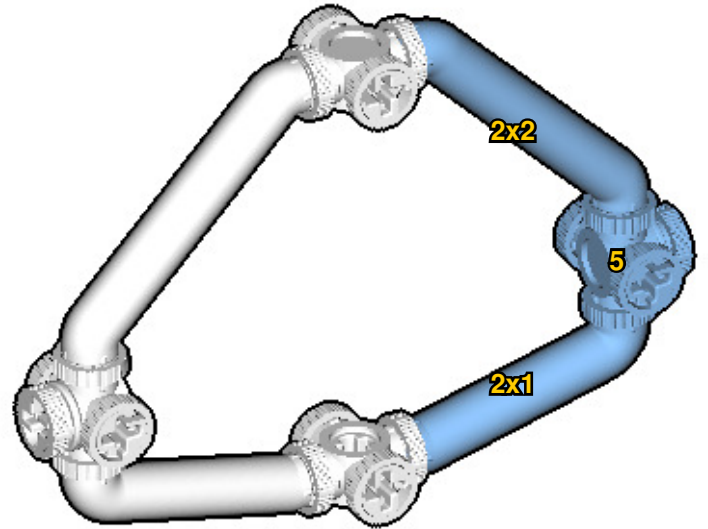
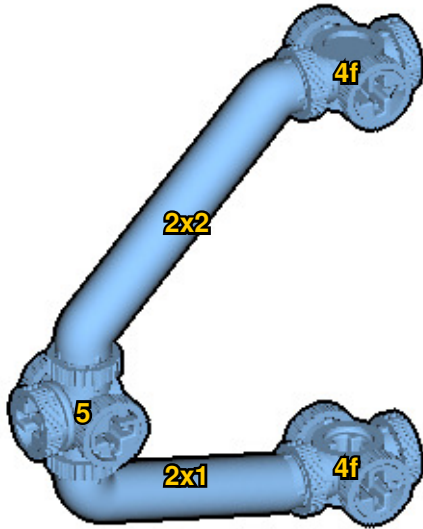
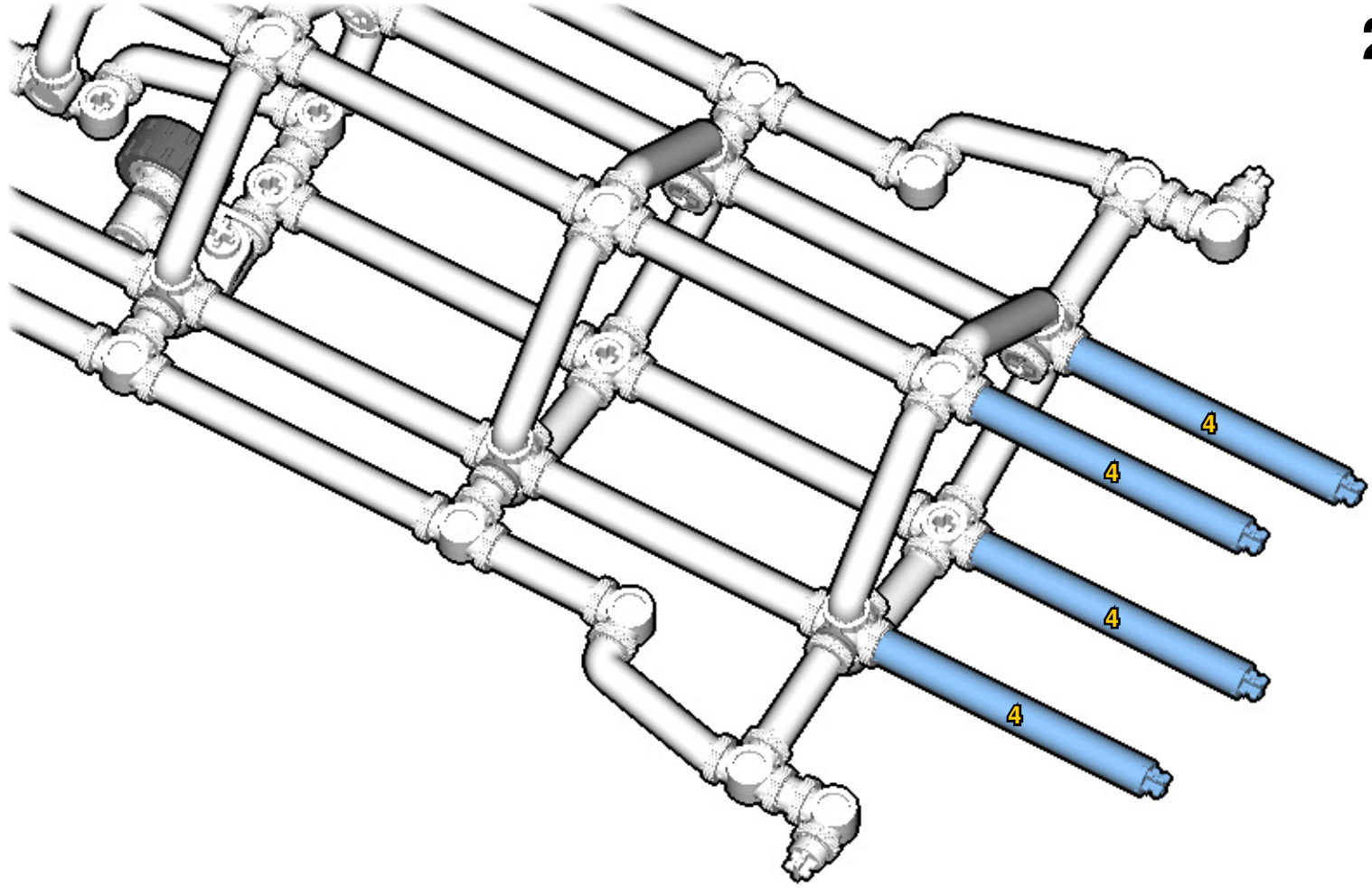

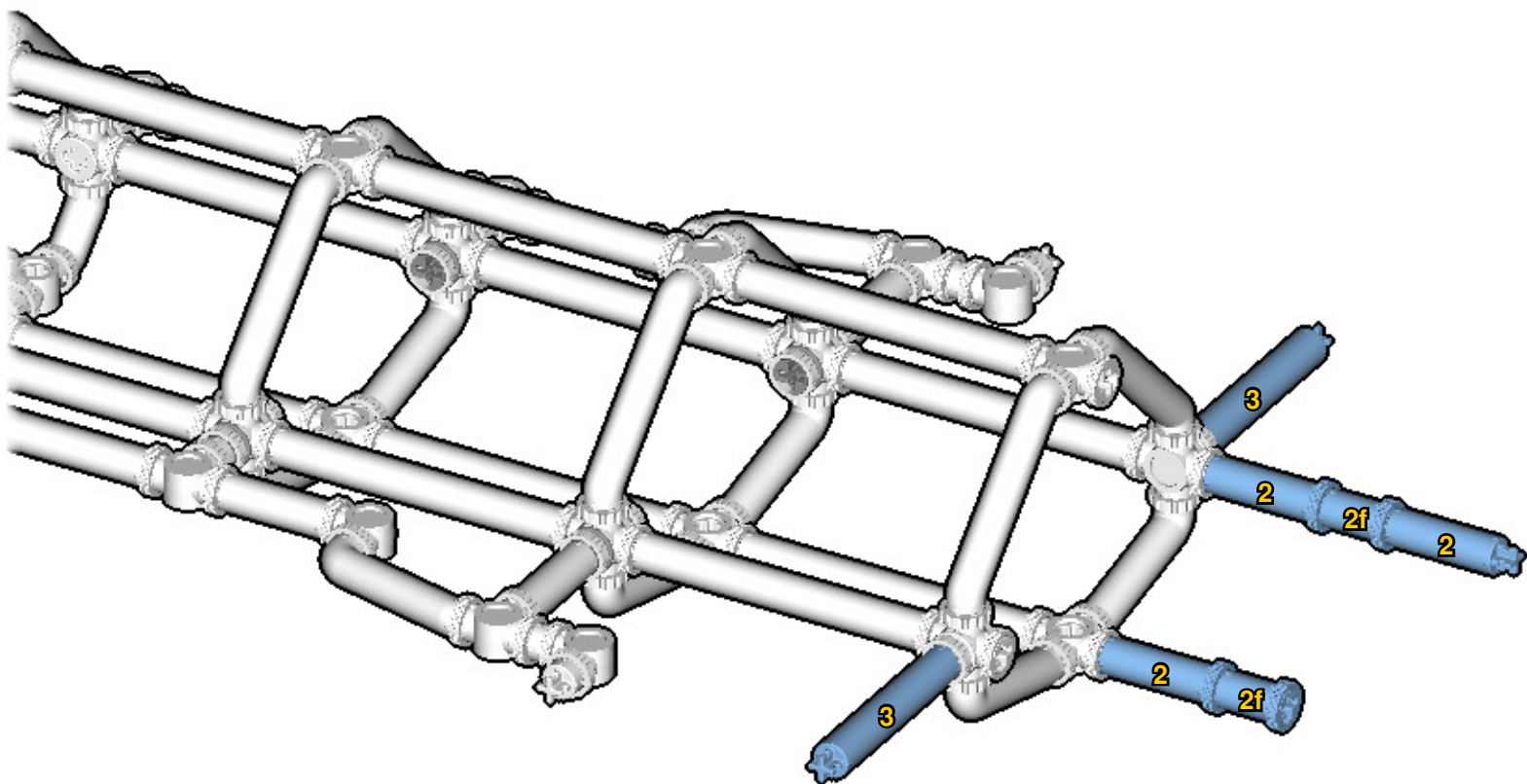
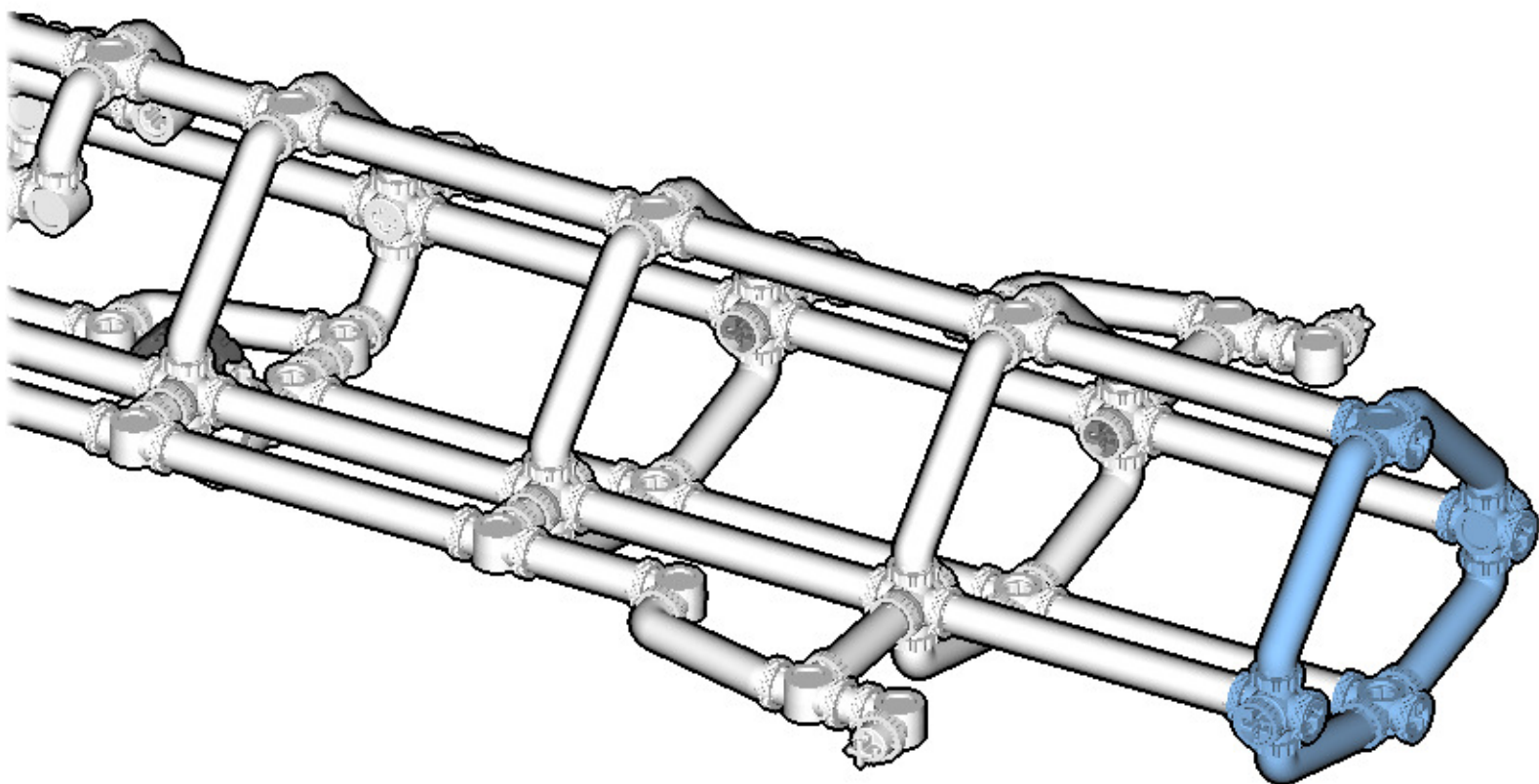

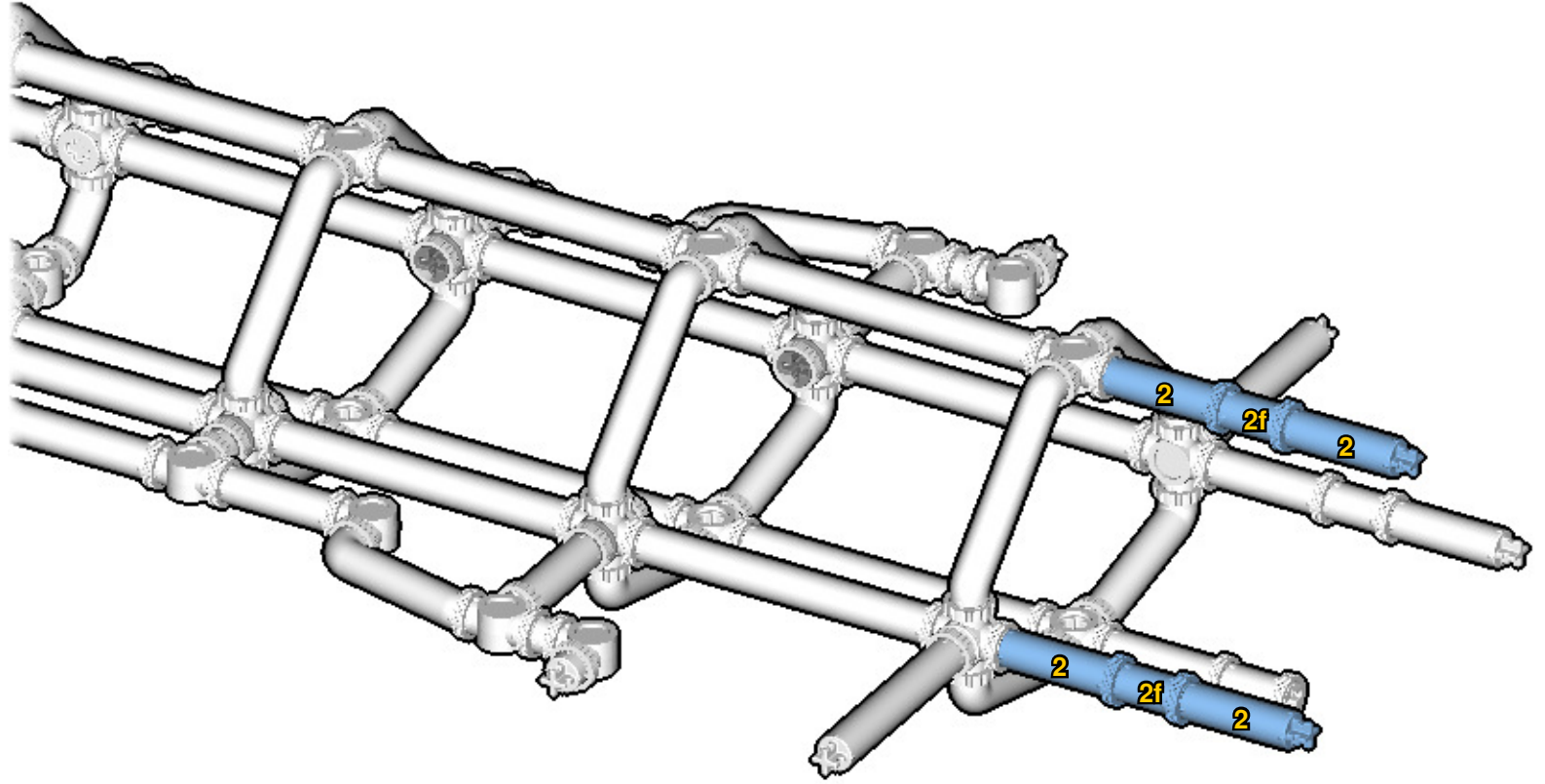
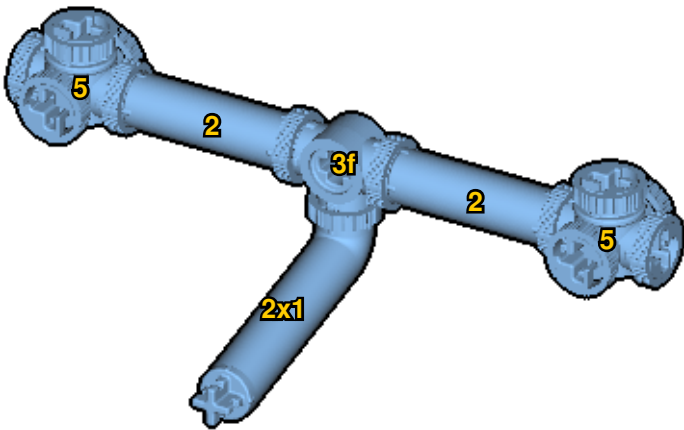
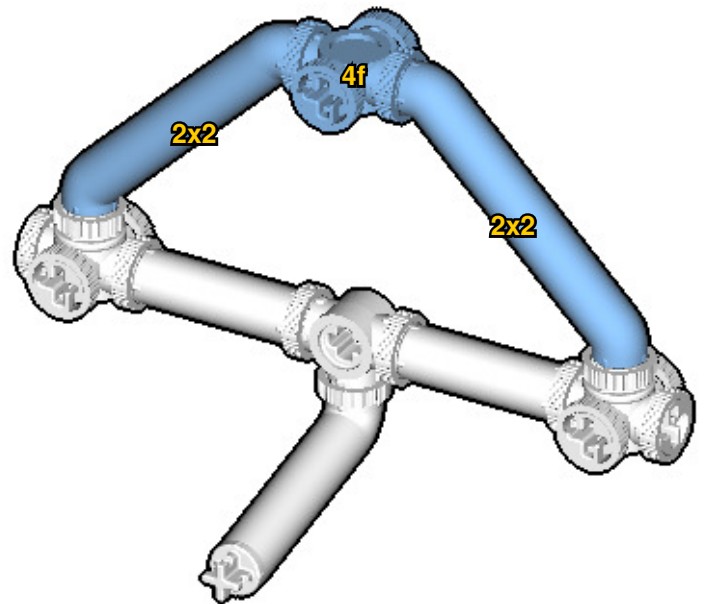
3536

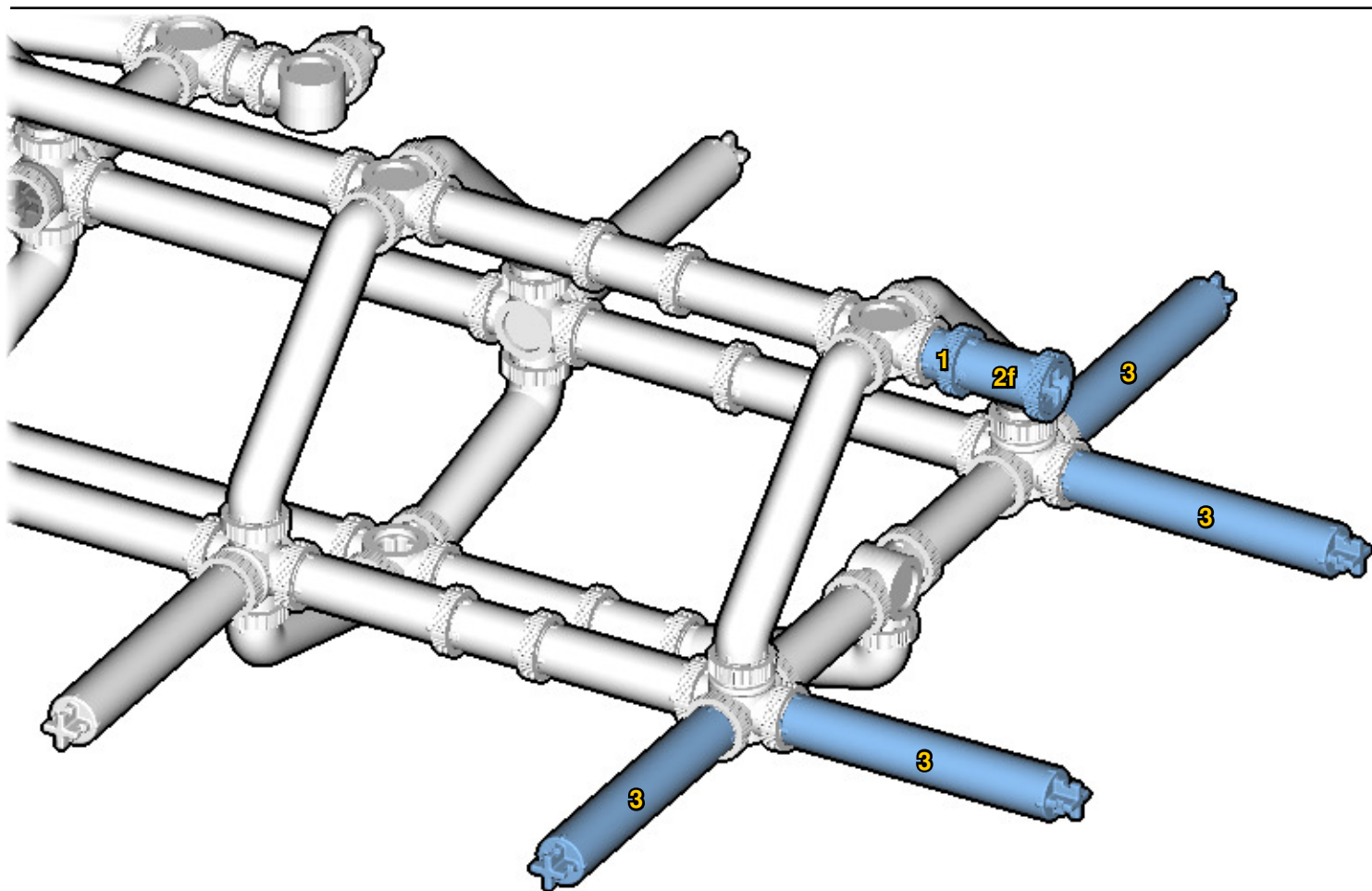
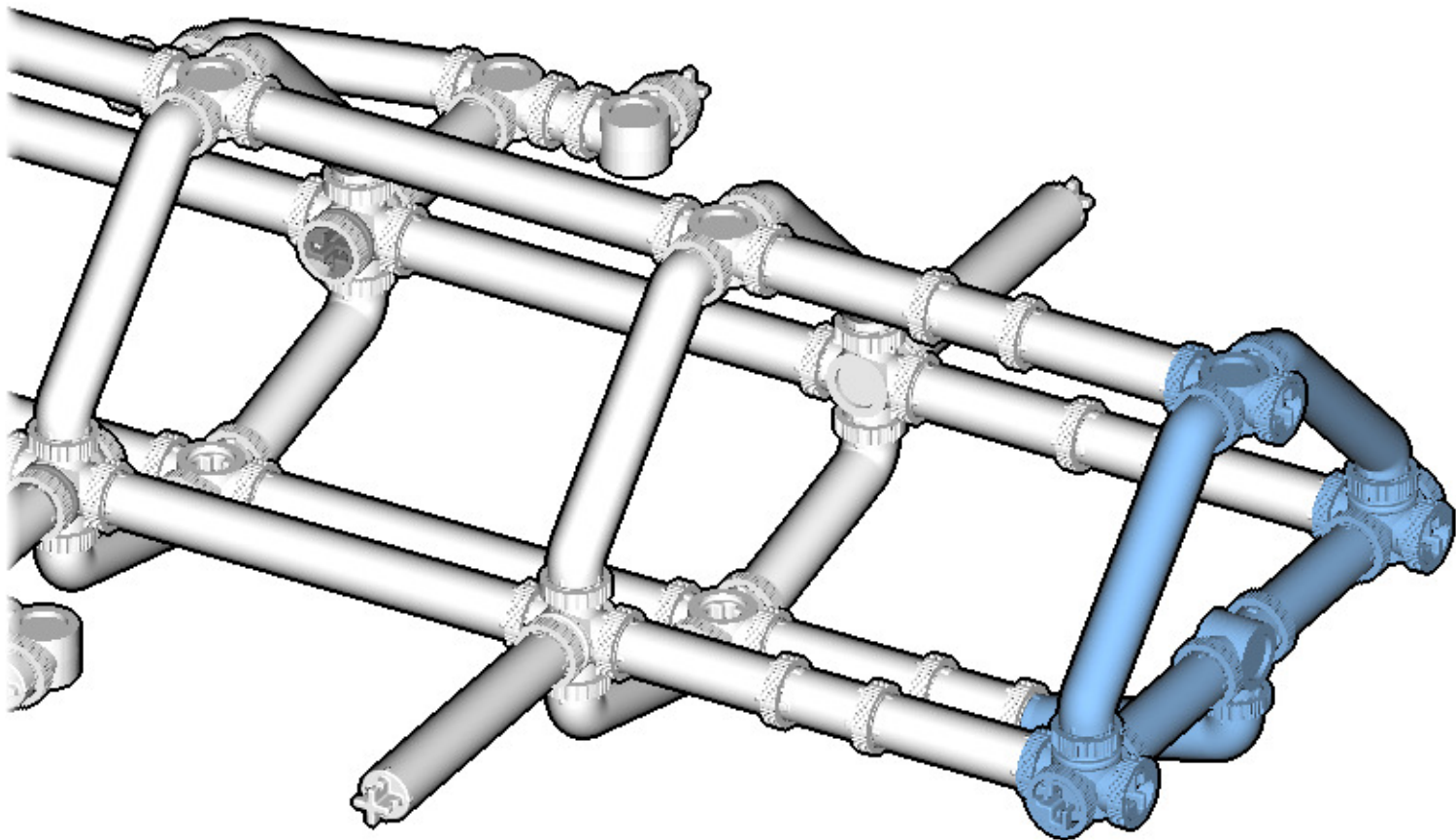

39

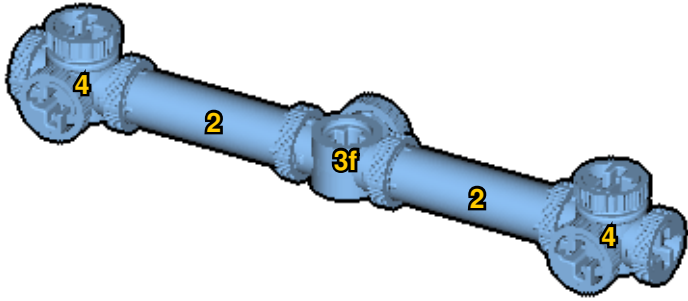

40

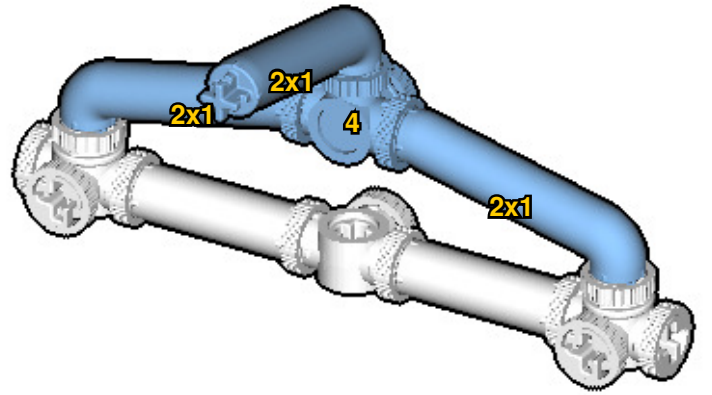

41

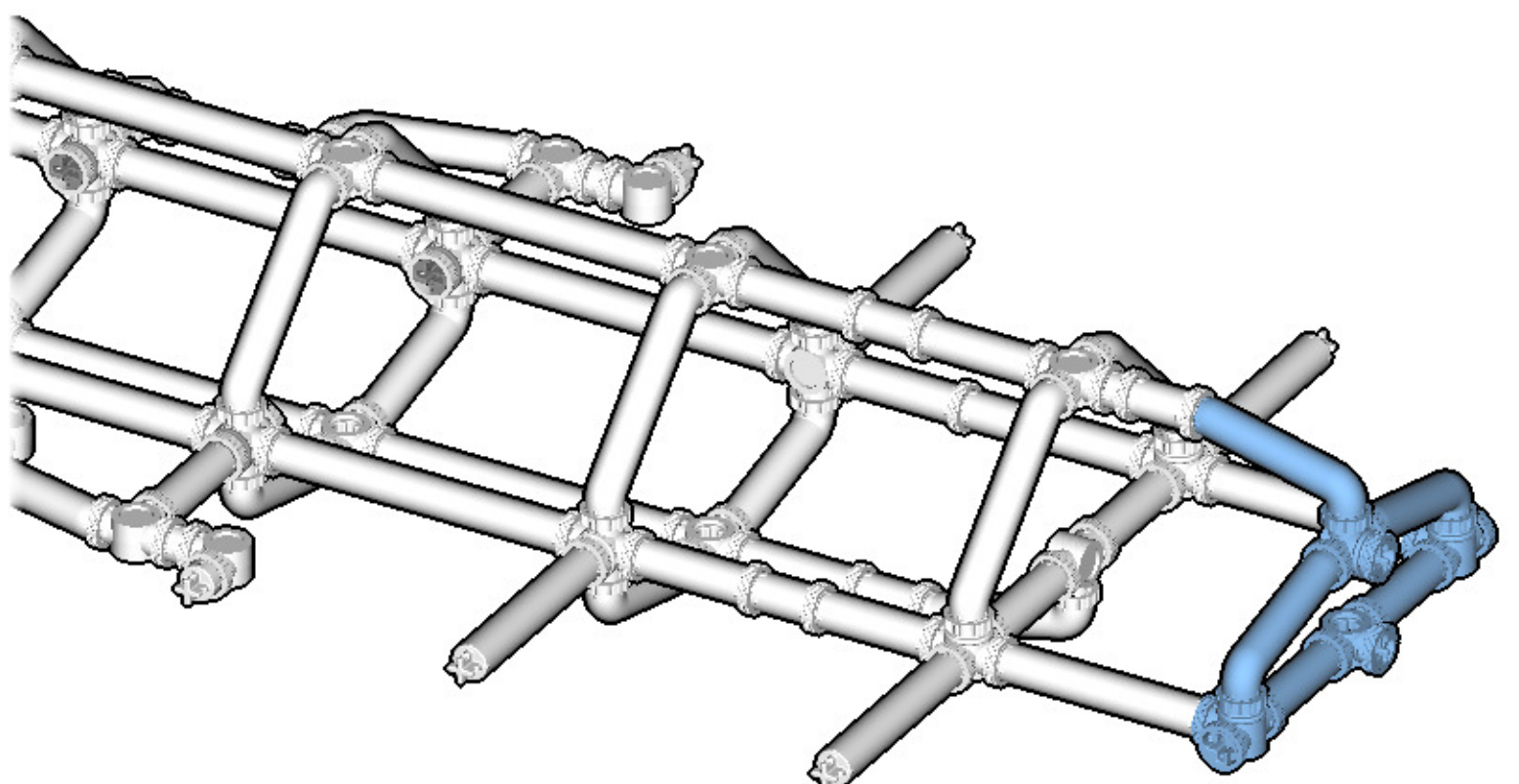

42

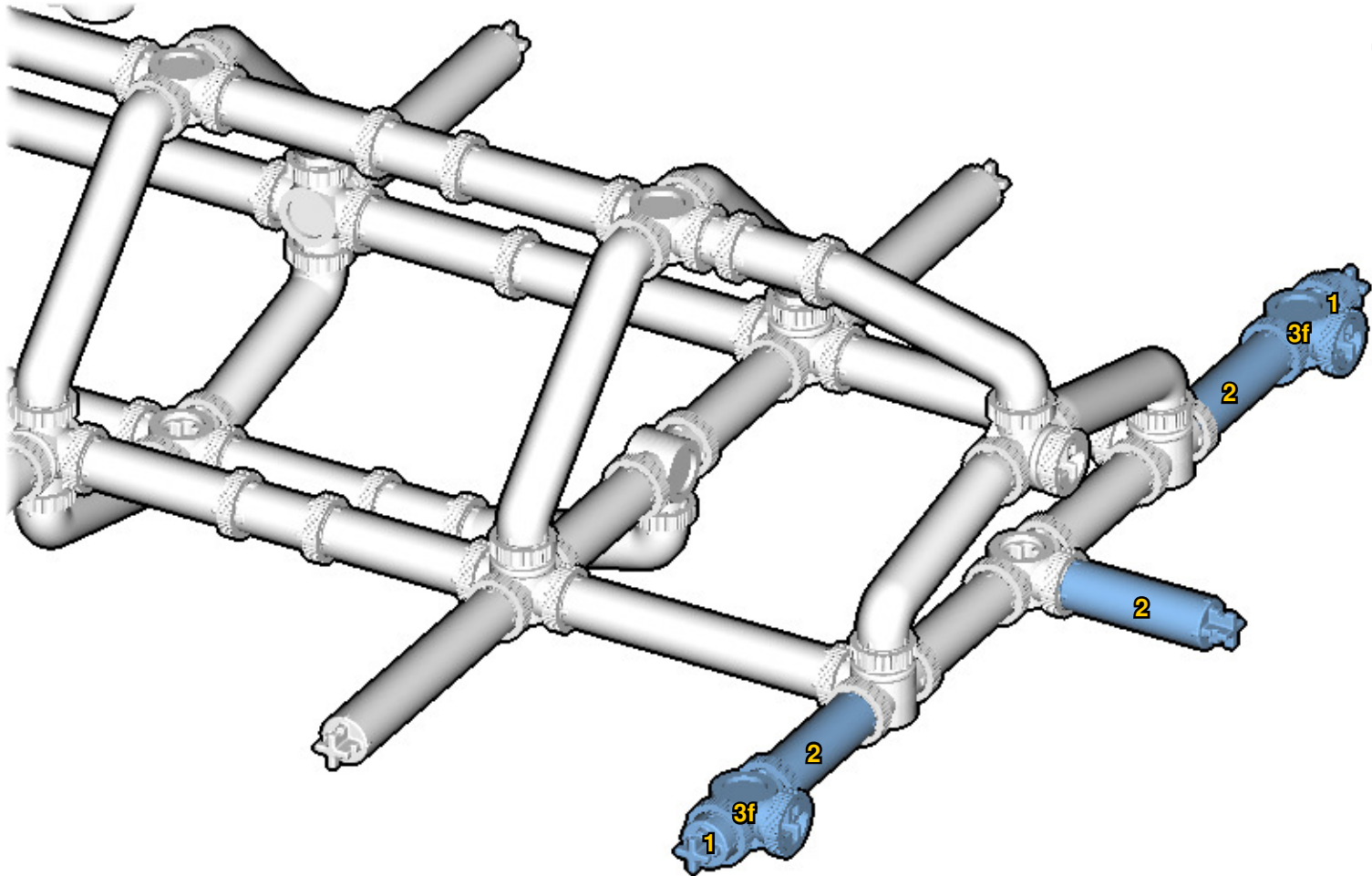

43

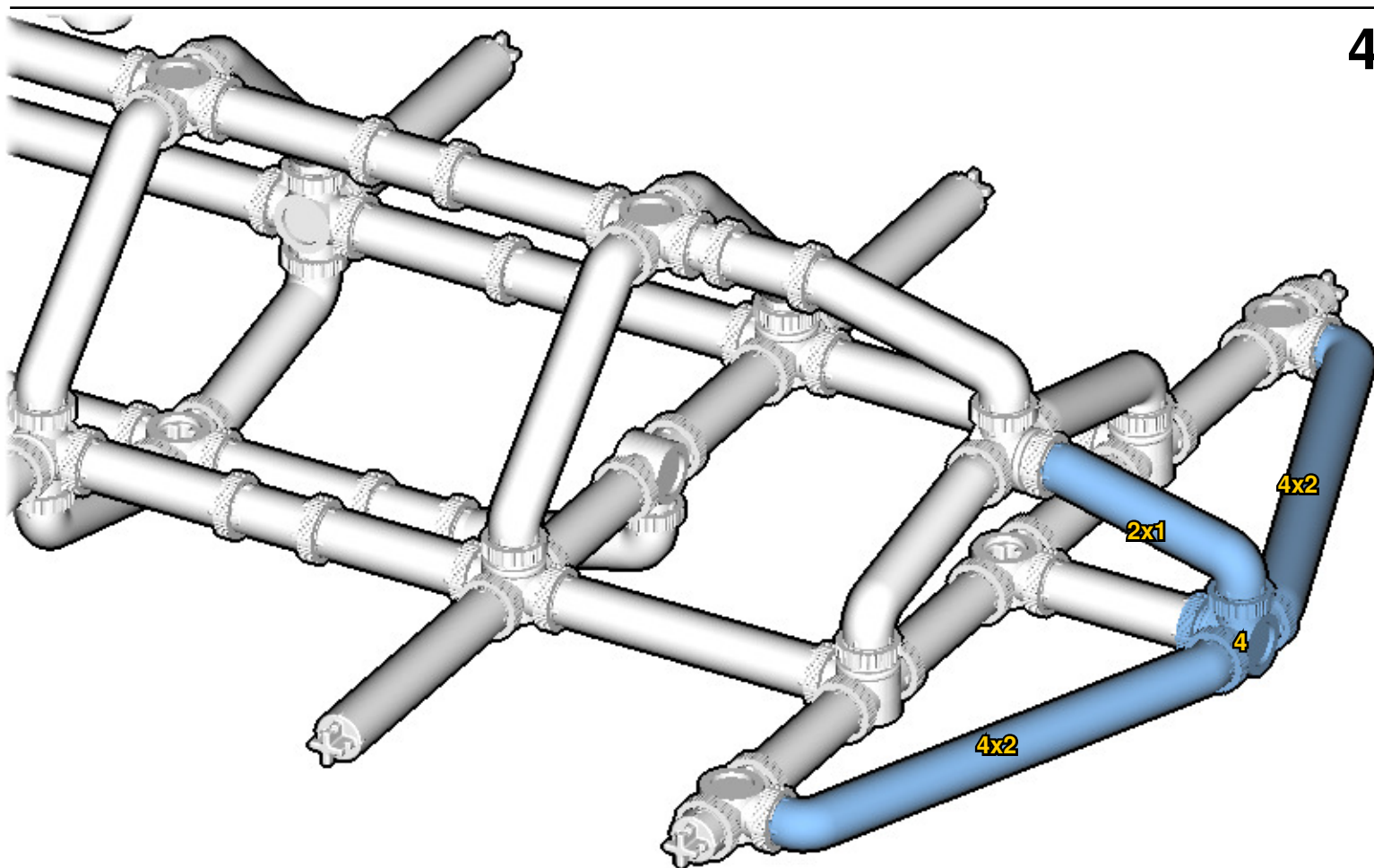

44

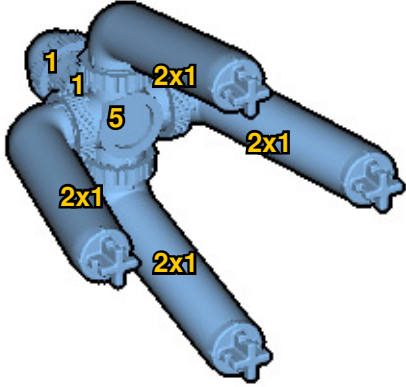

45



46

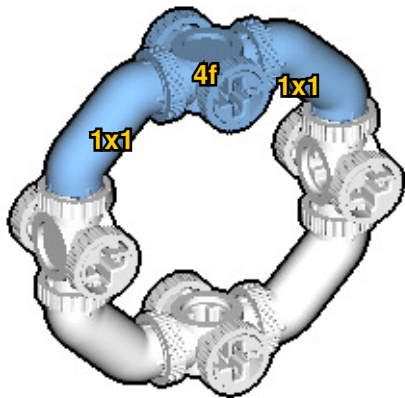

47

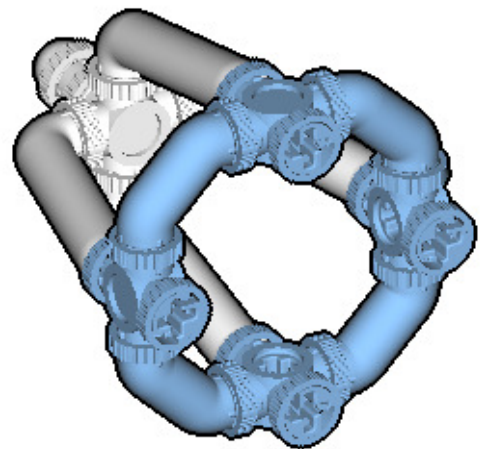

48

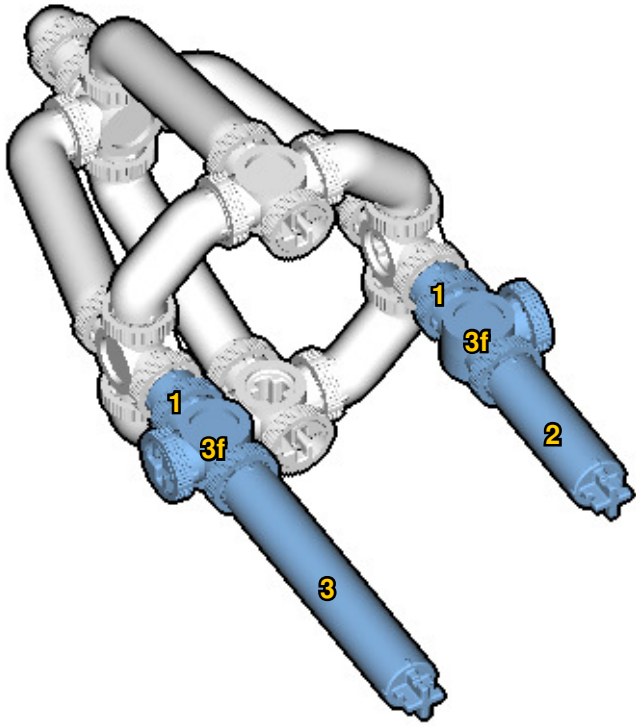

49

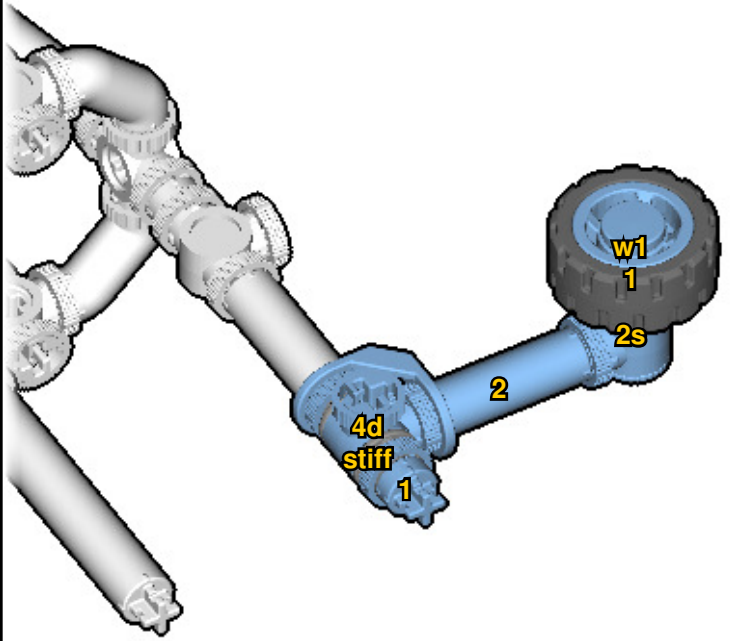

50

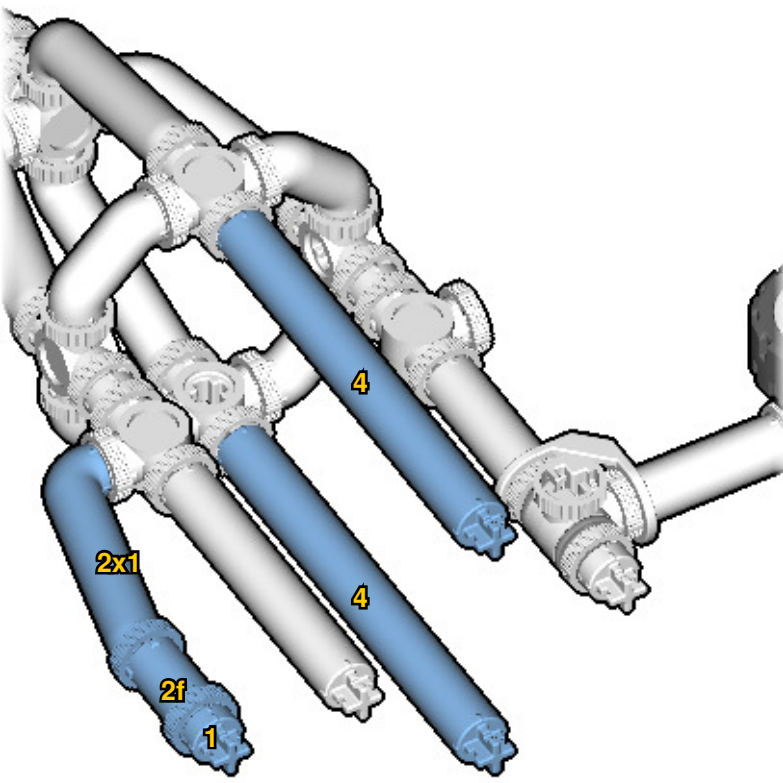

51

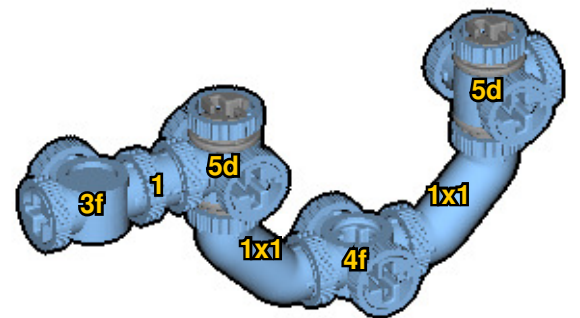

52

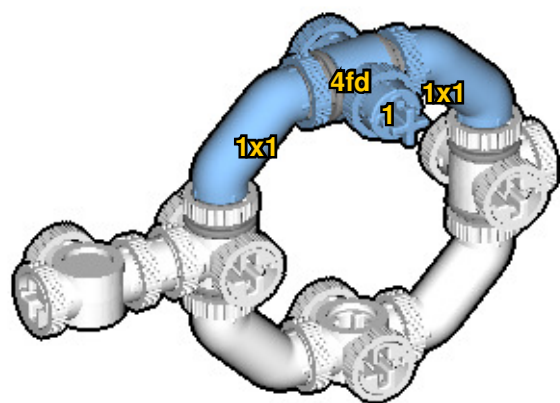

53

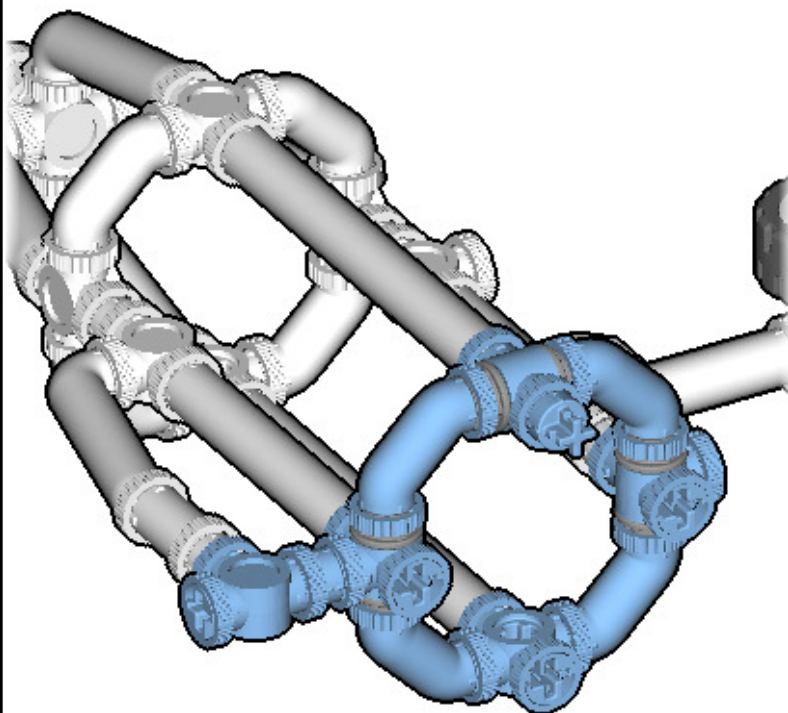

54

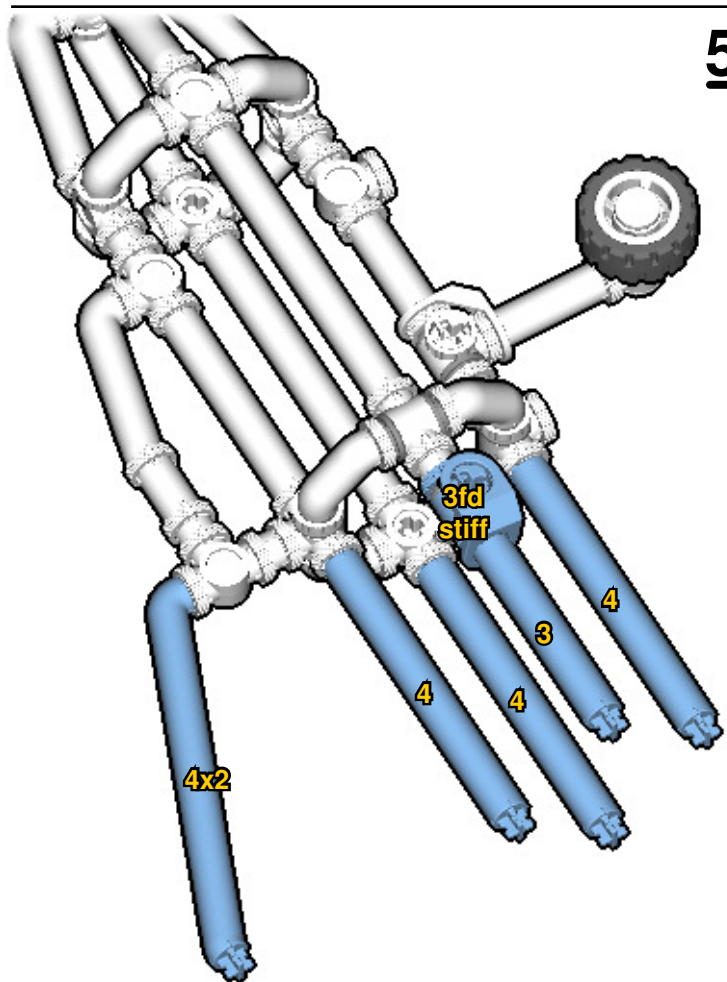

55

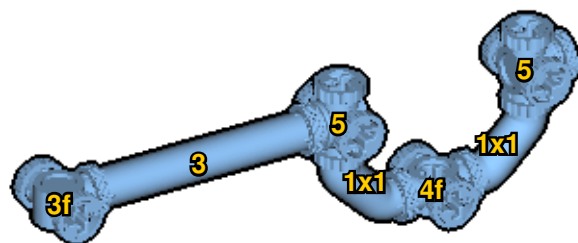

56

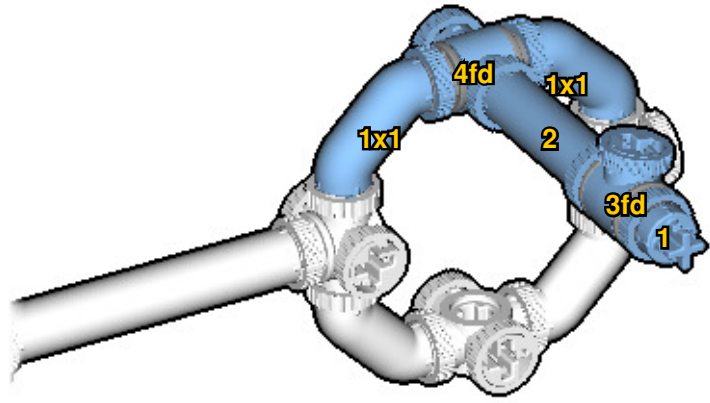

57

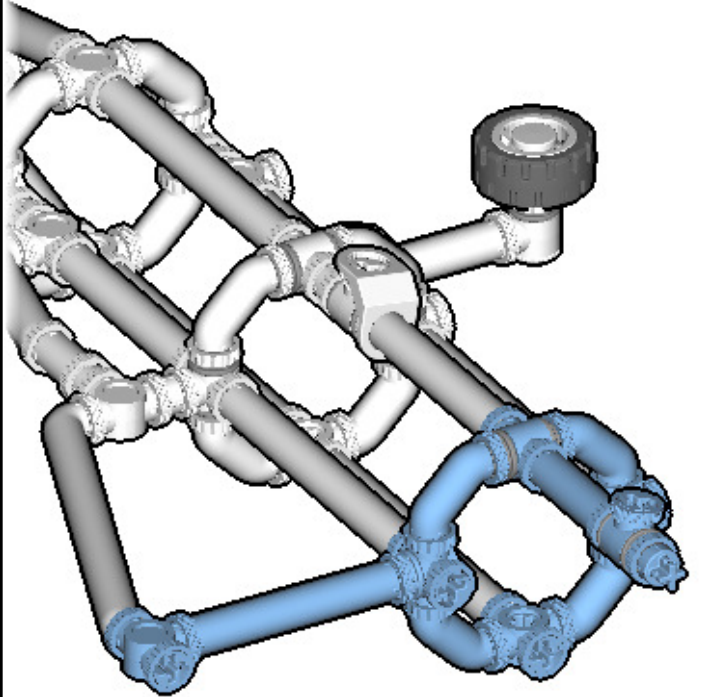

58

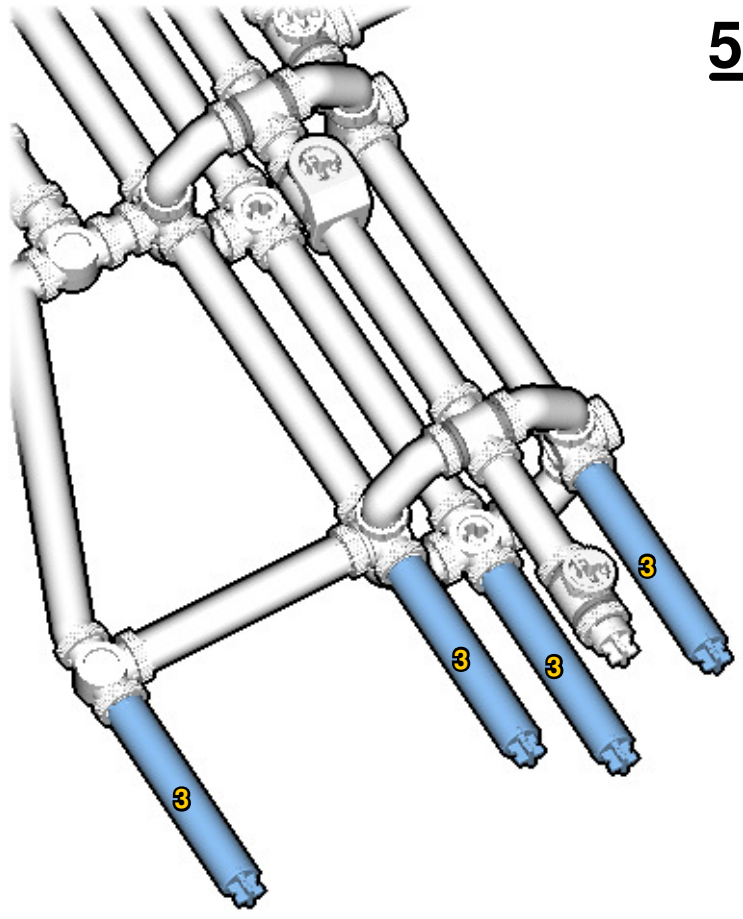

59

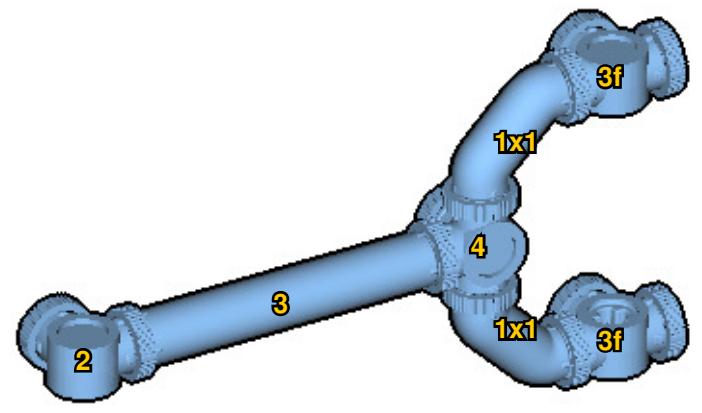

60

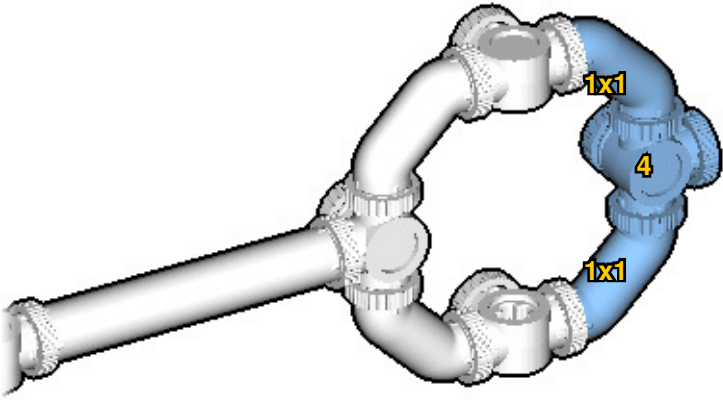

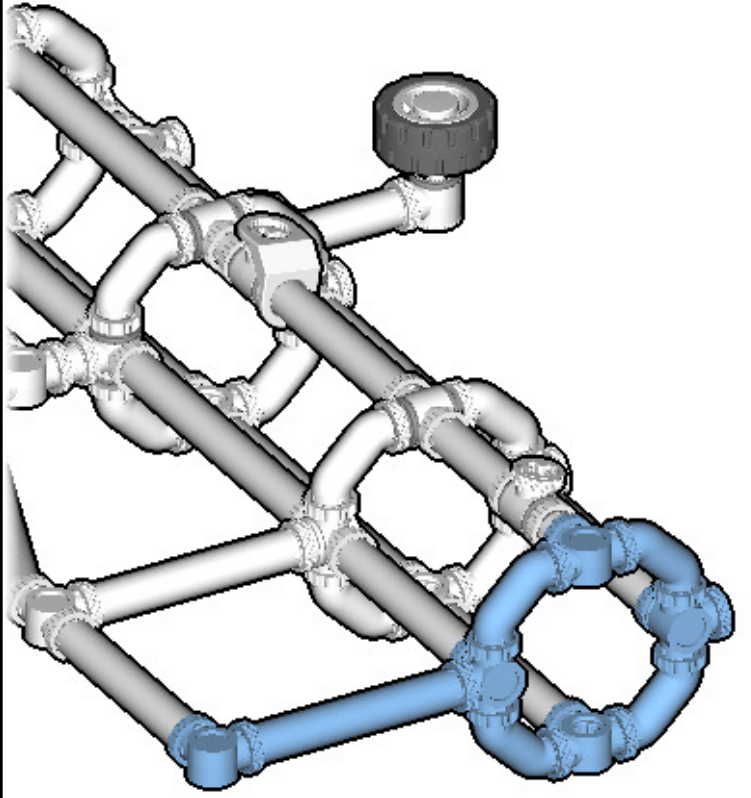

61

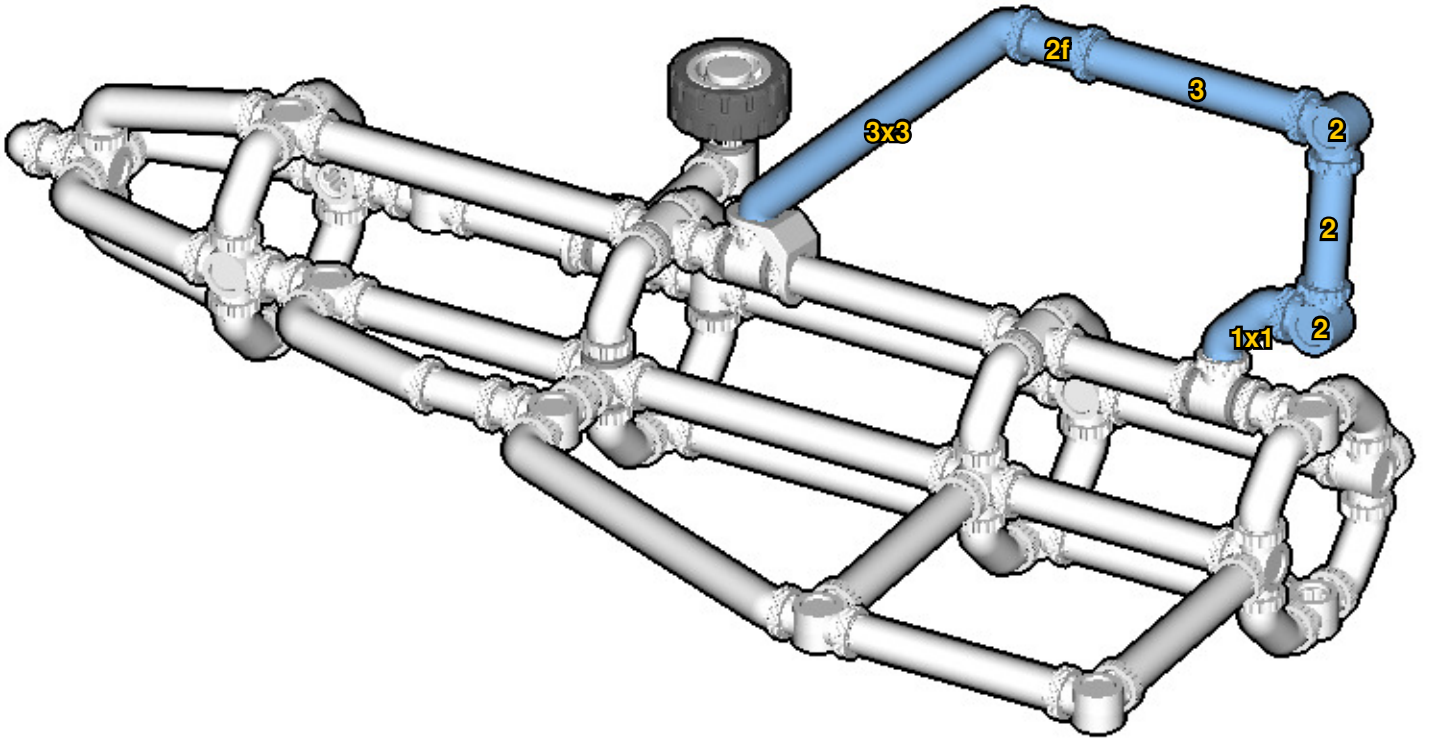

62

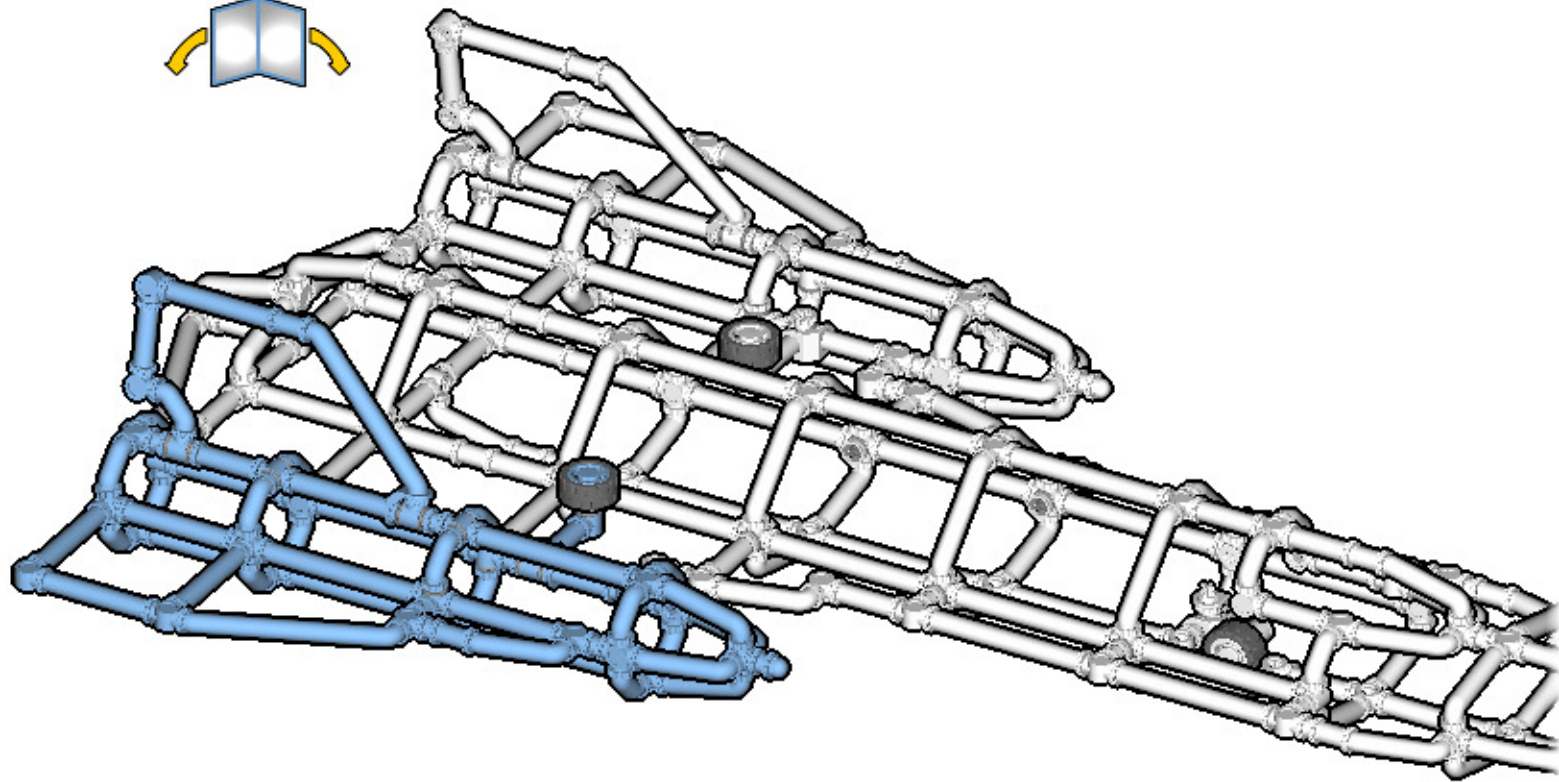
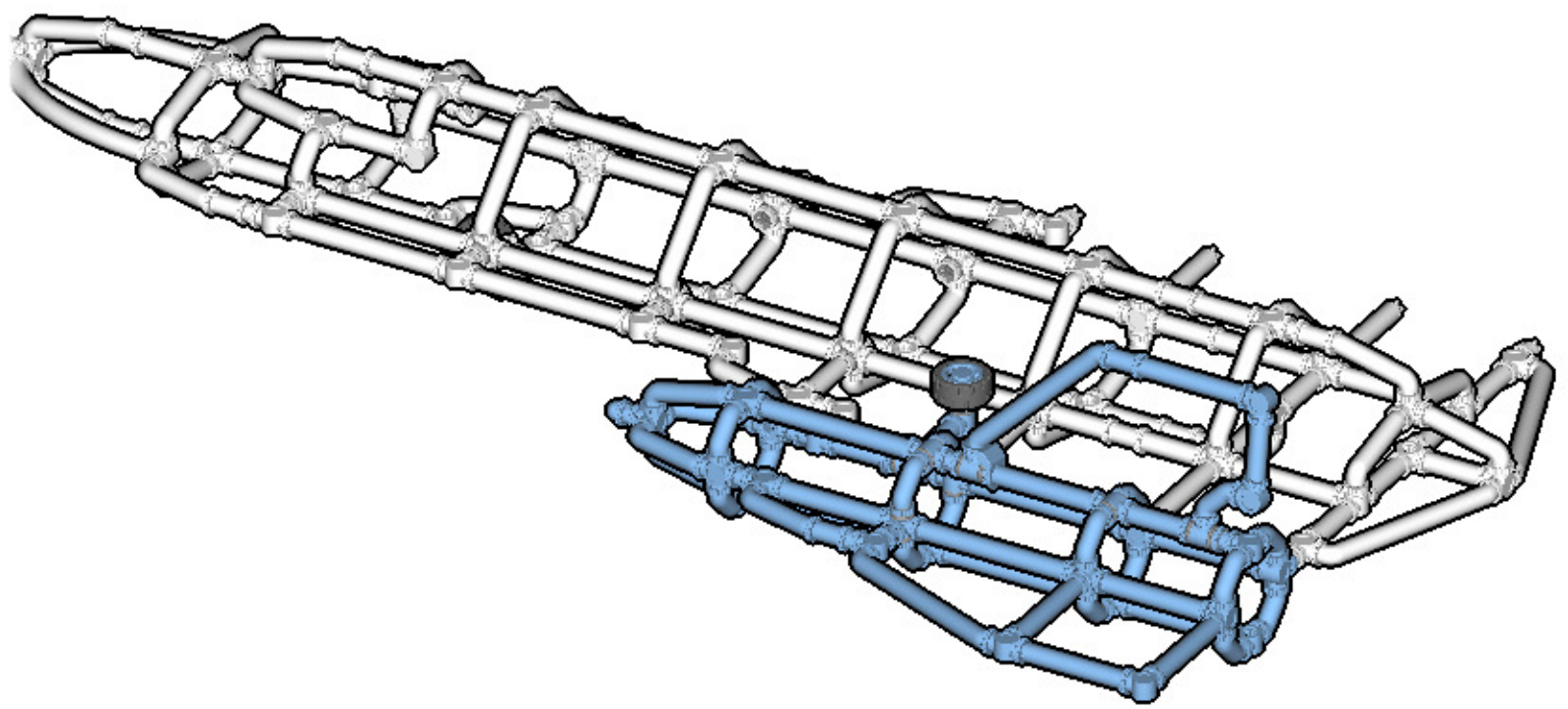



 : Copy new pieces from old pieces.

INVENTORY

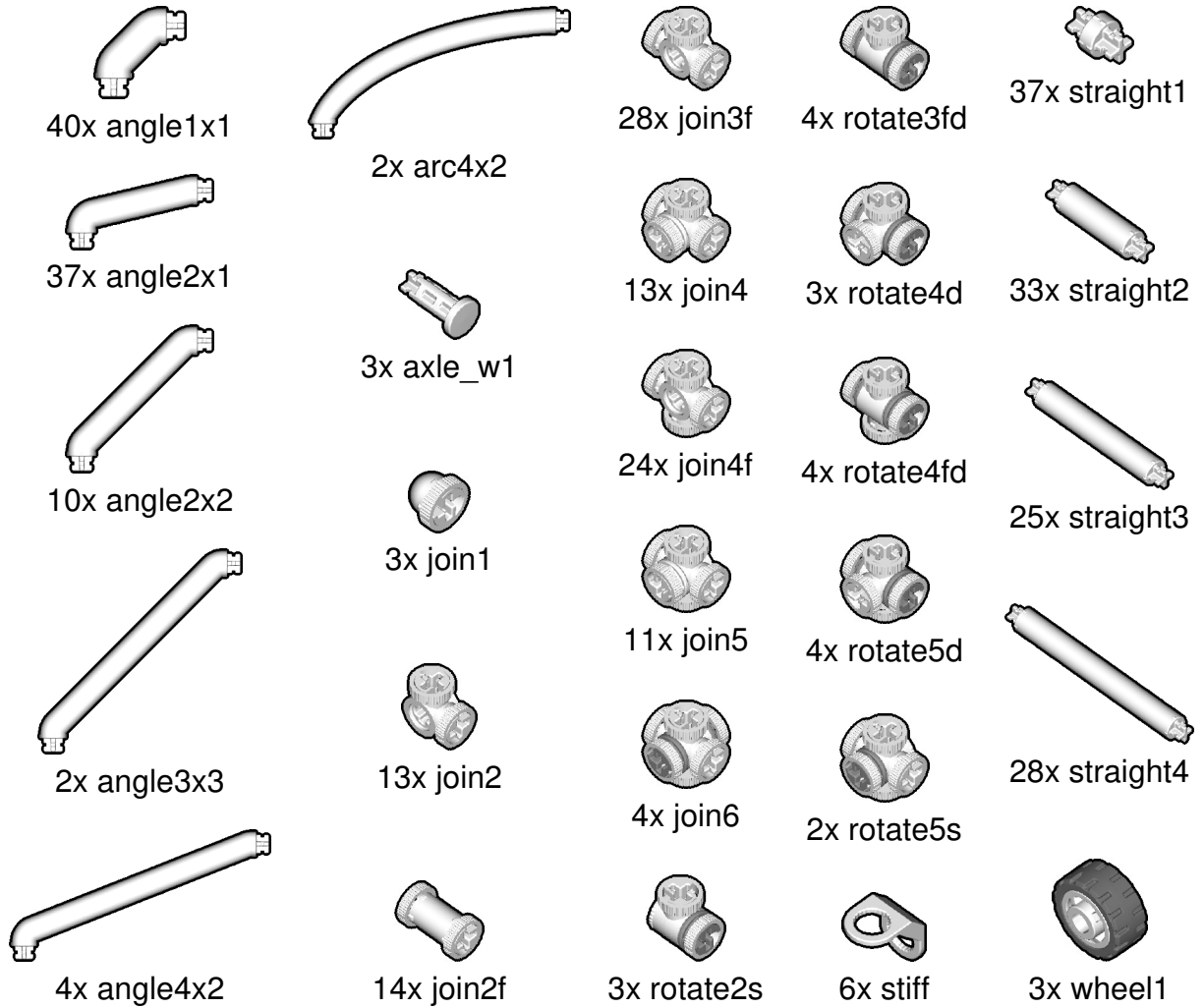

ACTUAL SIZE

