

SIZE	1.8ft x 1.3ft x 0.8ft	PIECES	211
DESIGNER	Derek Sharman	MADE IN	U.S.A.

SPACE SHUTTLE

⚠ WARNING: Small parts. Age 12+. Handle responsibly. U.S. Patent 9,086,087.



Wrong
Connecting/Disconnecting Two Directions

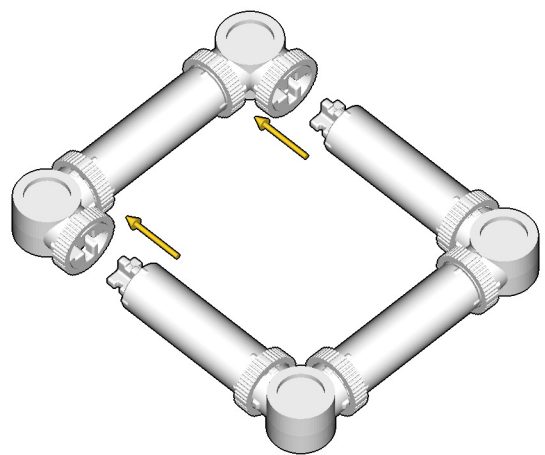

Right
Connecting/Disconnecting One Direction

1

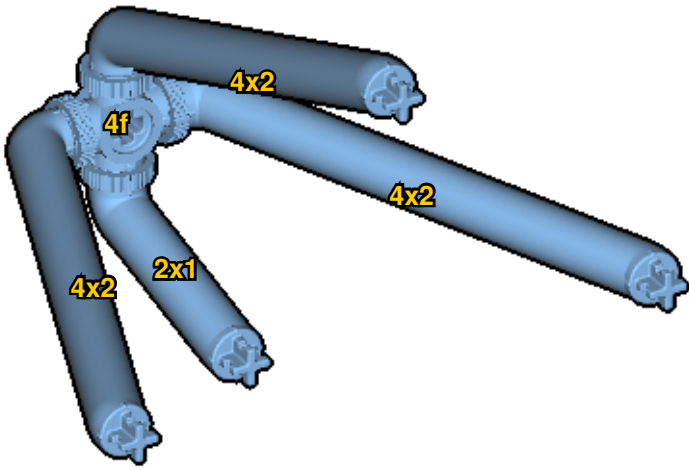

New pieces are drawn blue. Old pieces are drawn white.
See back for piece names.

2

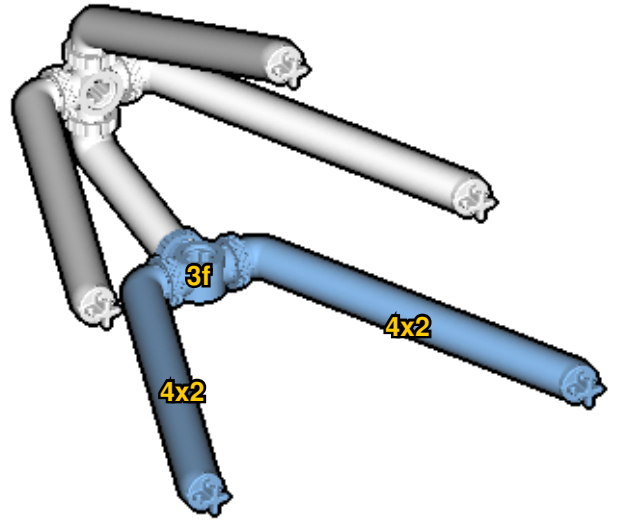

Connect new pieces together before connecting to old pieces.

3

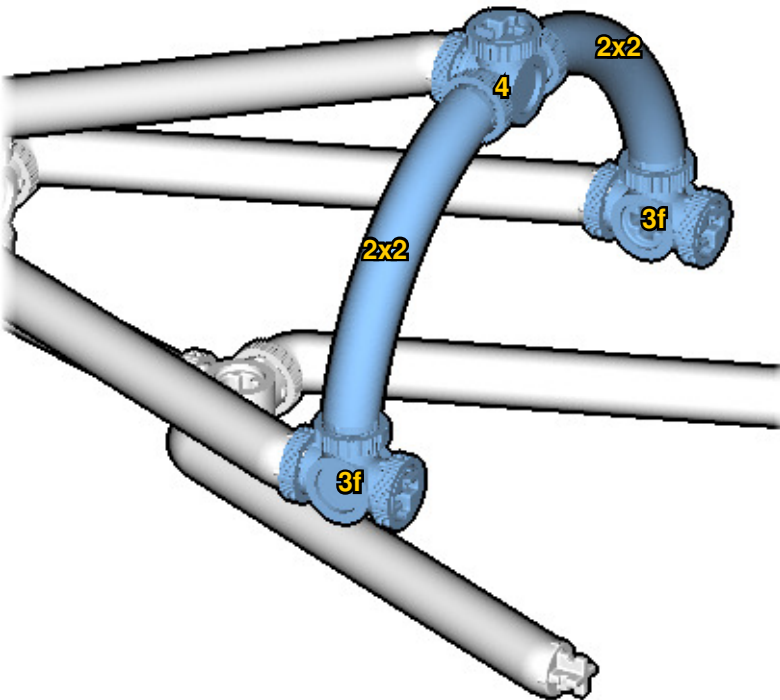

4

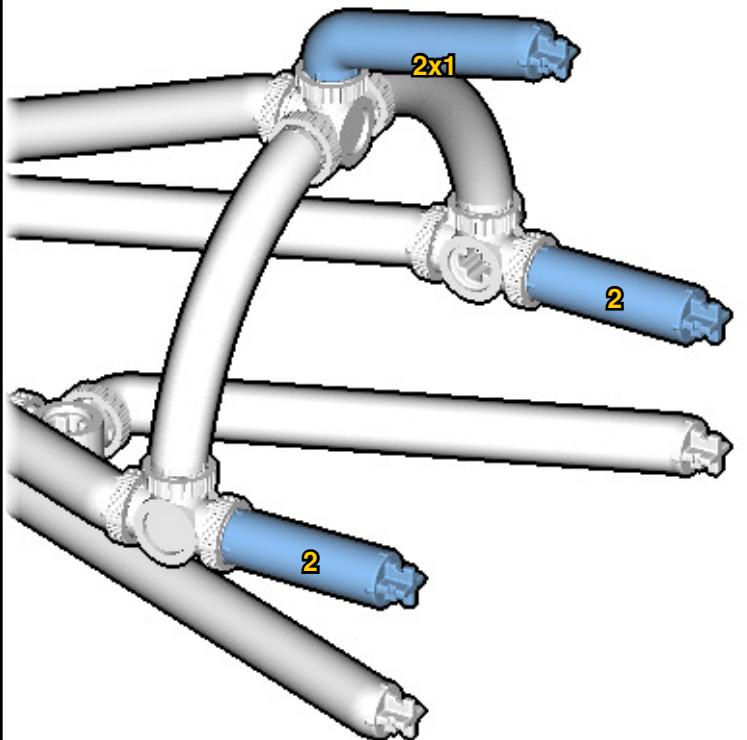

Submodel begins → **5**

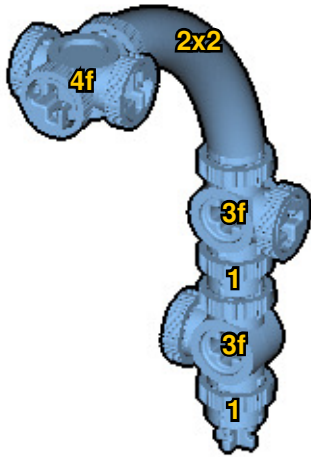

6

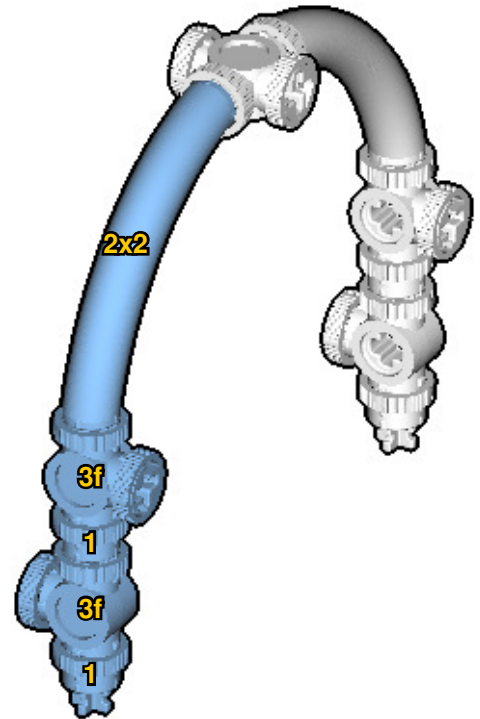

7

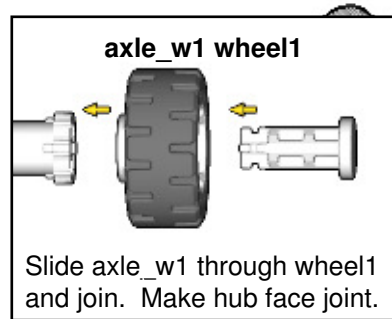
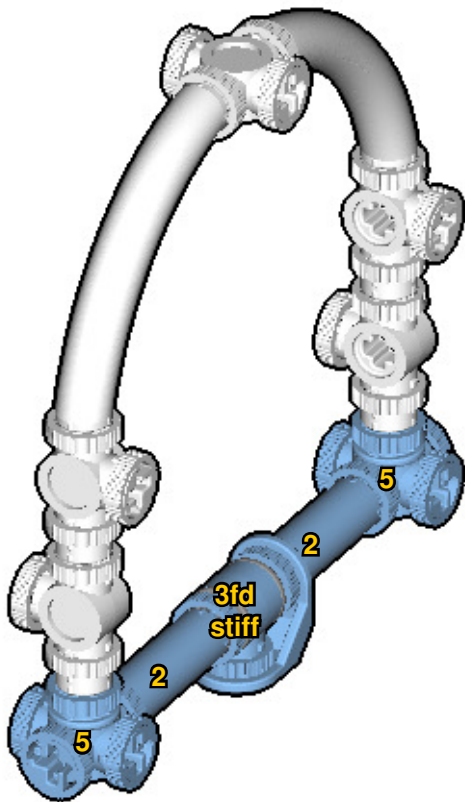

axle_w1 wheel1

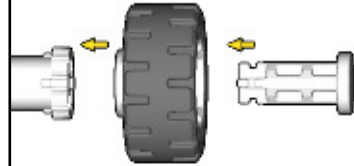

Slide axle_w1 through wheel1 and join. Make hub face joint.

8

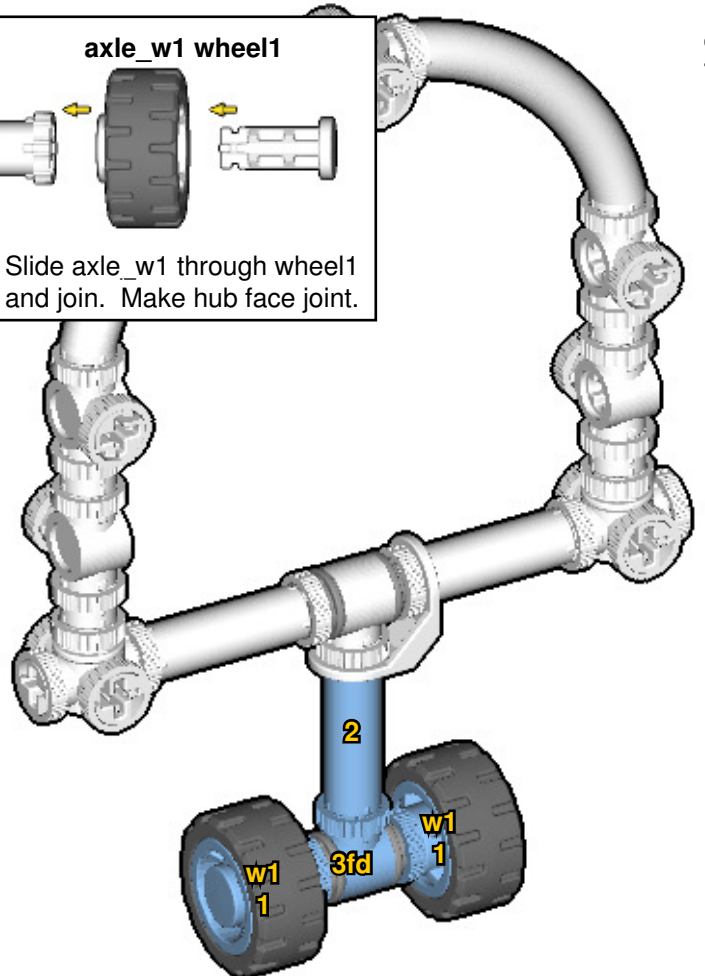

9

Submodel ends →

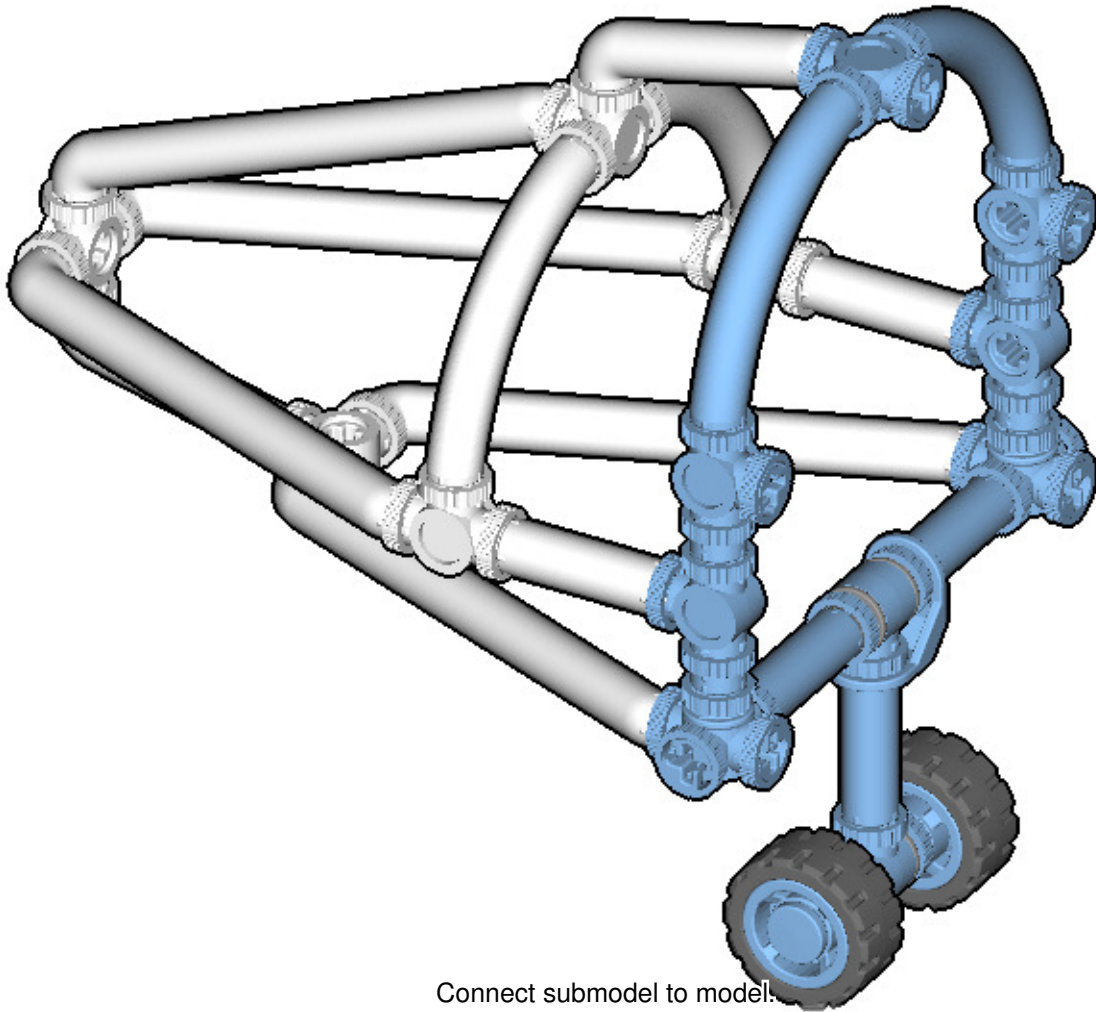

Connect submodel to model.

10

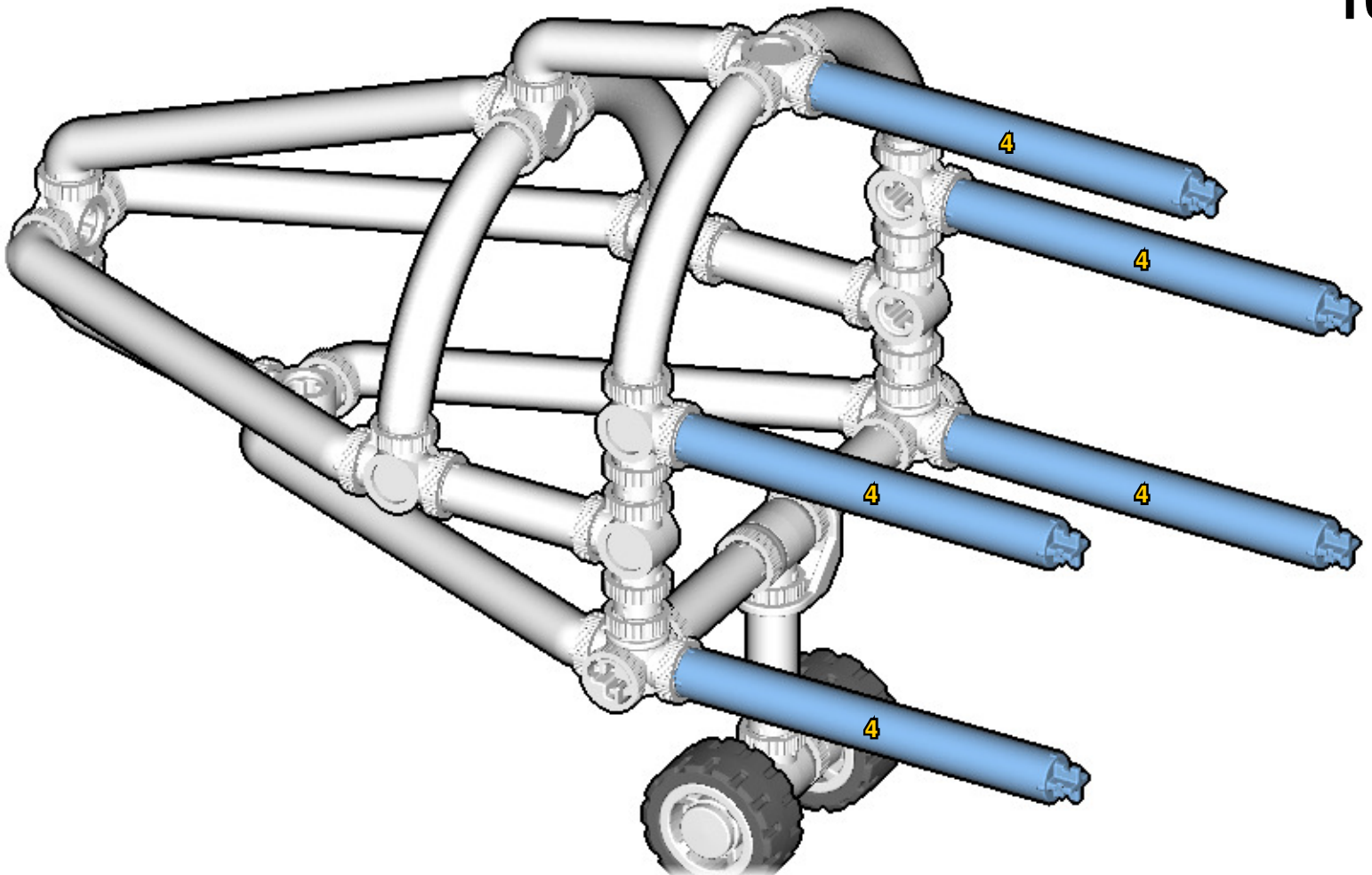

11

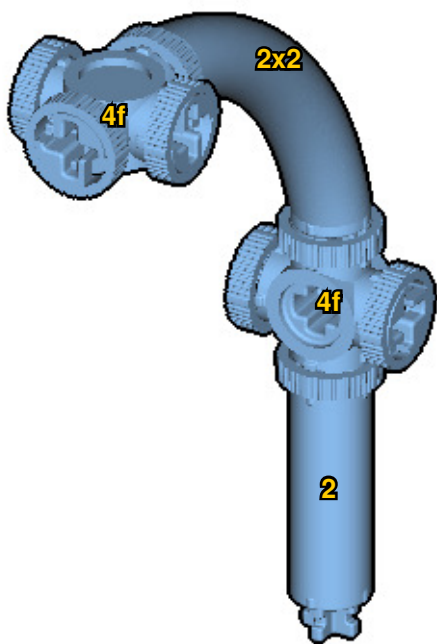

12

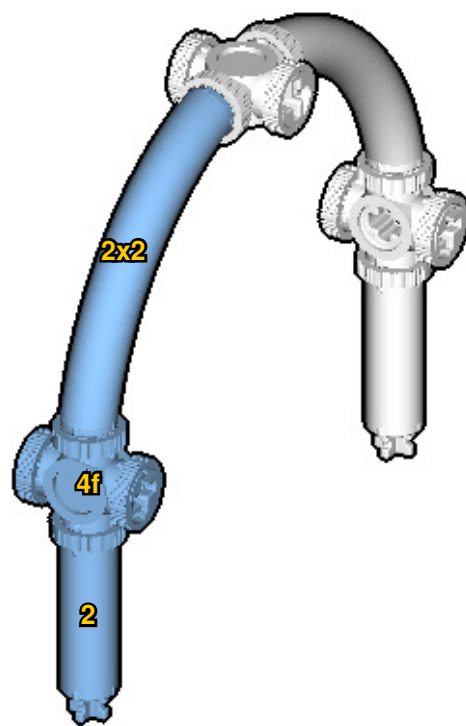

13

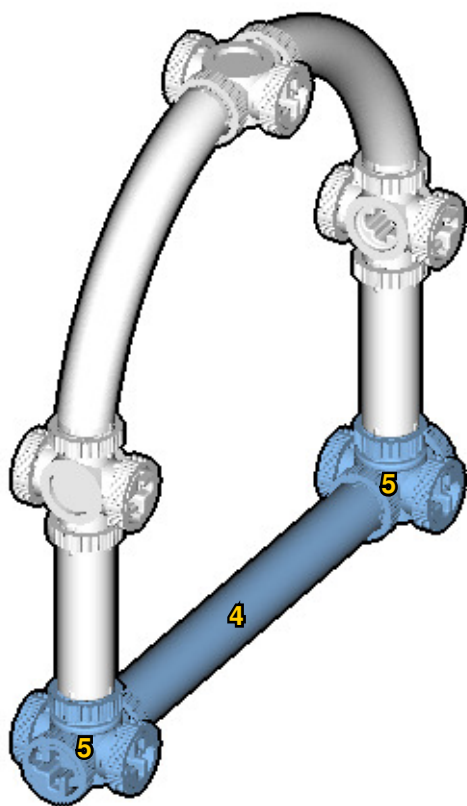

14

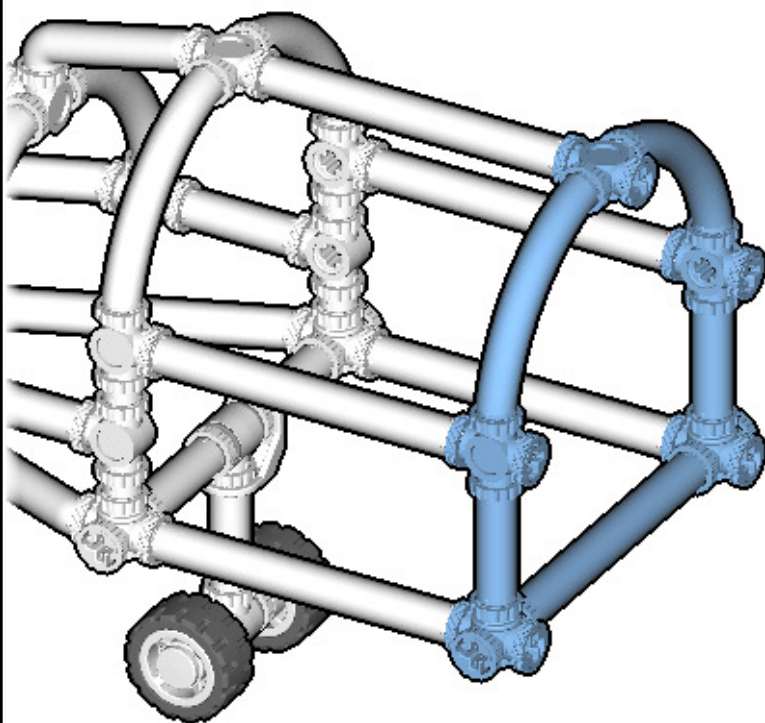

15

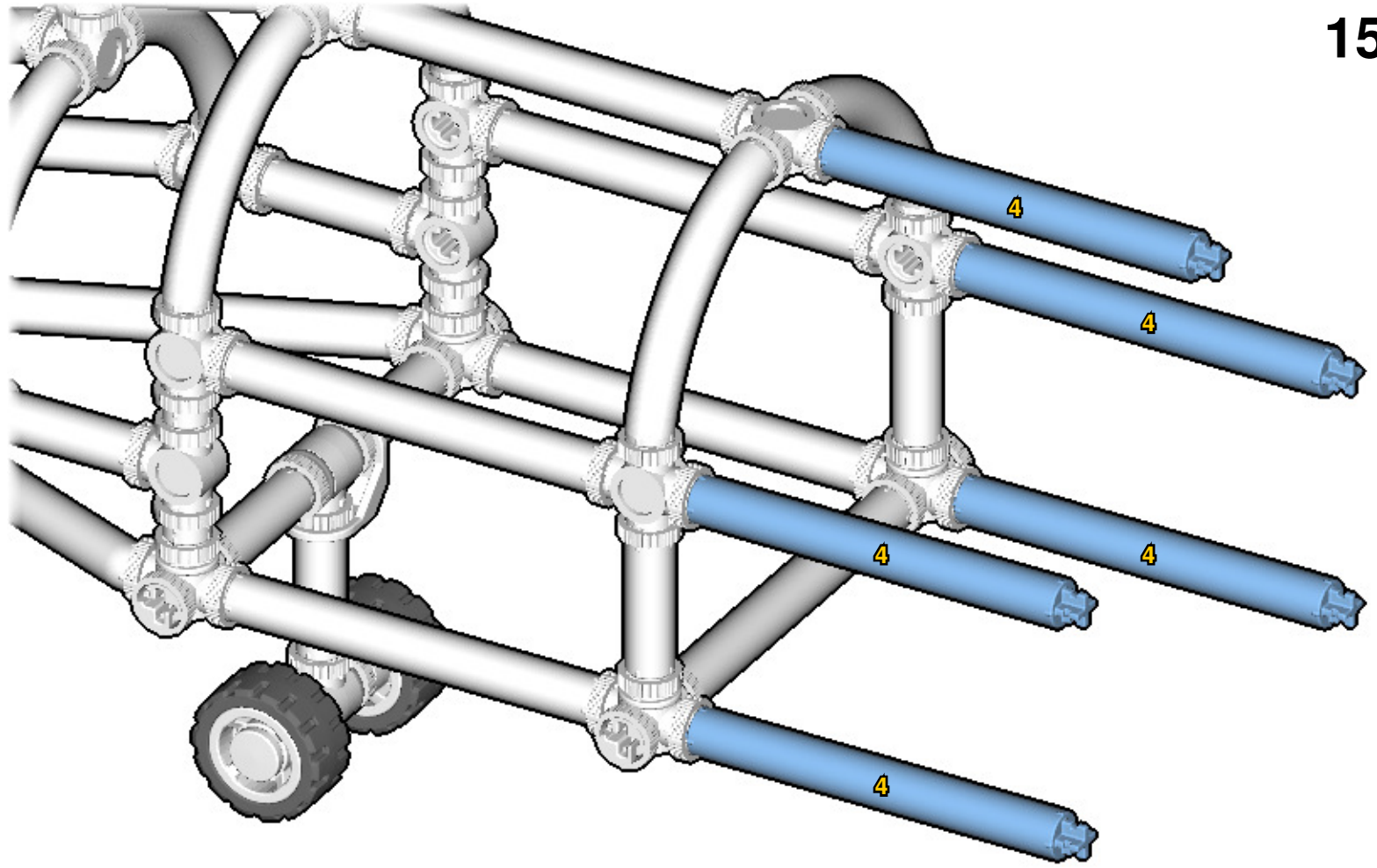

16

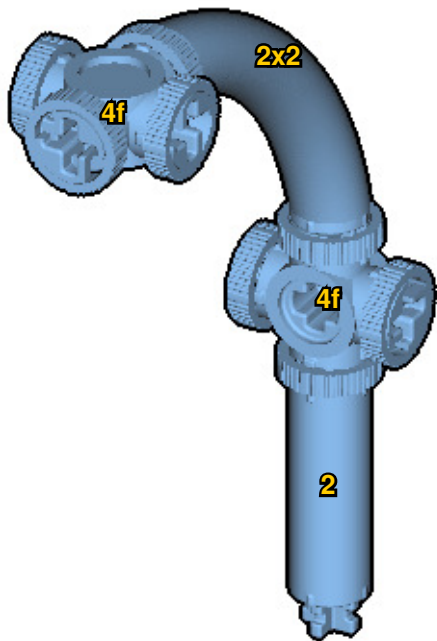

17

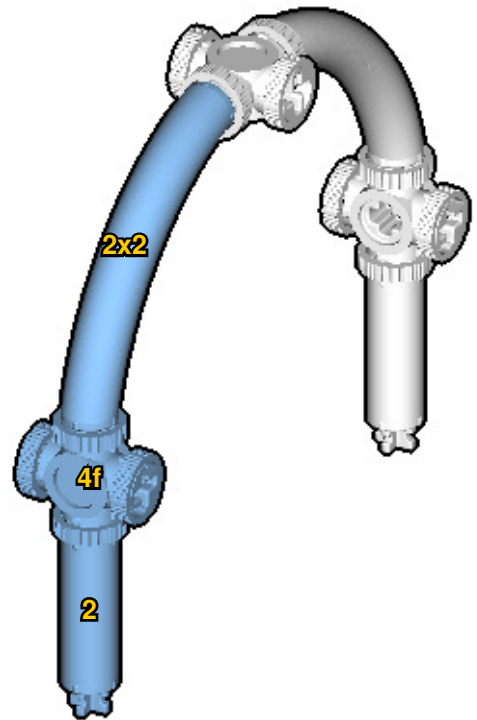

18

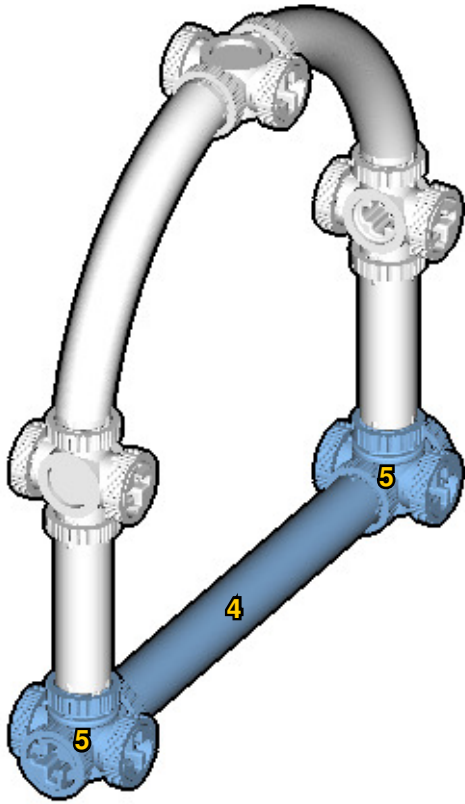

19

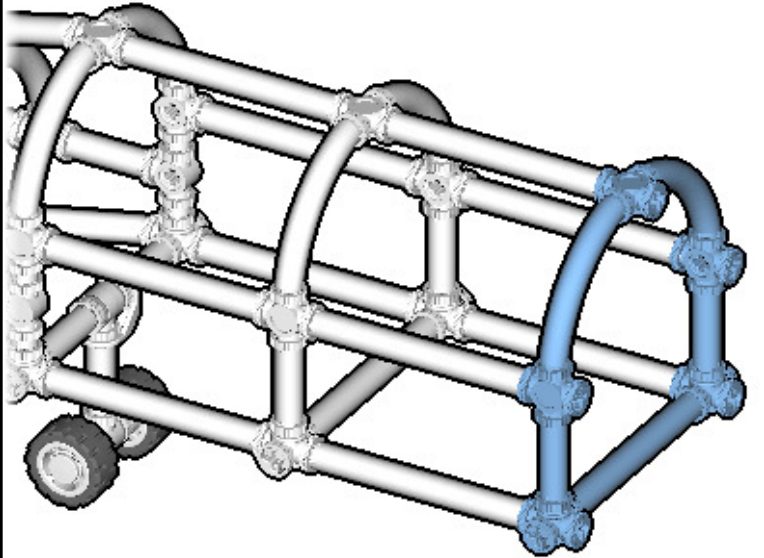

20

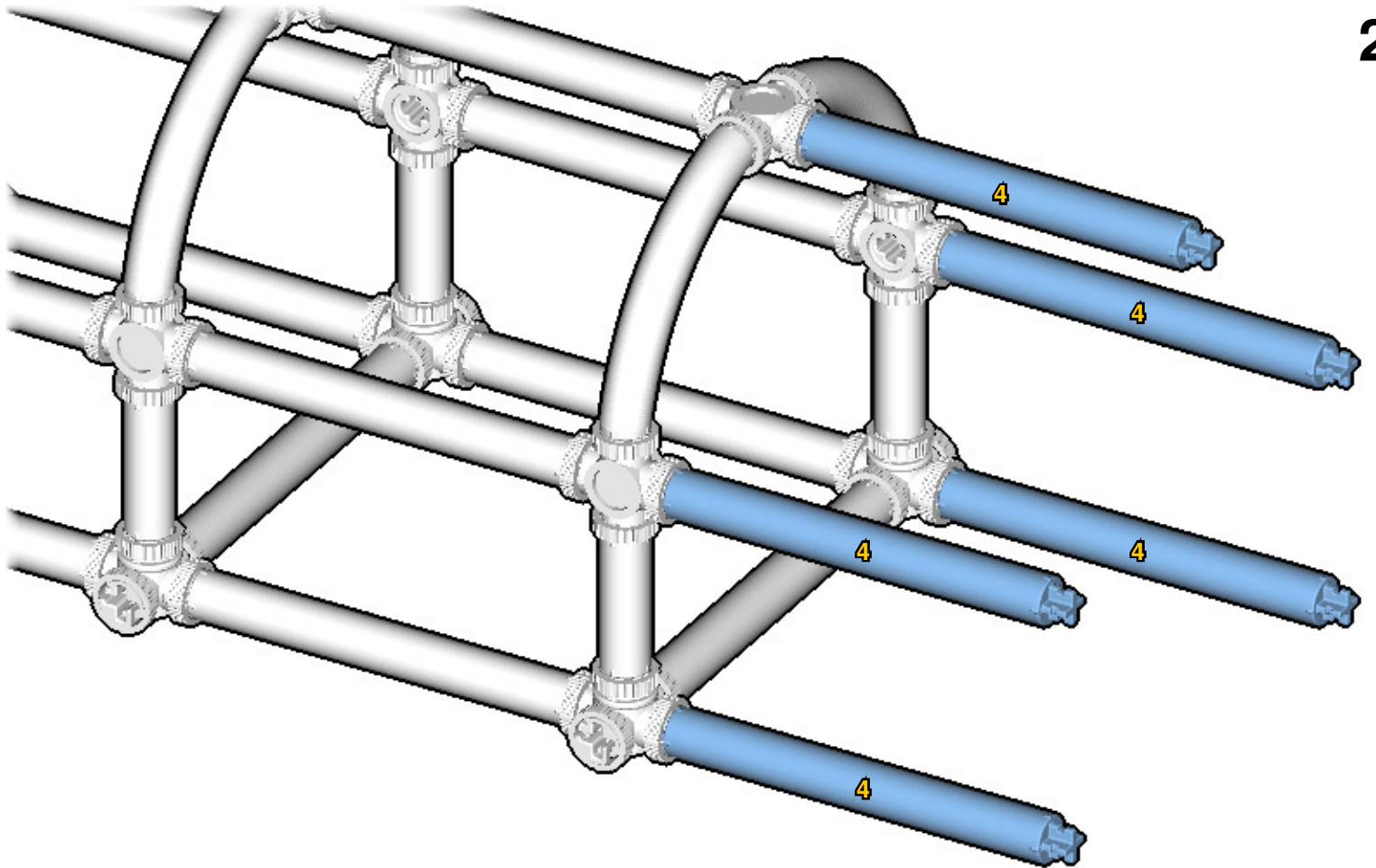

21

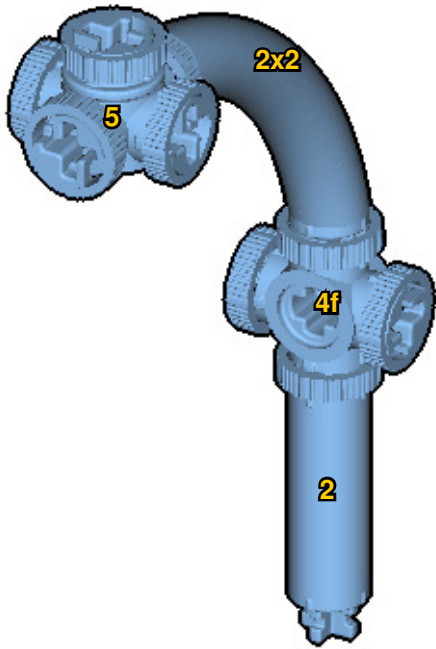

22

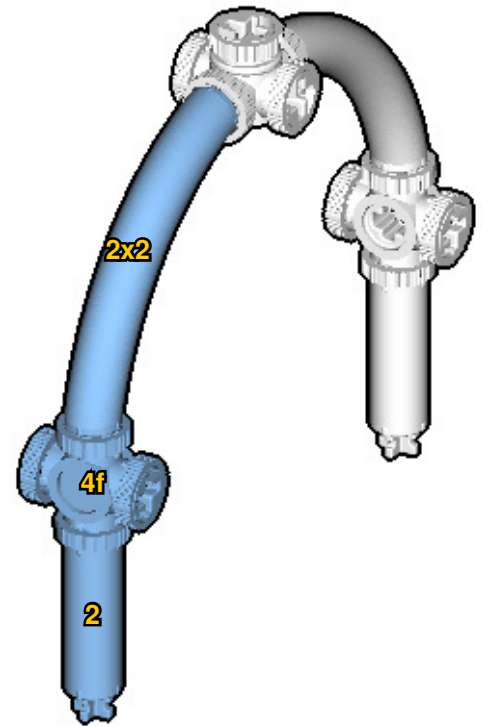

23

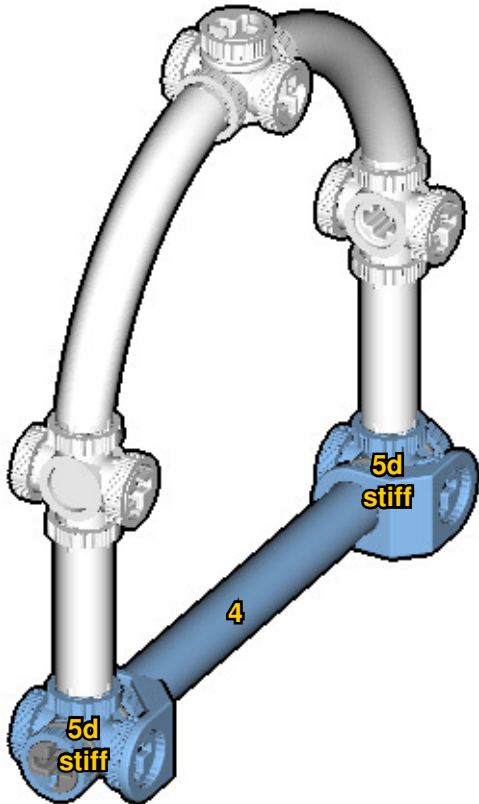

24

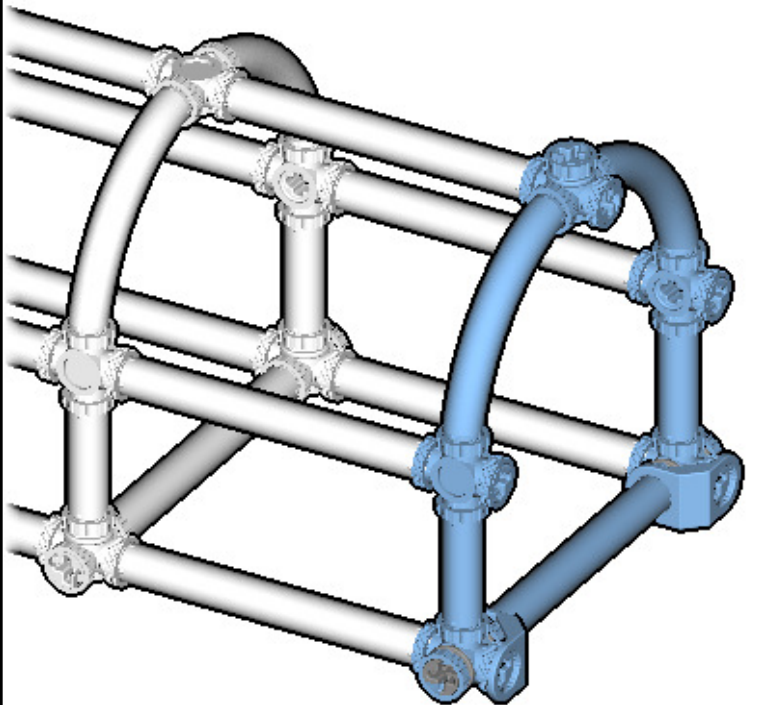

25

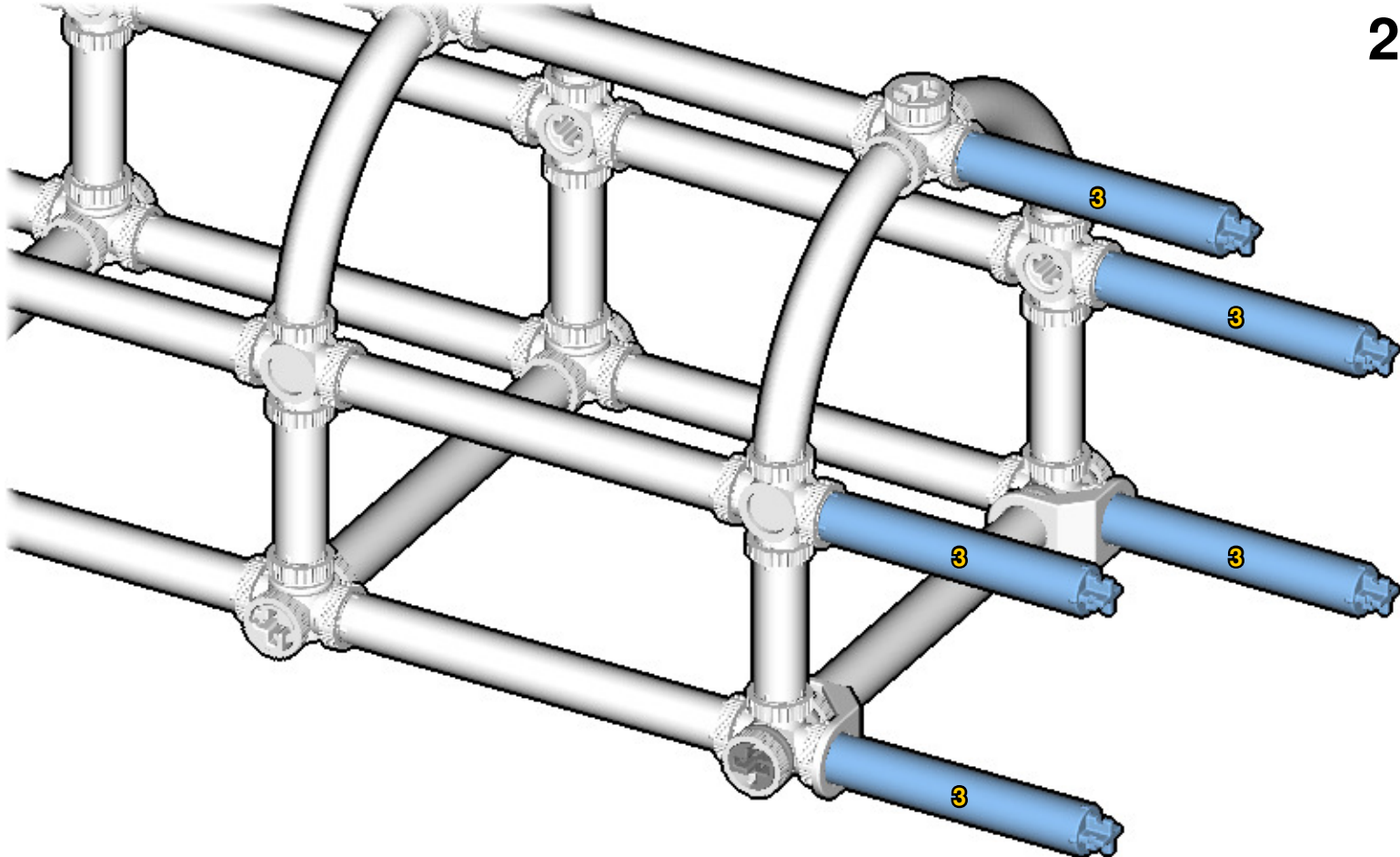

26



27

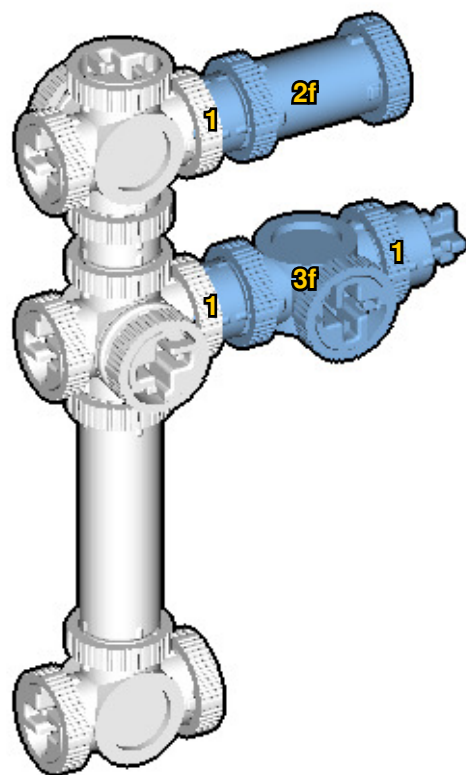

28

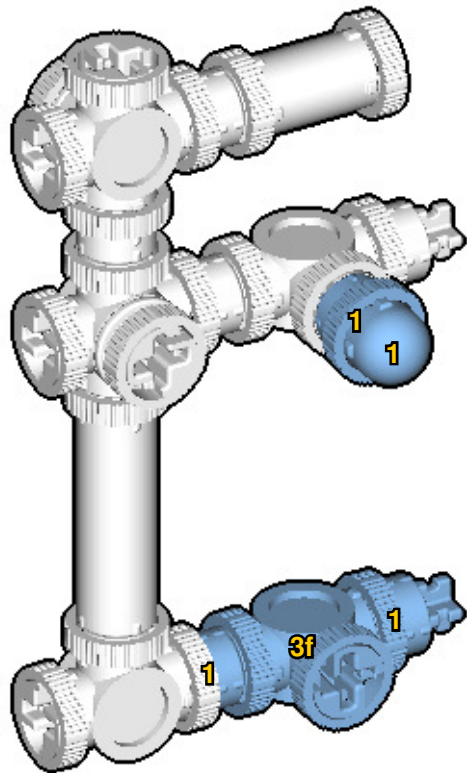

29

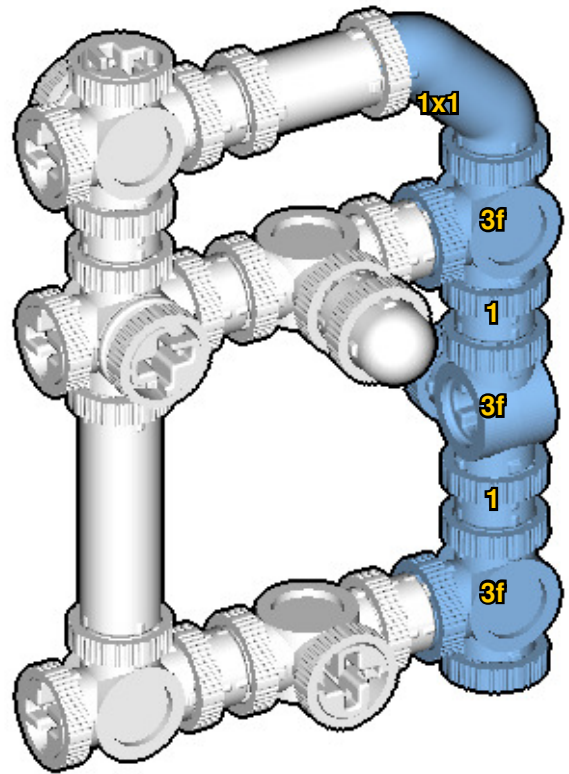

30

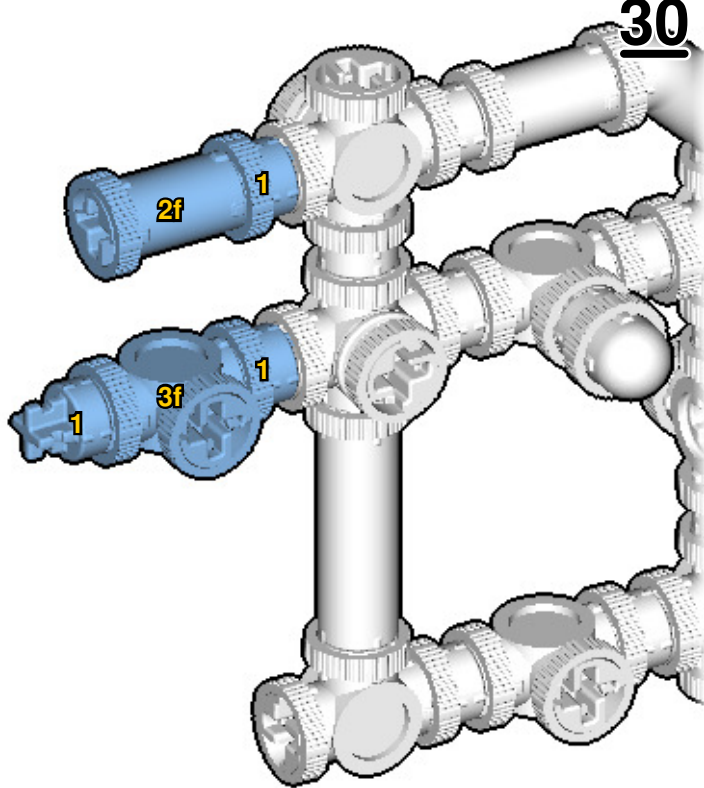

31

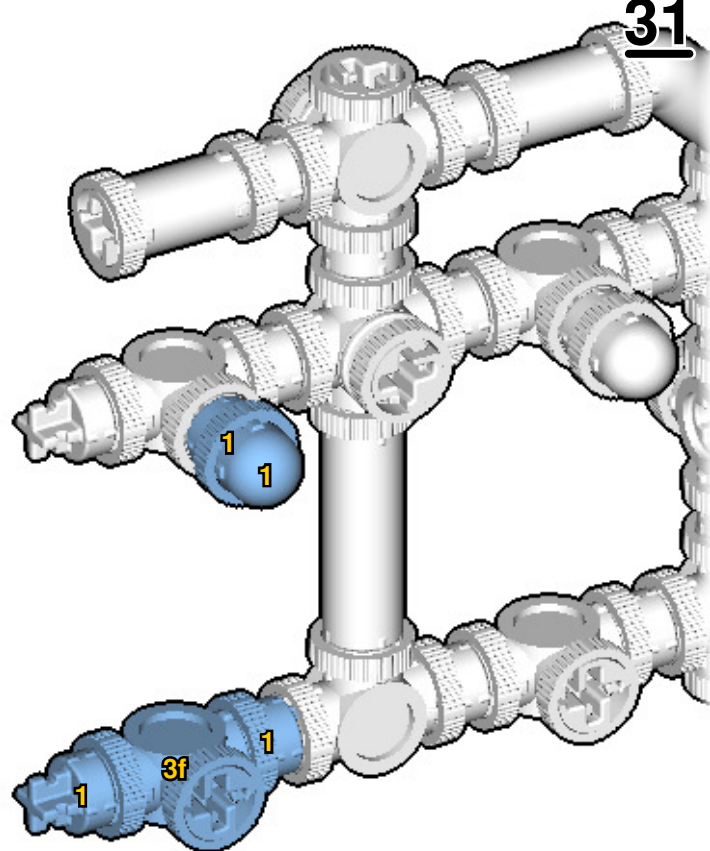

32

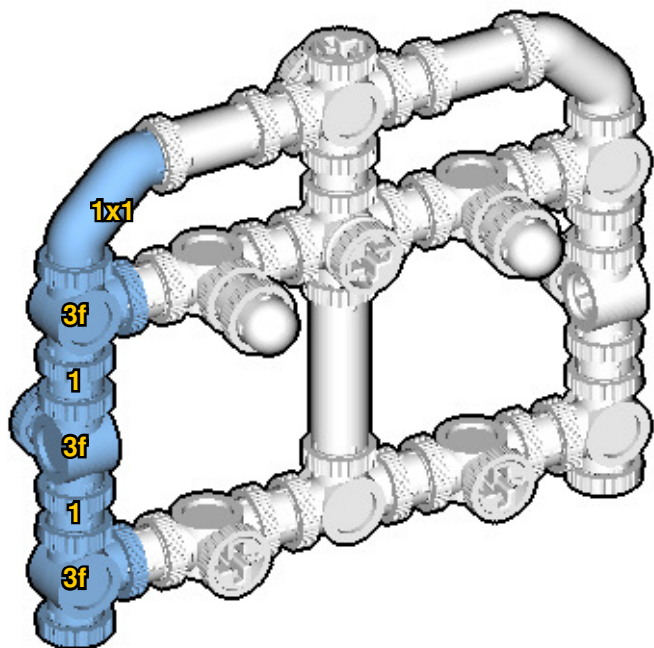

33

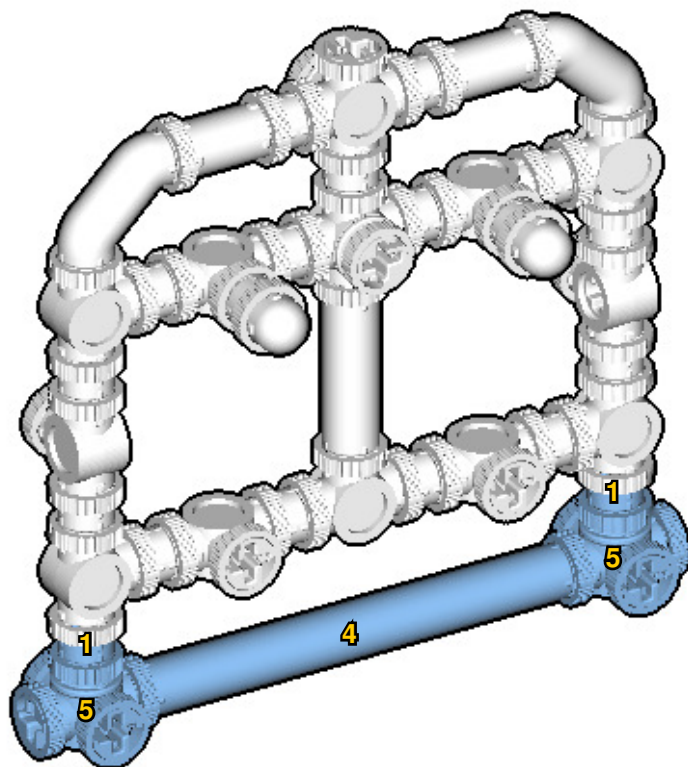

34

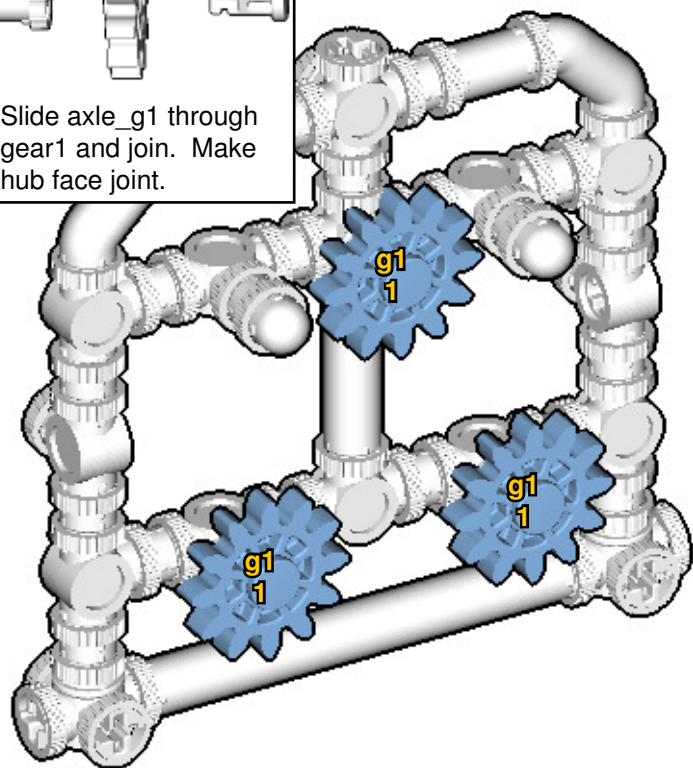
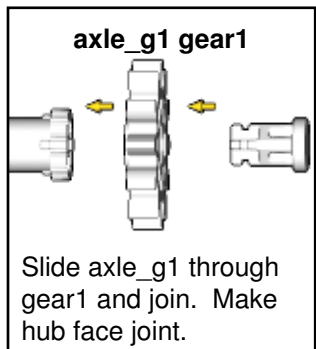

35

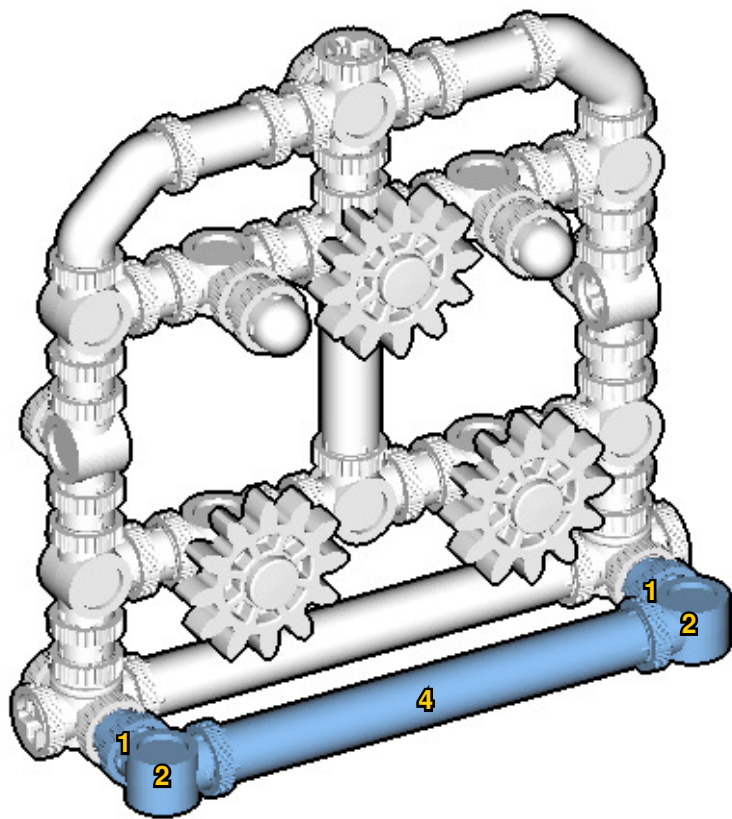

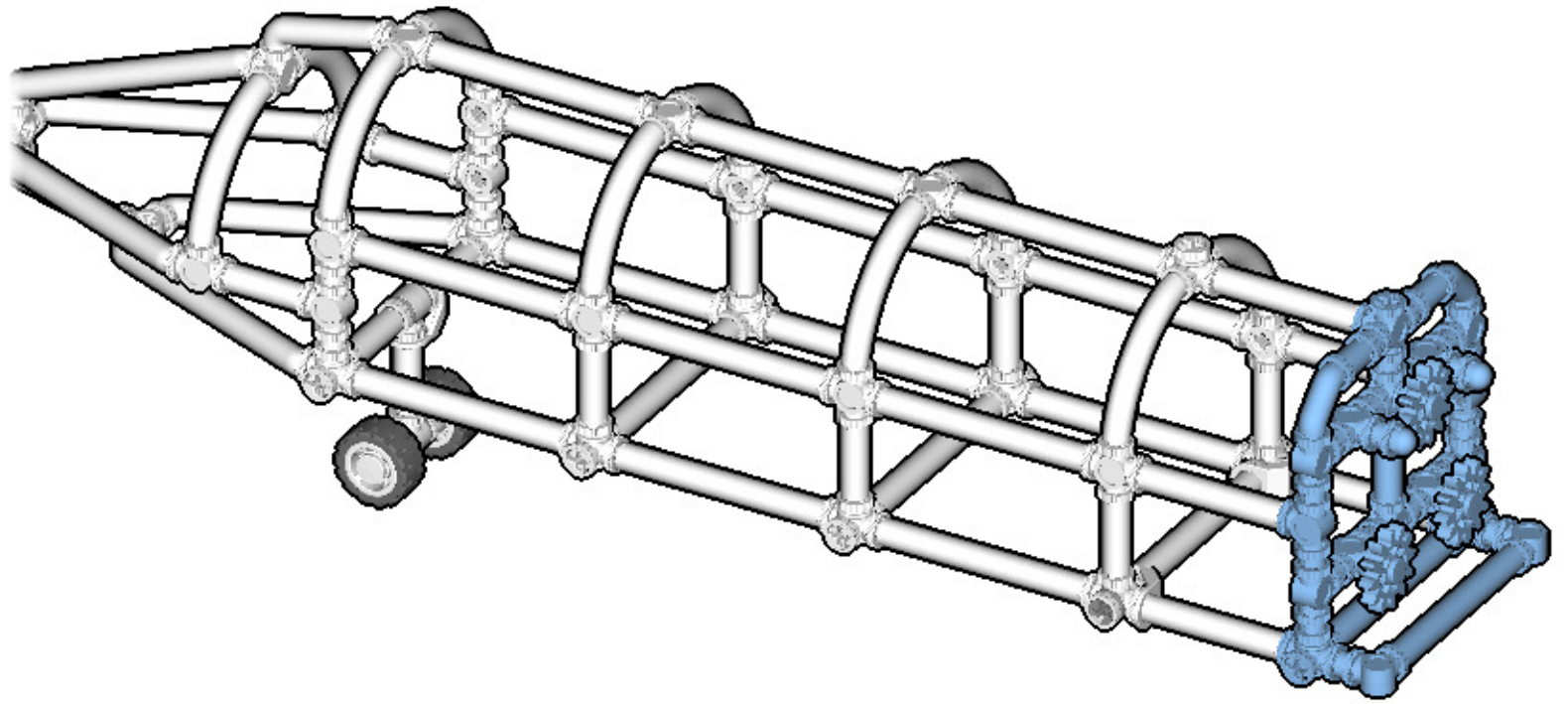

37

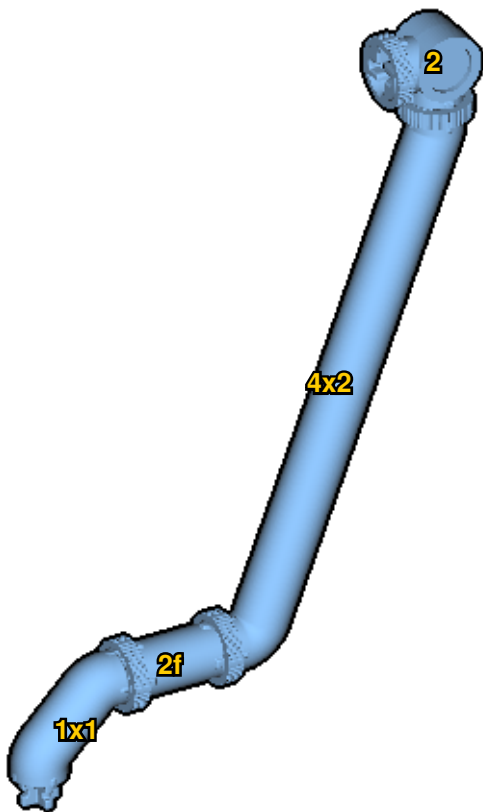

38

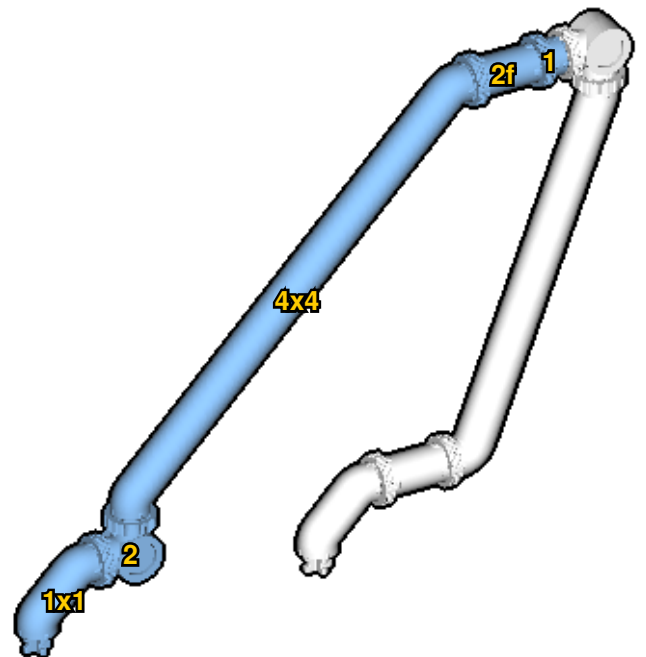

39

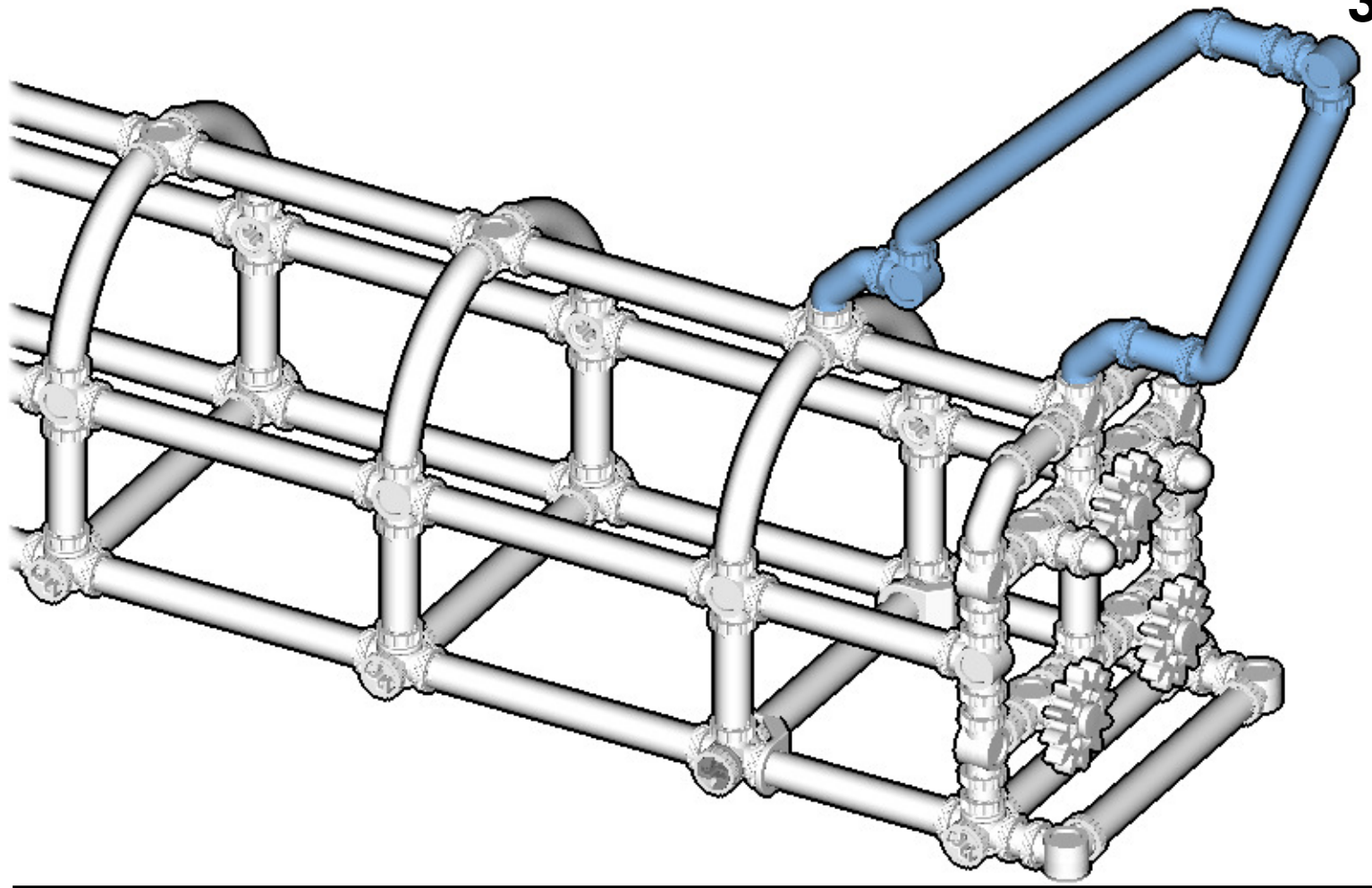

40

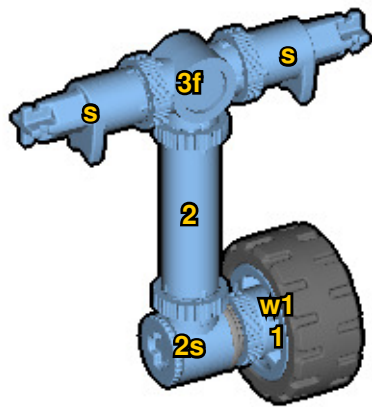

41

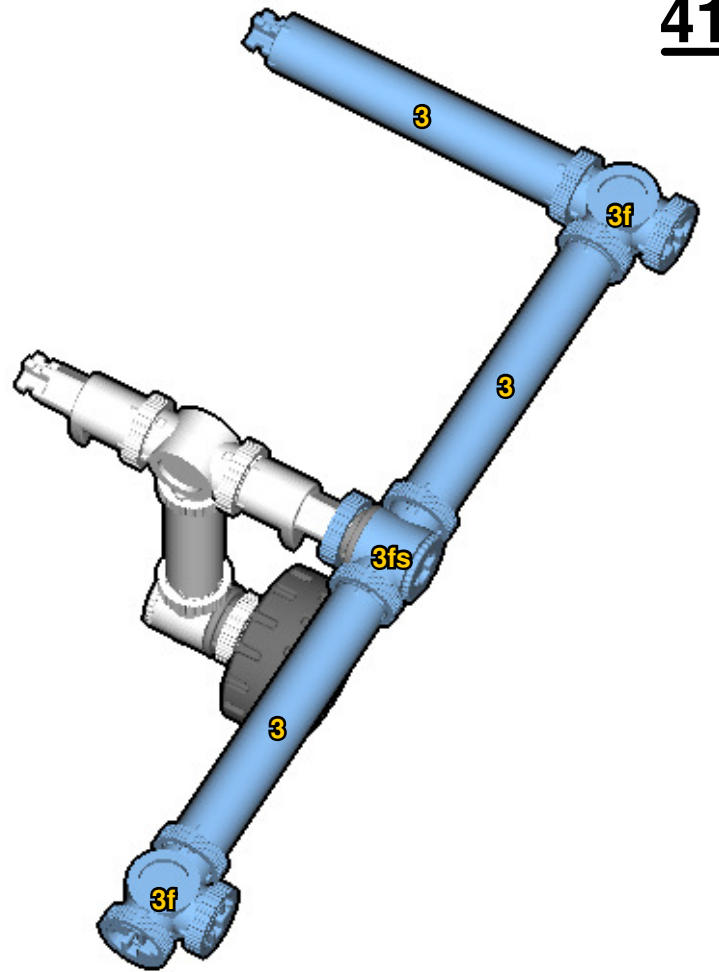

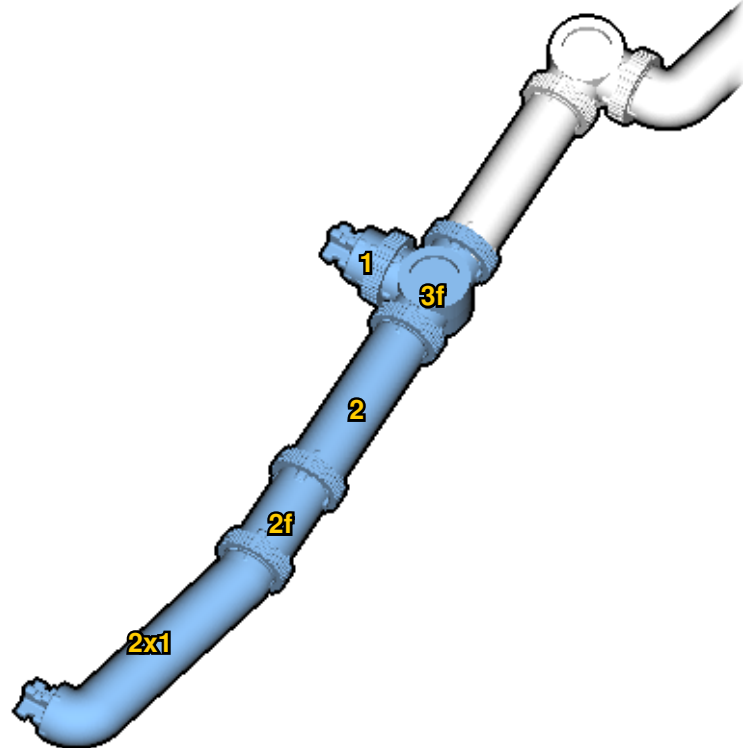
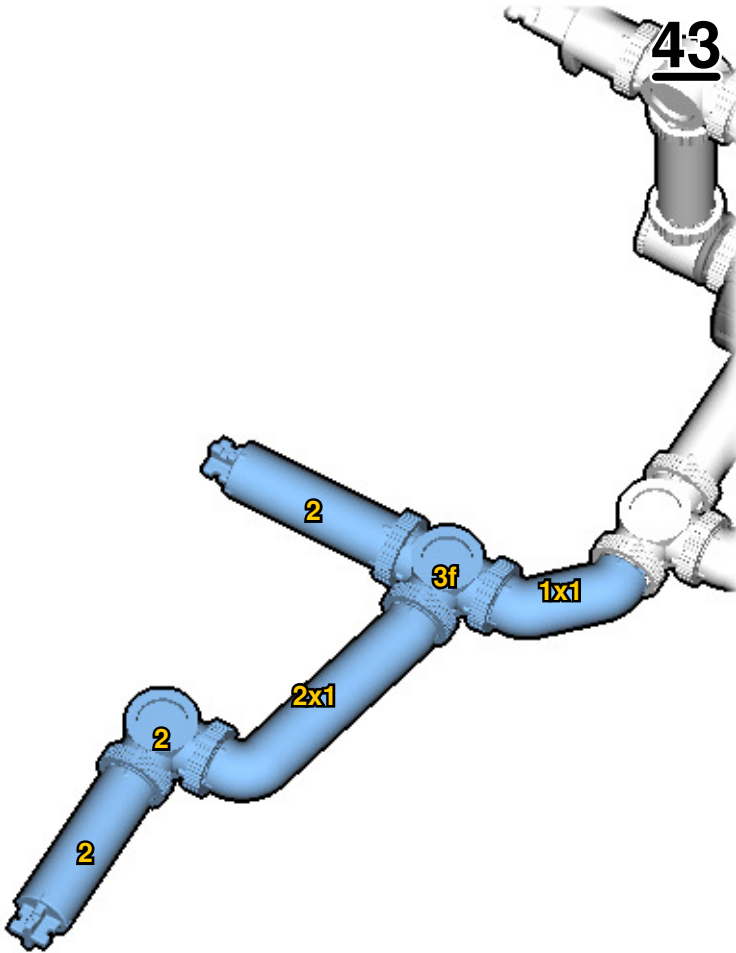
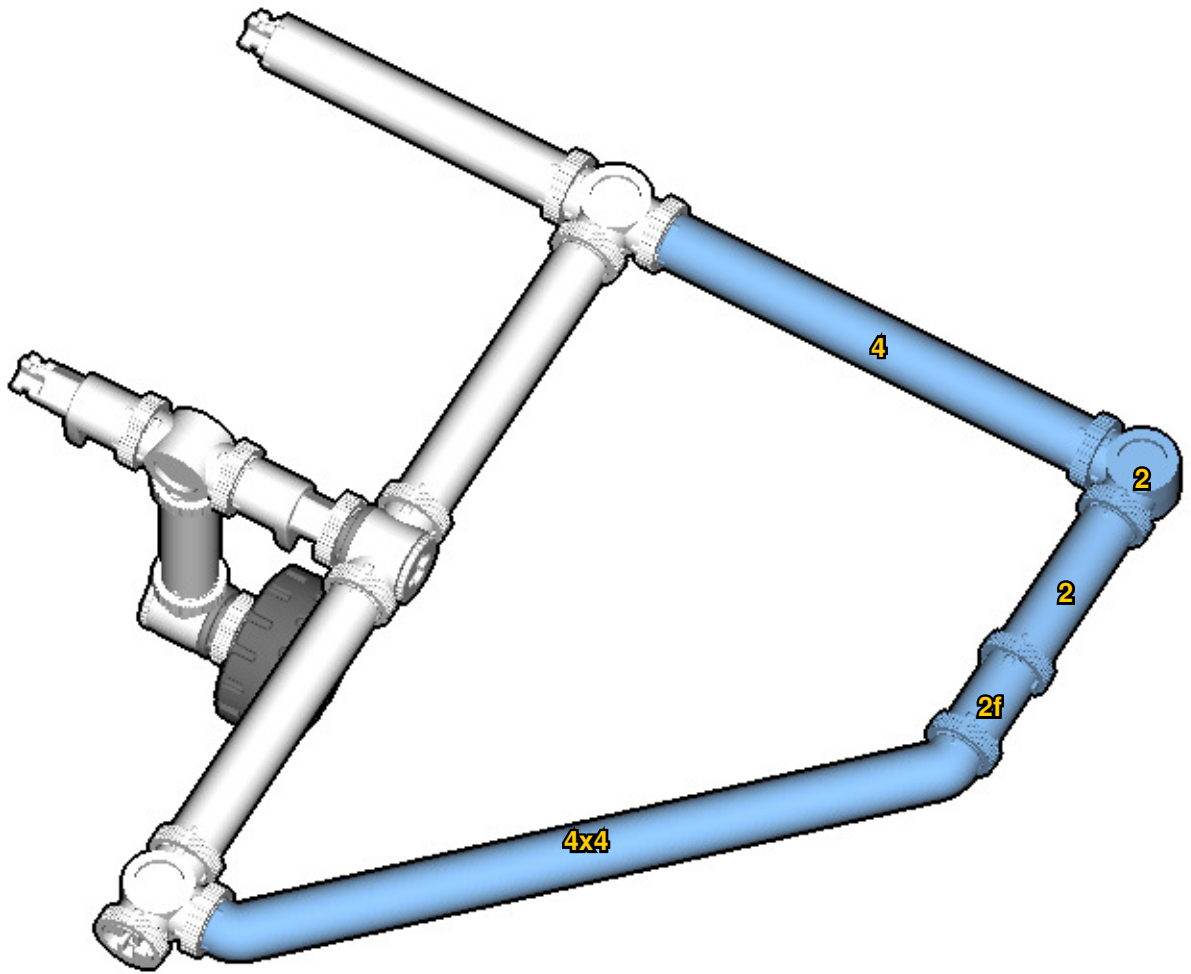

45

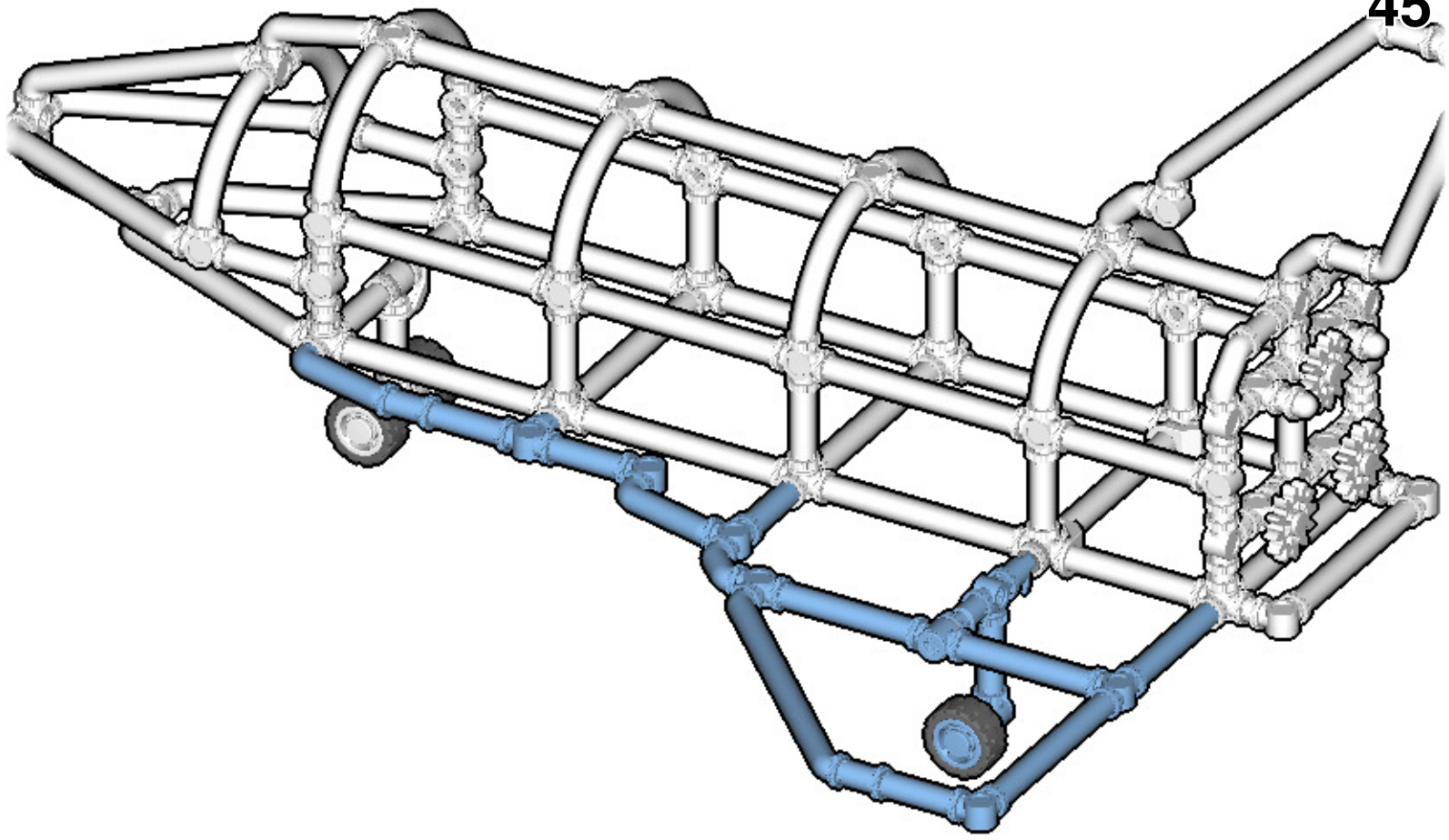

46

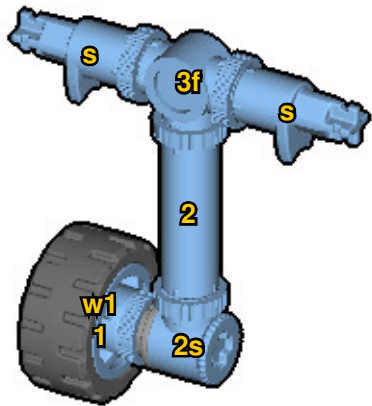

47

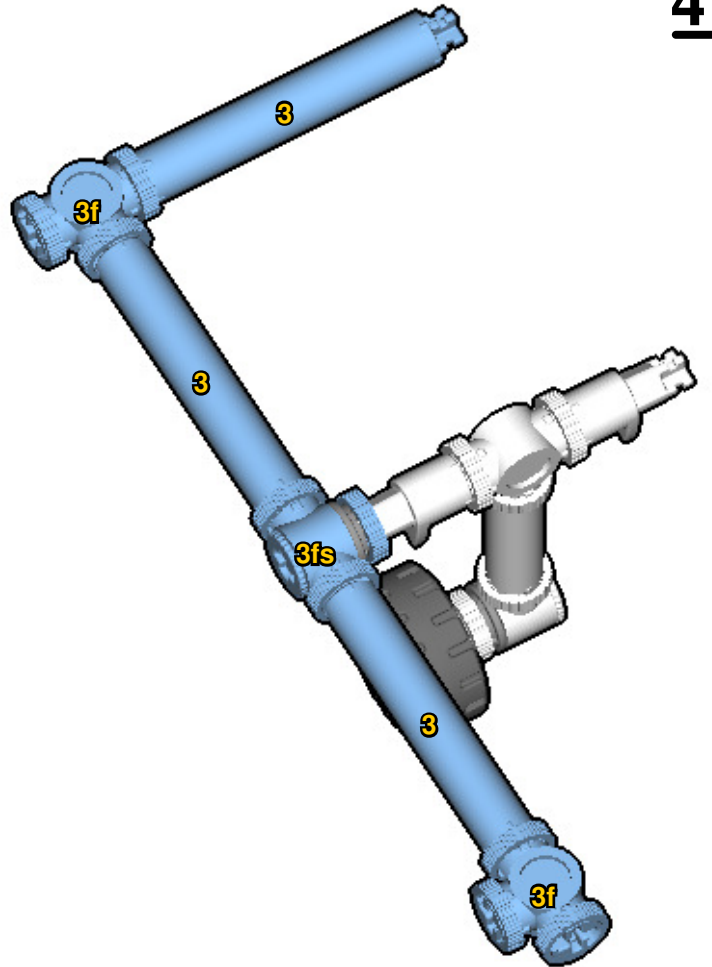

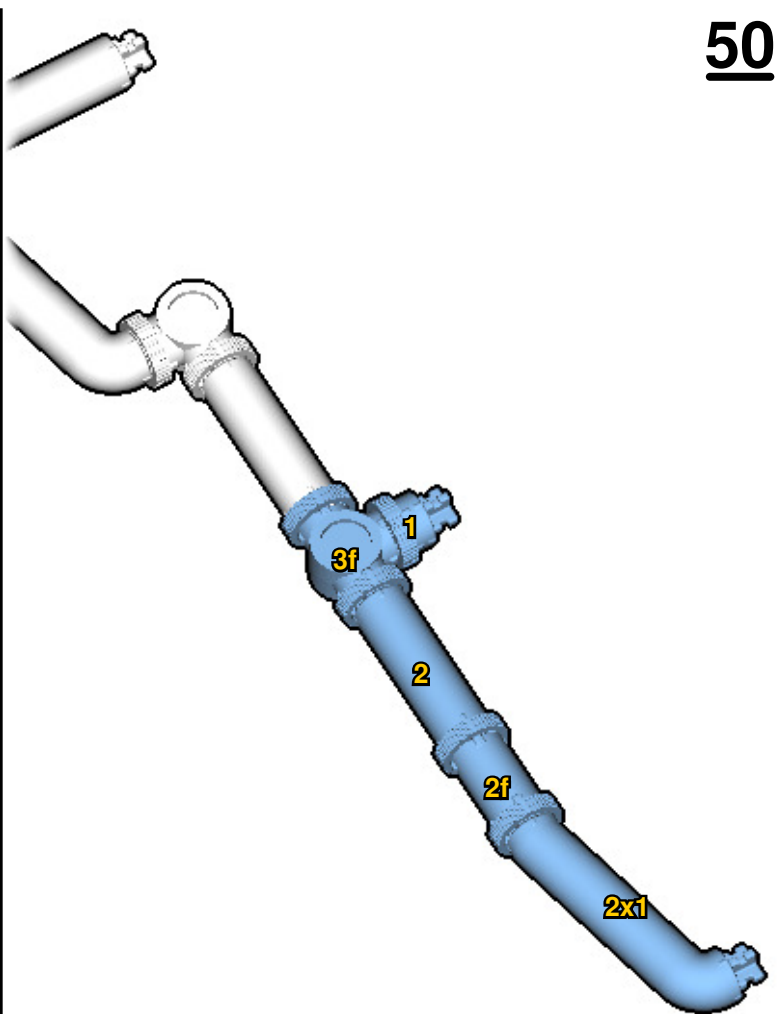
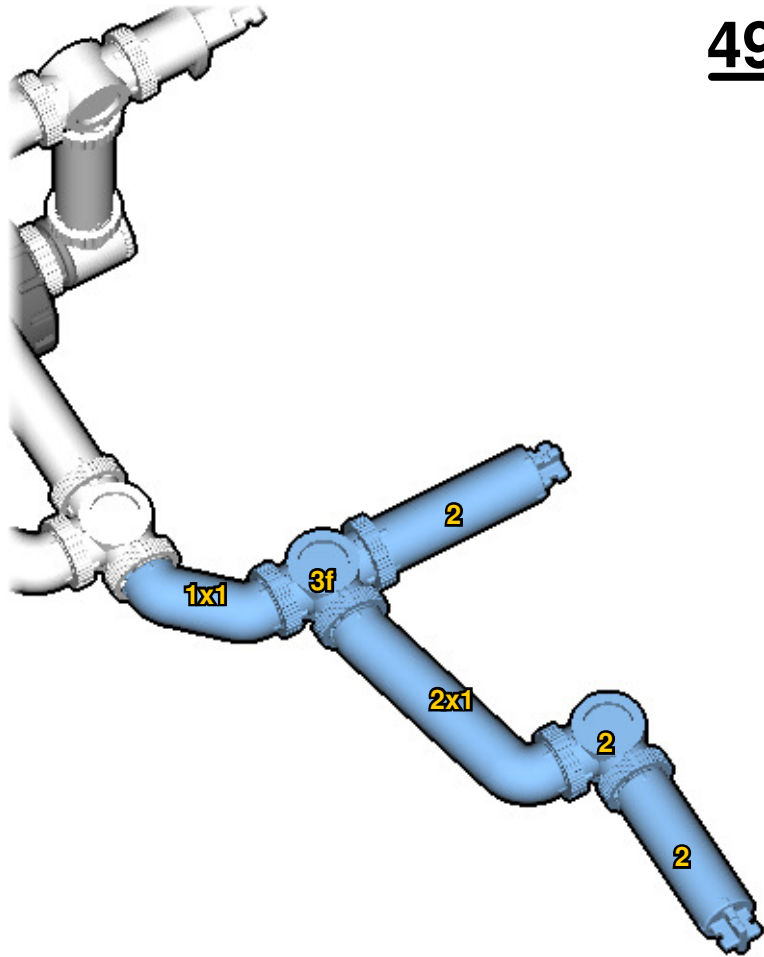
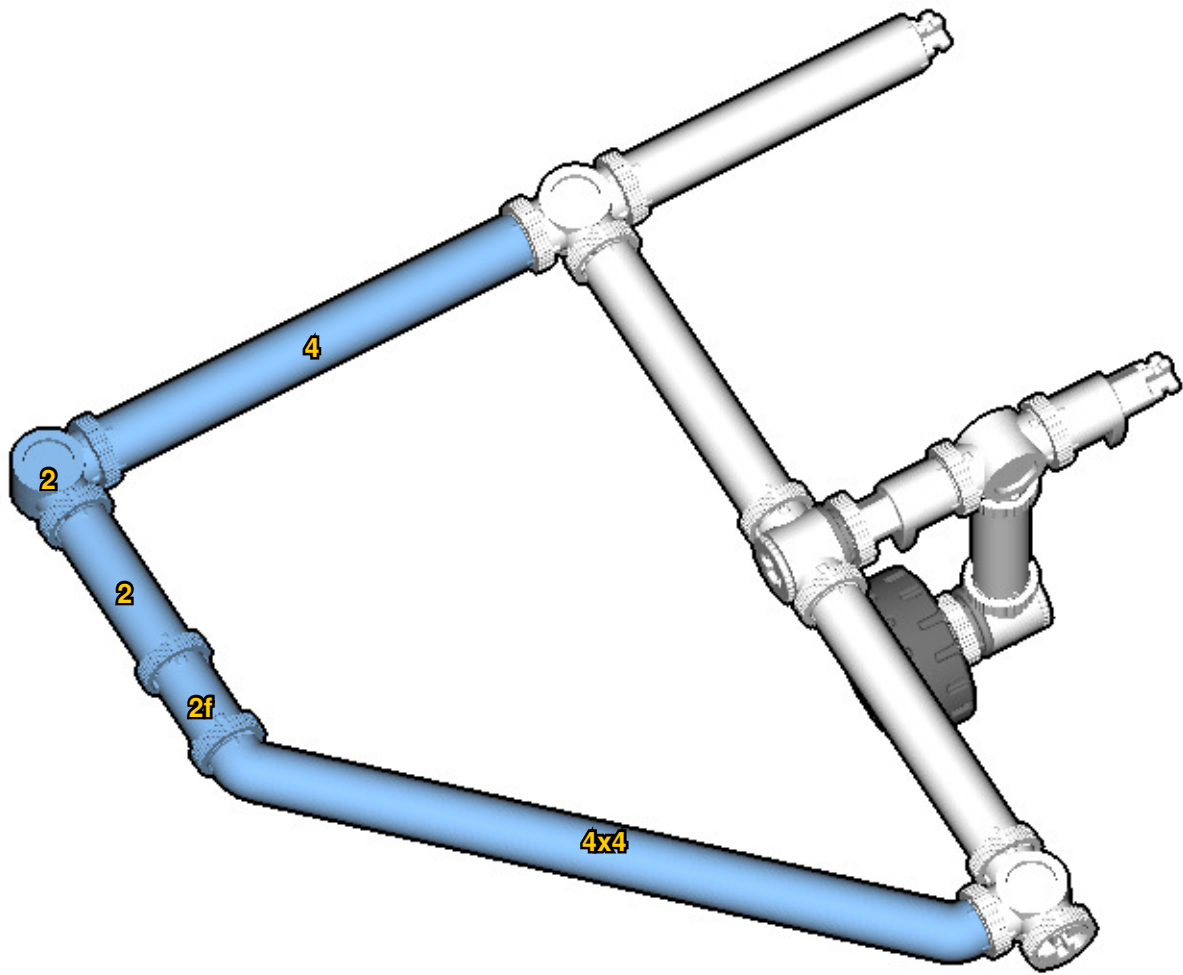

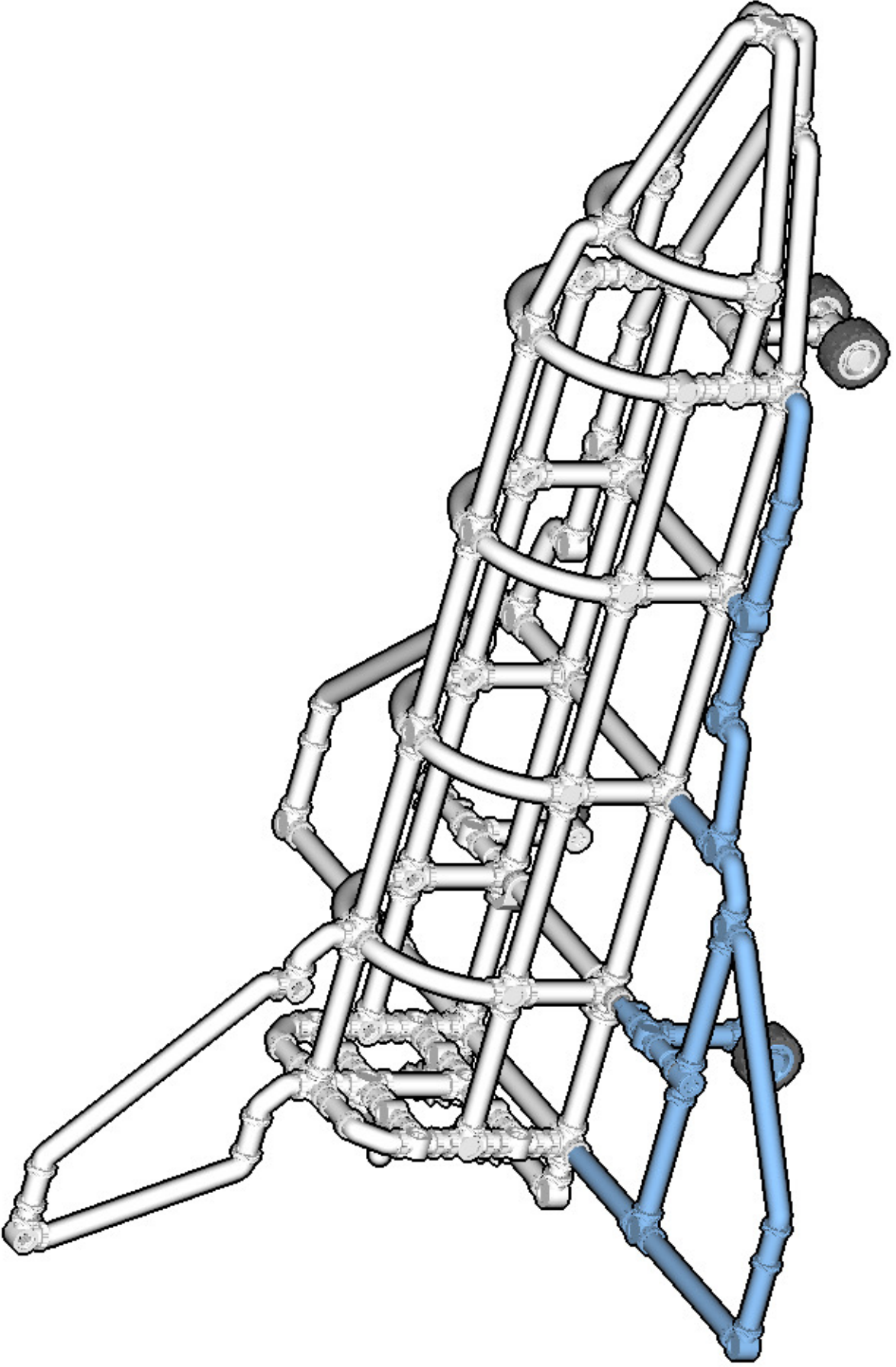

INVENTORY

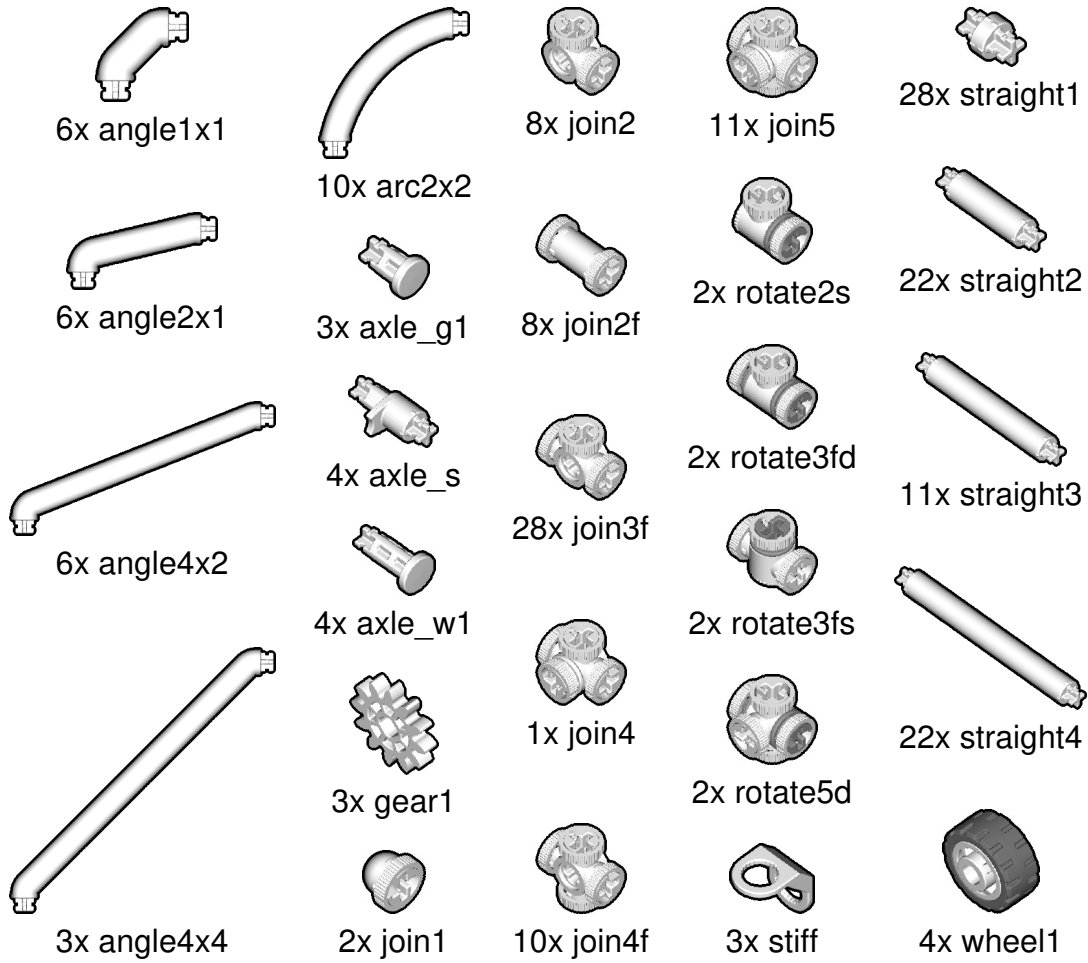

ACTUAL SIZE

