

SIZE	2.3ft x 0.4ft x 0.4ft	PIECES	186
DESIGNER	Derek Sharman	MADE IN	U.S.A.

# SUBMARINE

⚠ WARNING: Small parts. Age 12+. Handle responsibly. U.S. Patent 9,086,087.

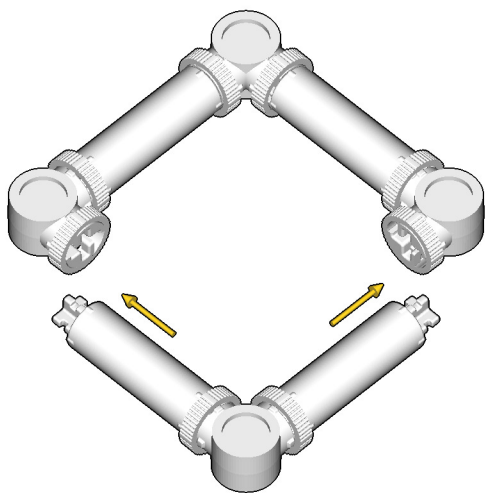
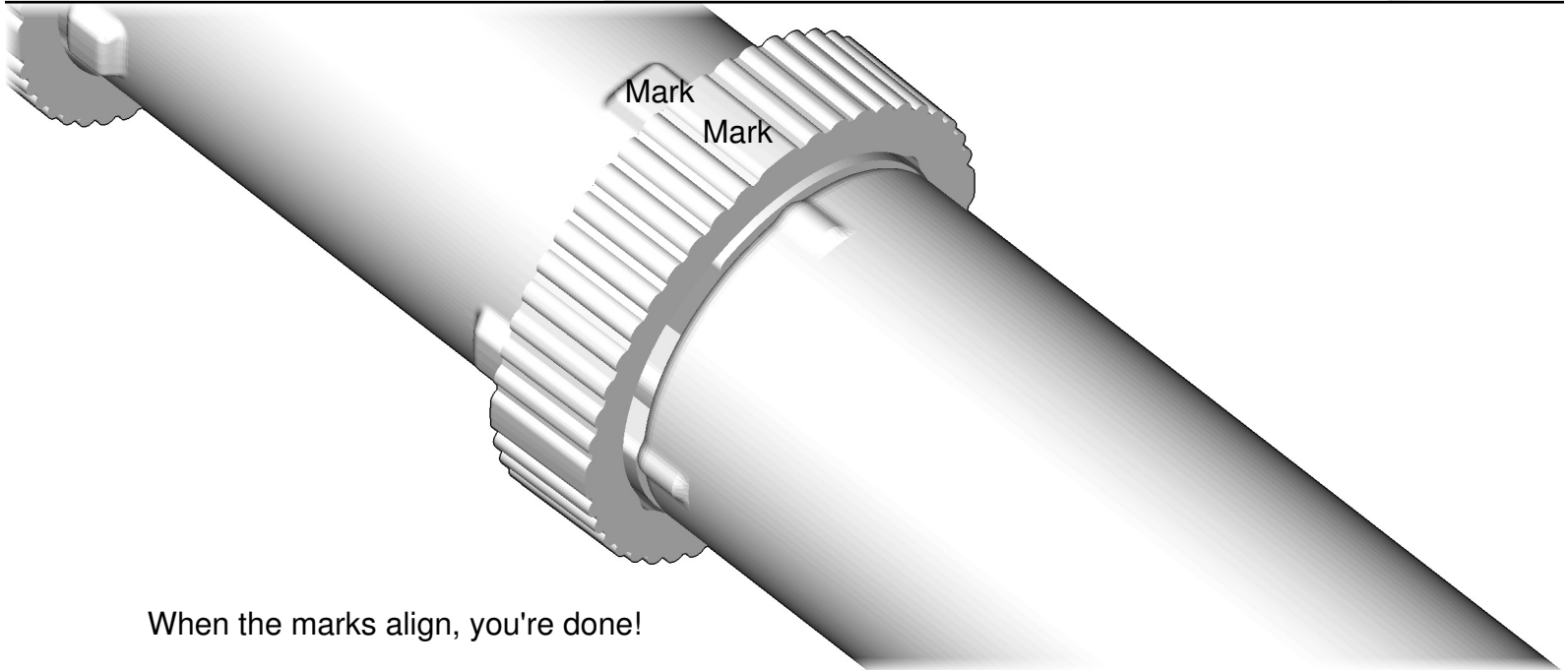
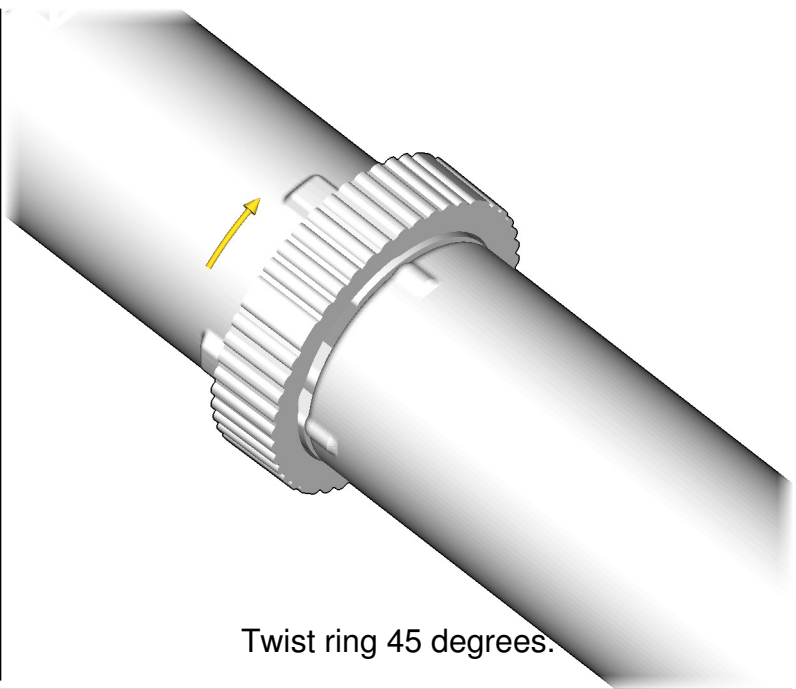
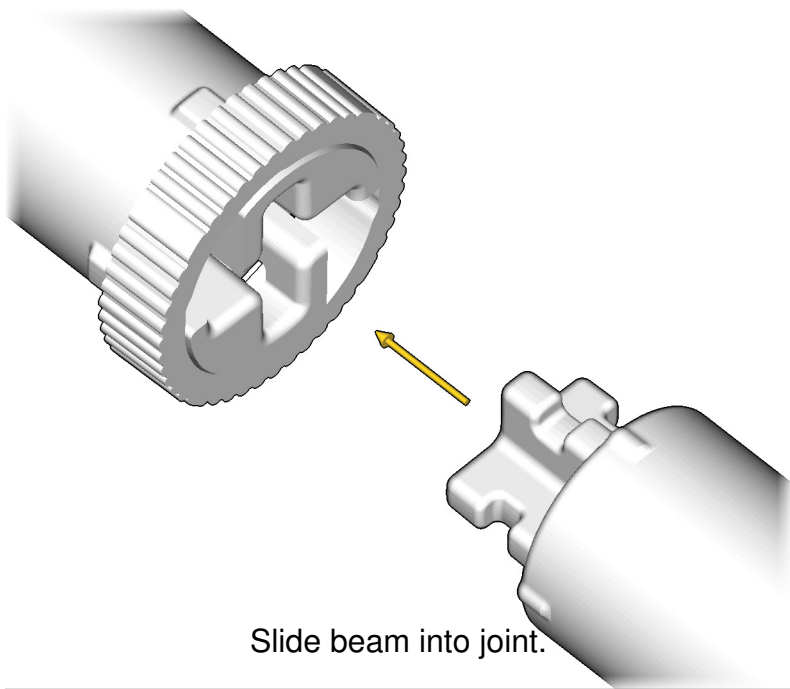

Wrong  
Connecting/Disconnecting Two Directions

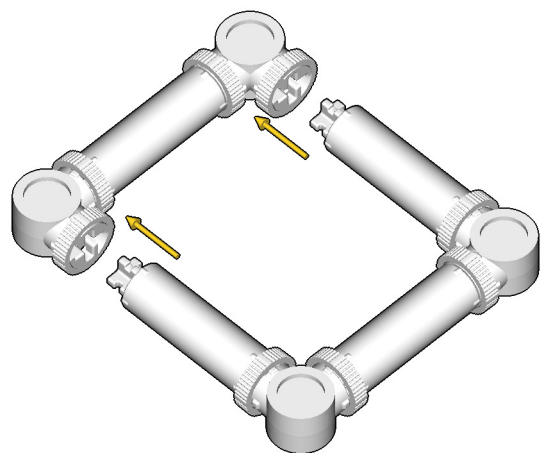

Right  
Connecting/Disconnecting One Direction

1

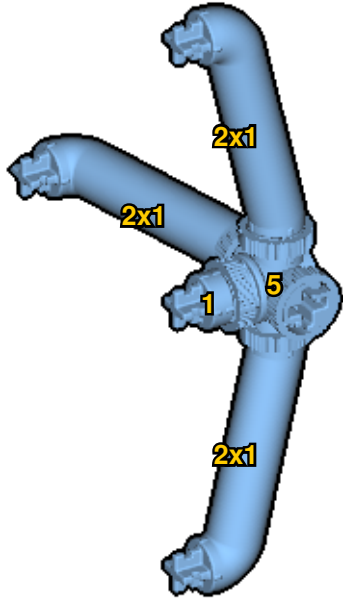

New pieces are drawn blue. Old pieces are drawn white.  
See back for piece names.

2

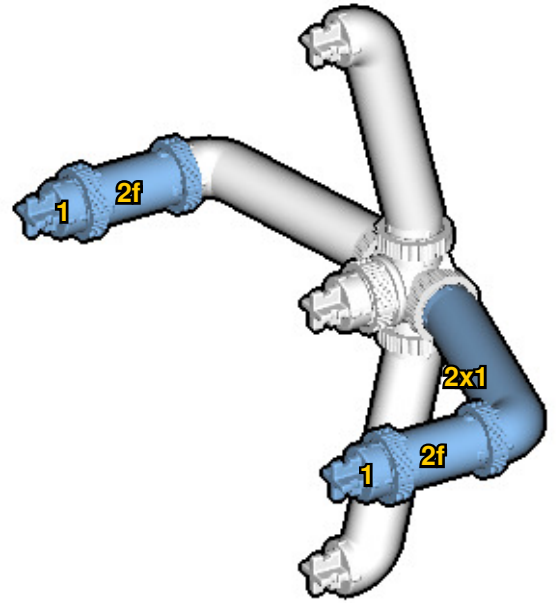

Connect new pieces together before connecting to old pieces.

3

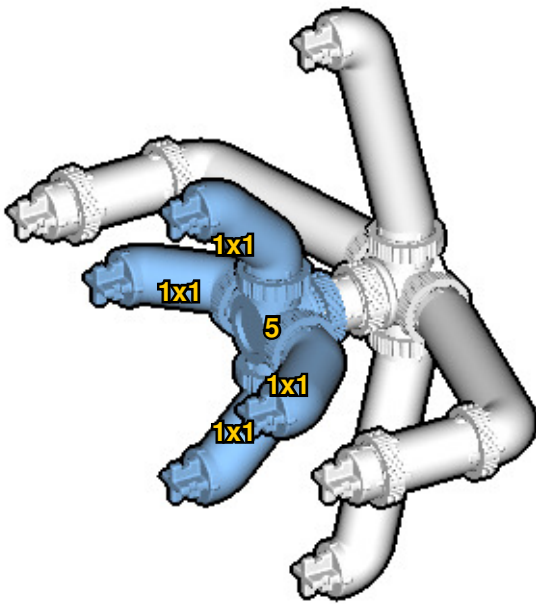

4

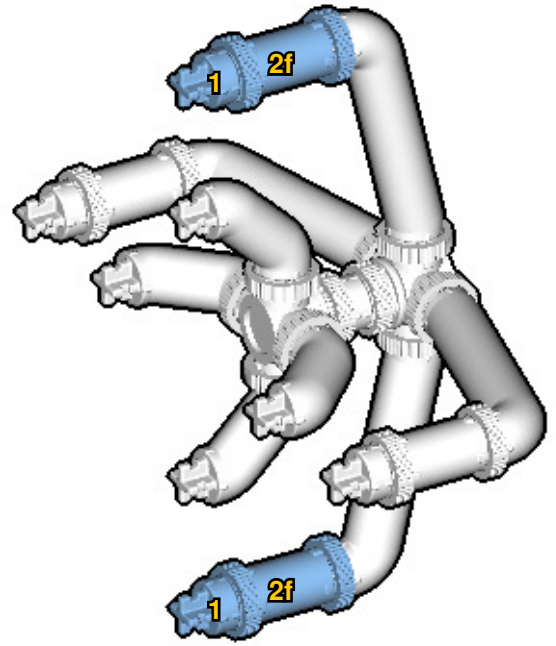

Submodel begins → **5**

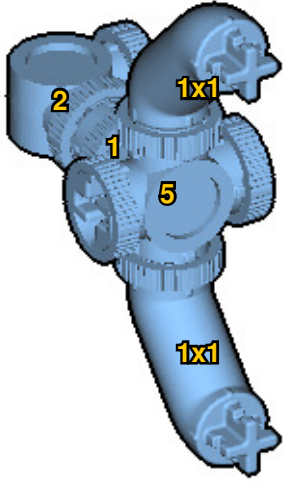

**6**

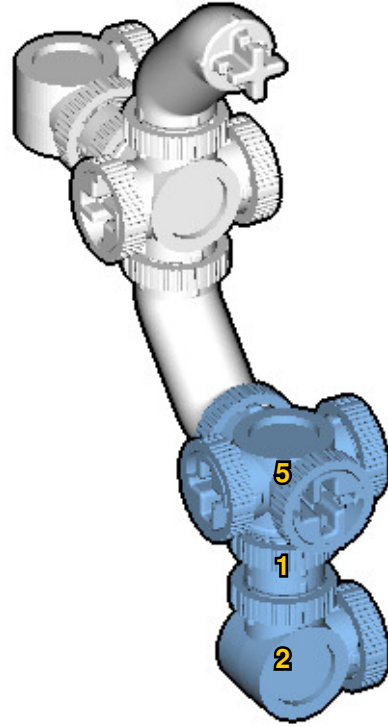

**7**

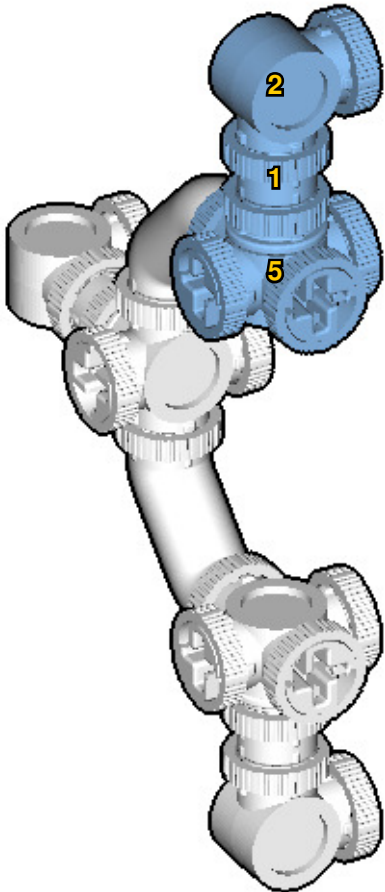

**8**

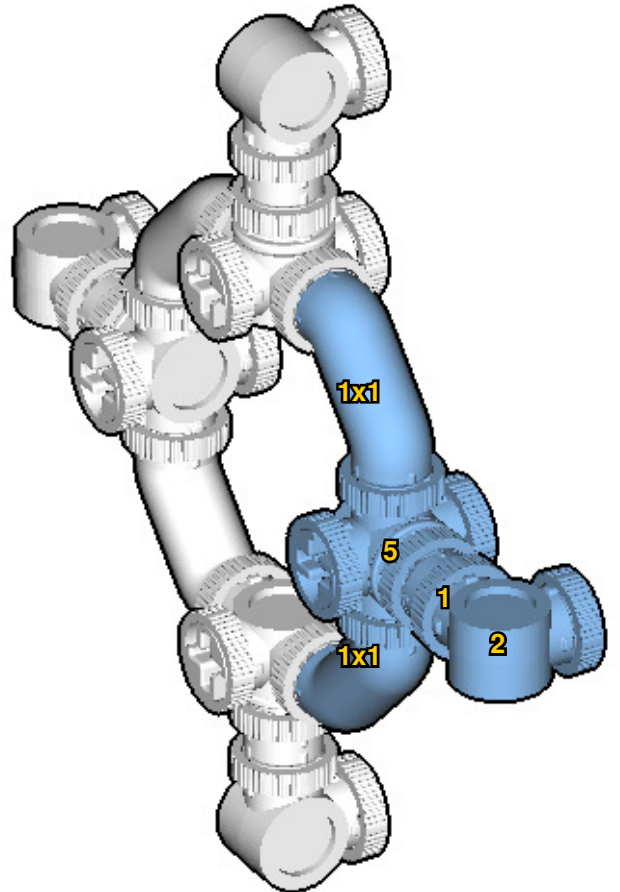



Submodel ends → **9**

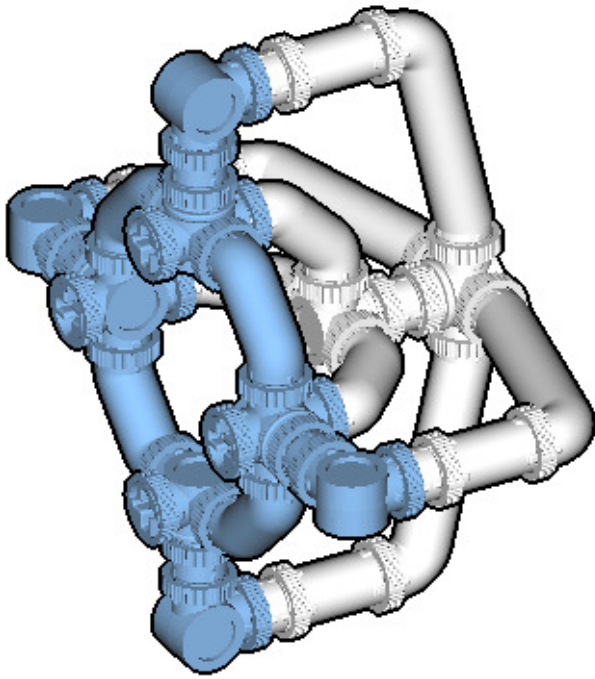

Connect submodel to model.

**10**

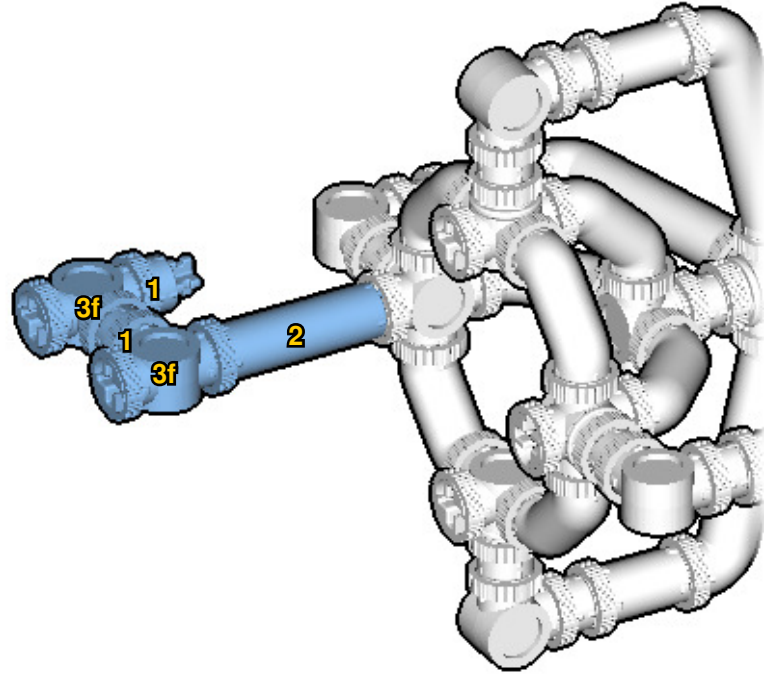

**11**

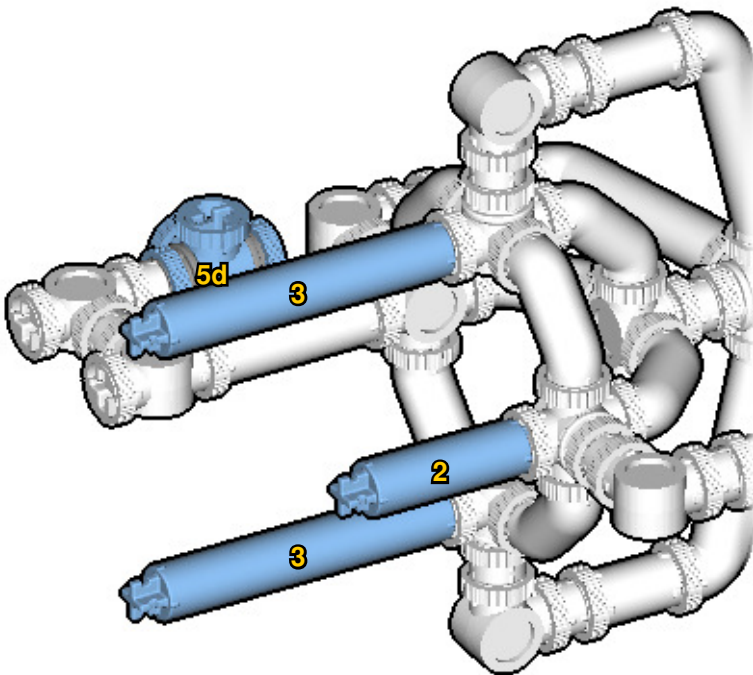

**12**

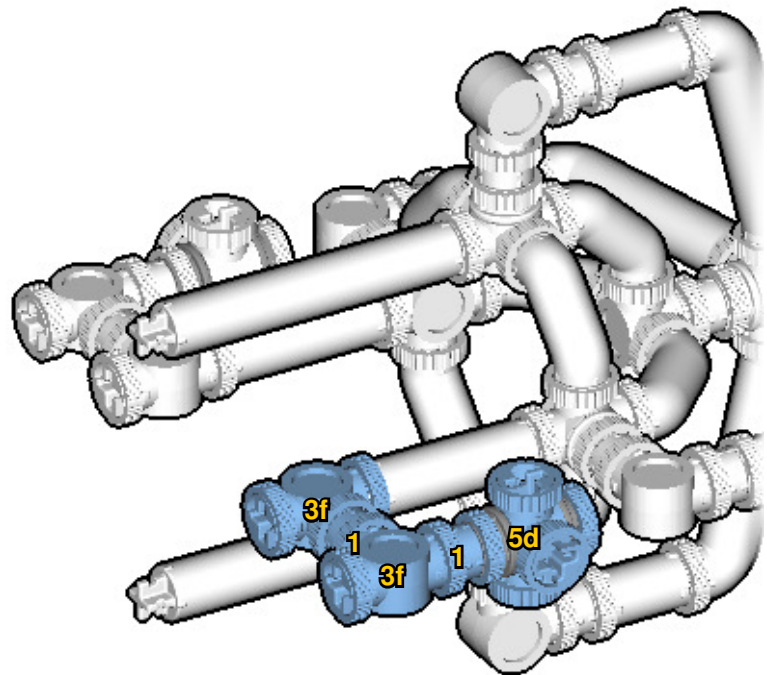

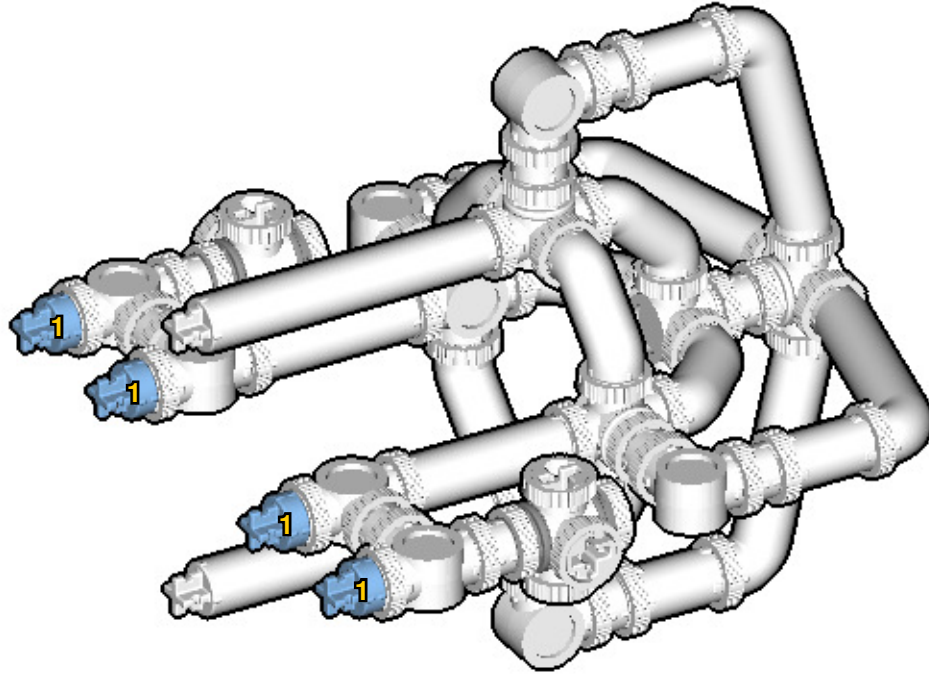

14

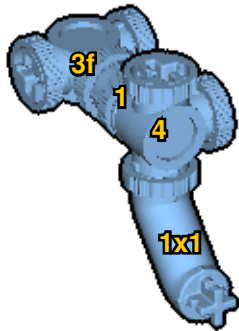

15

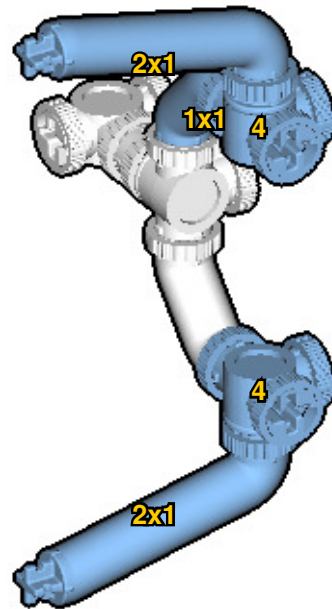

**16**

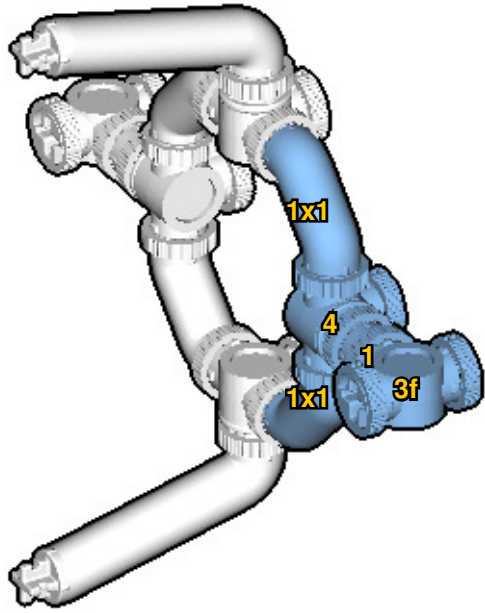

**17**

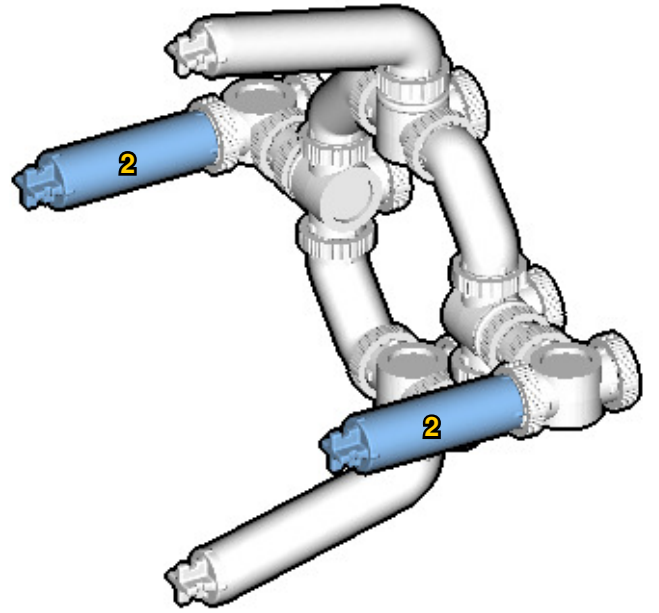

**18**

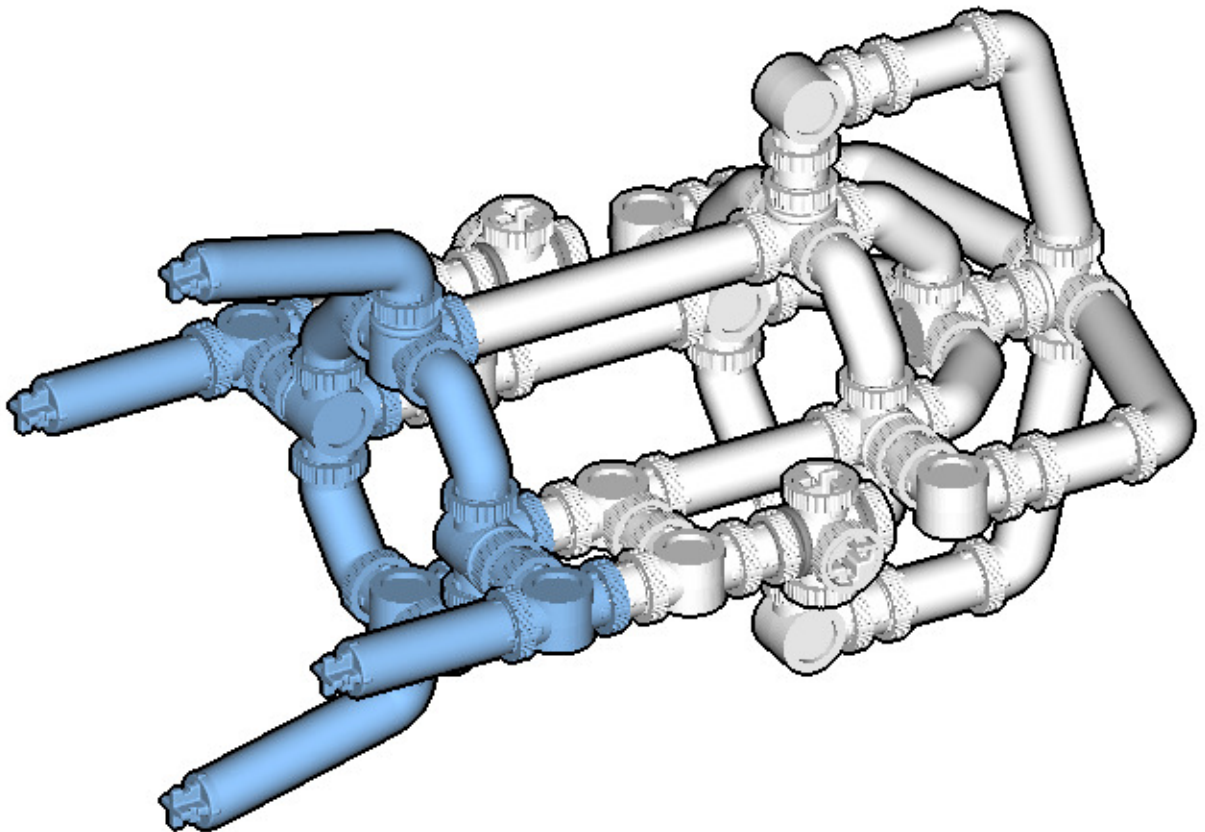



19



20

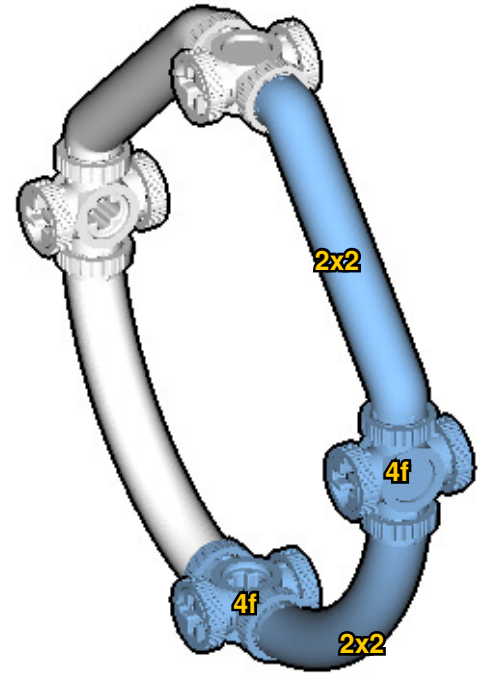

21

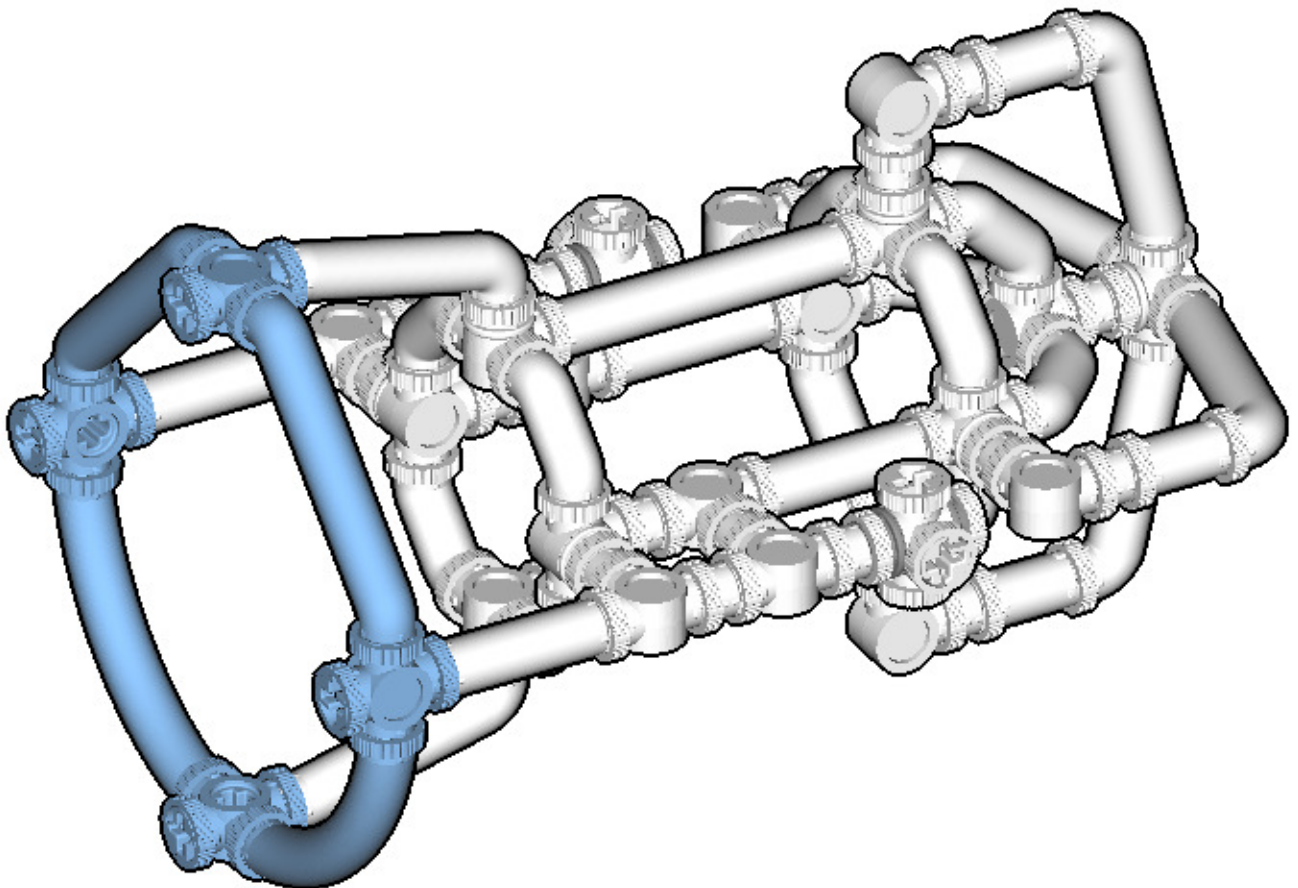



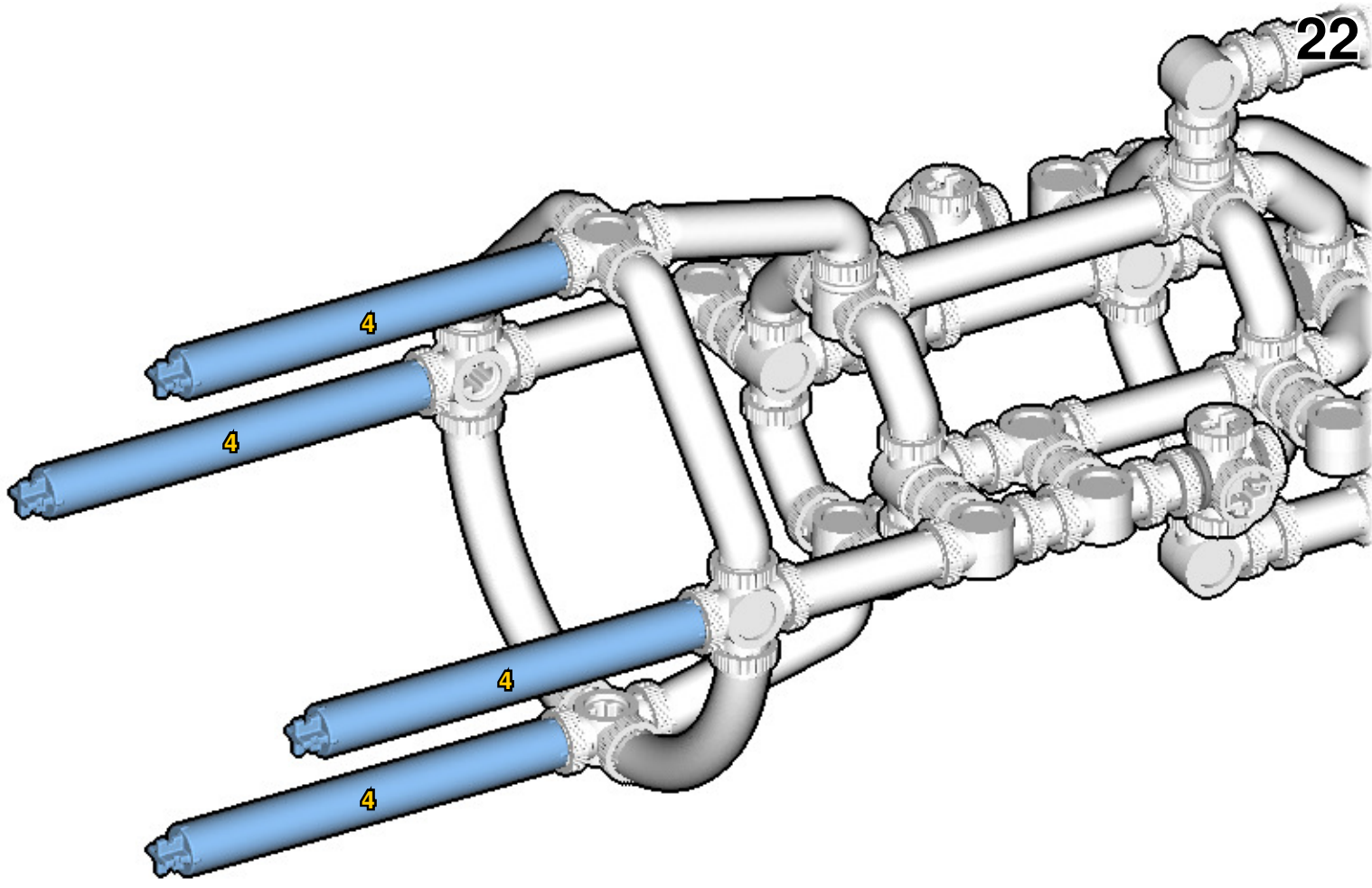

23



24

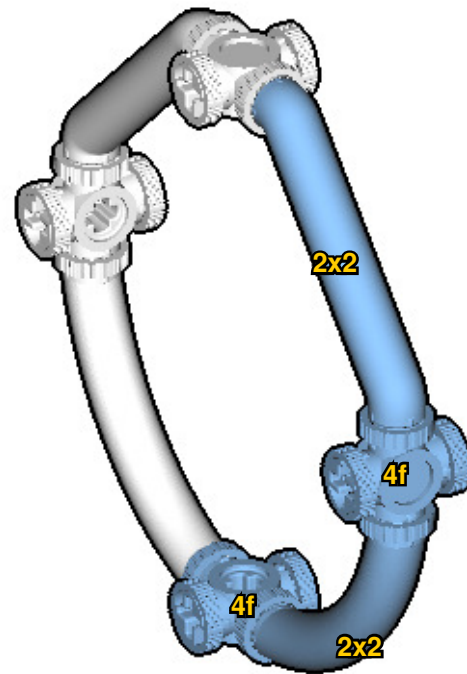

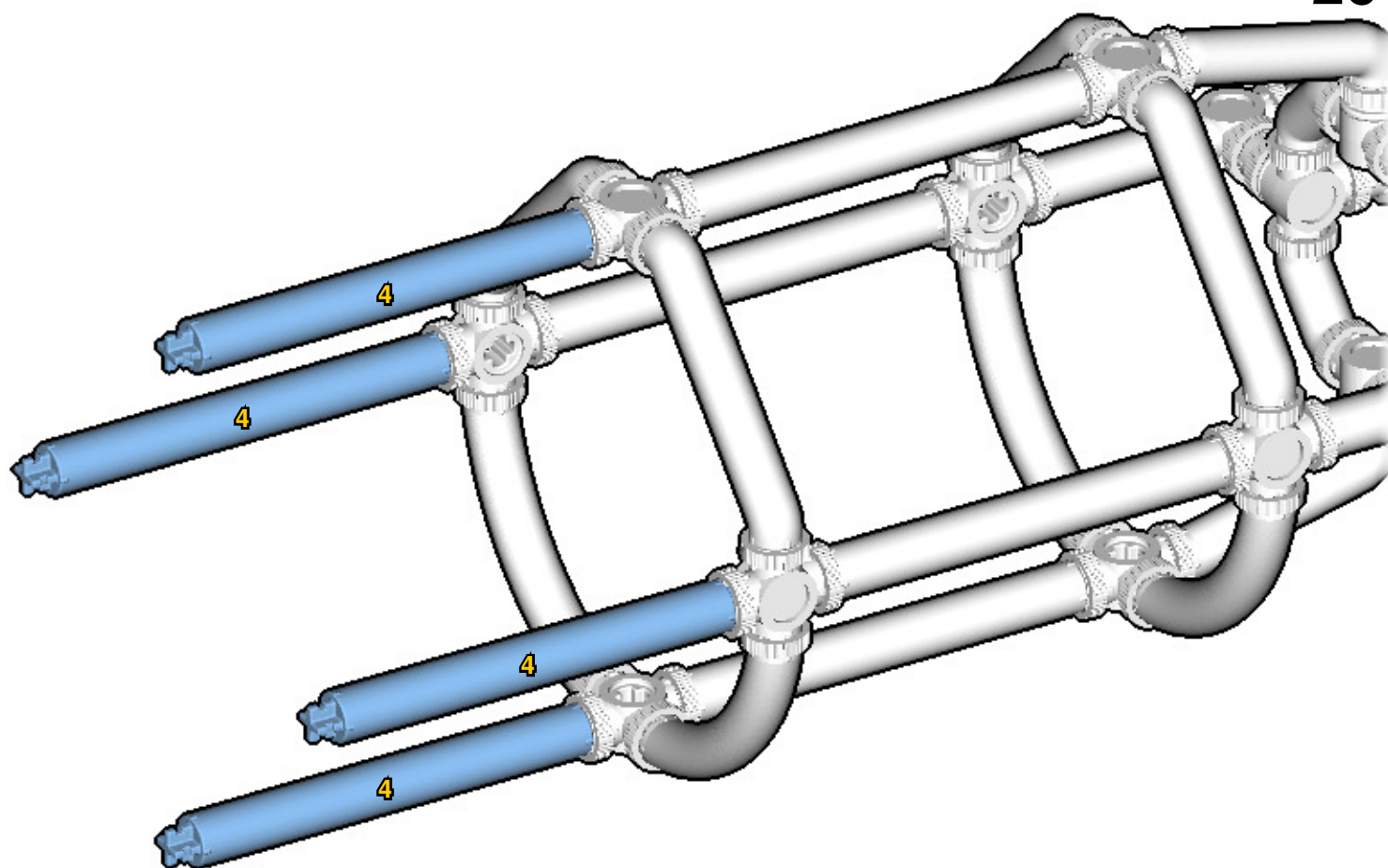
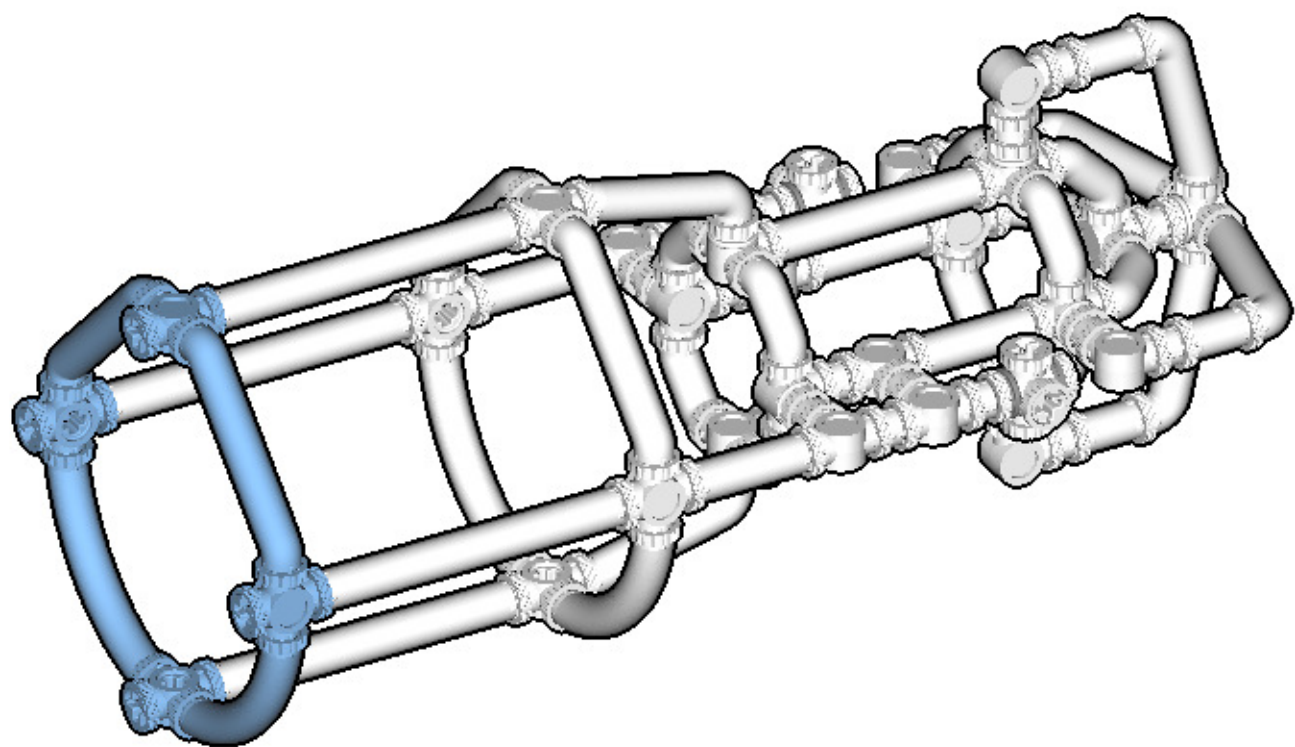

27



28

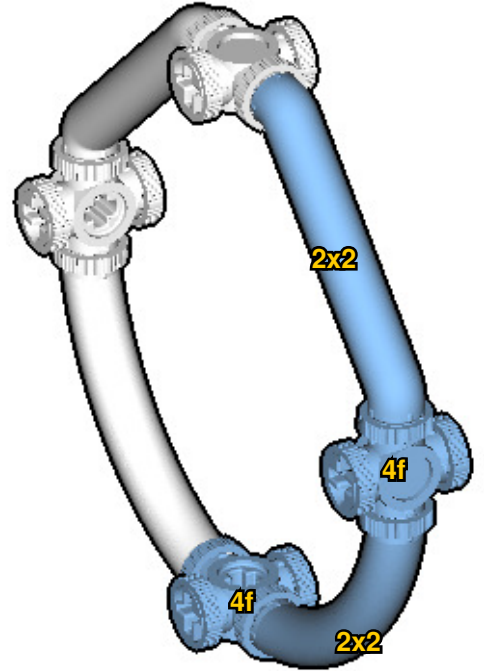

29

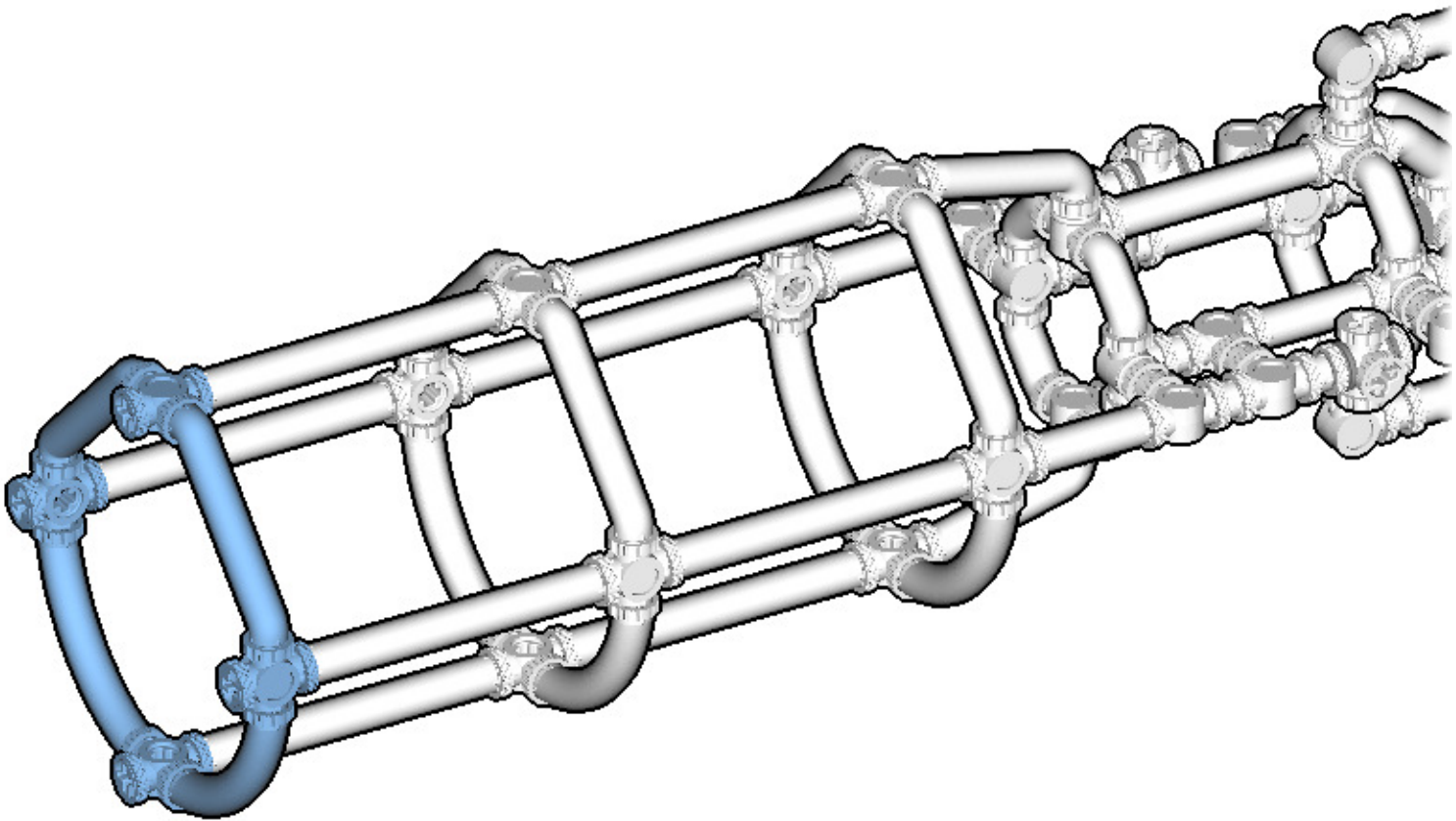

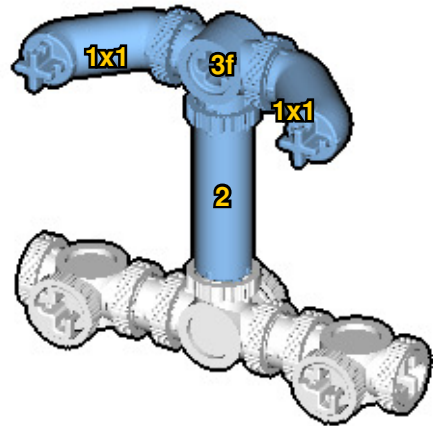
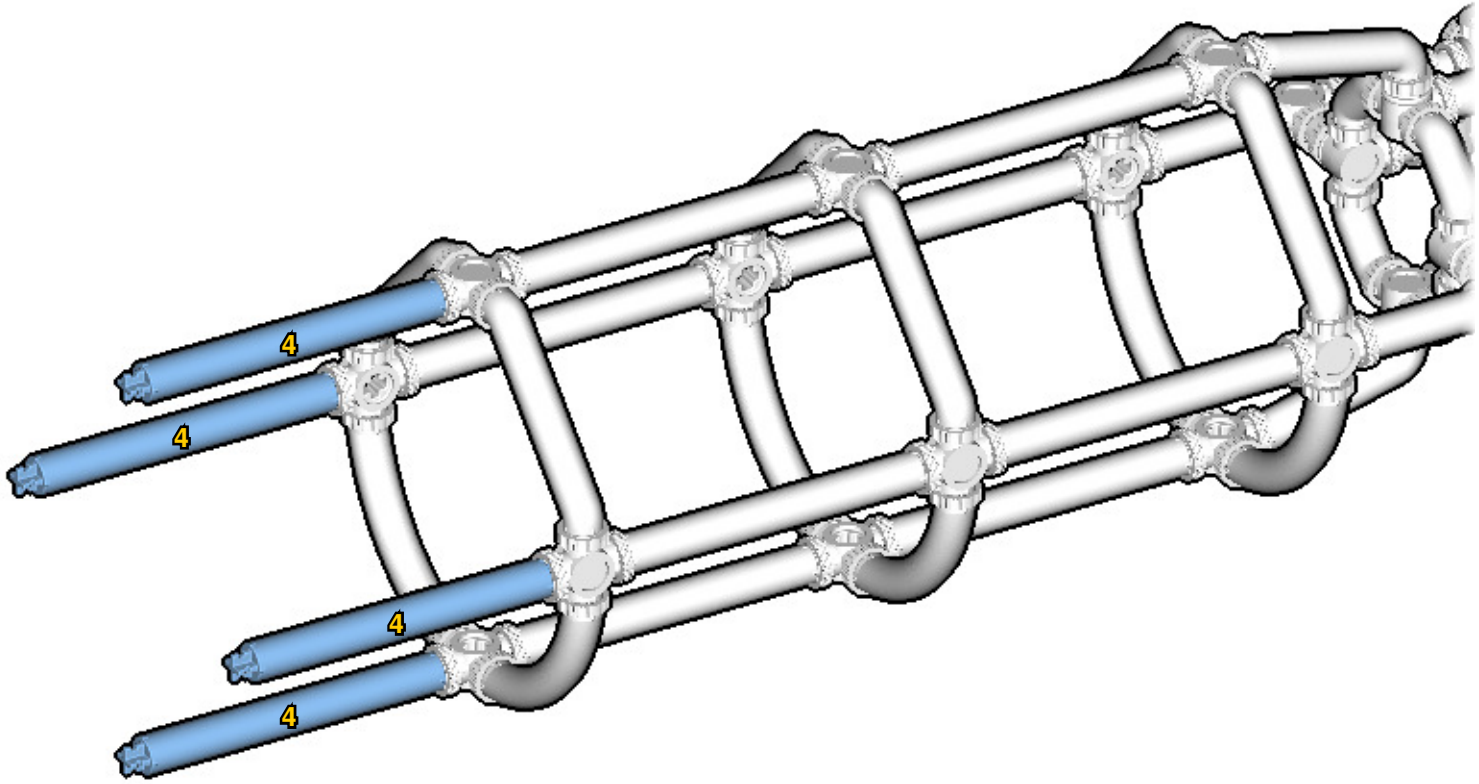



**33**

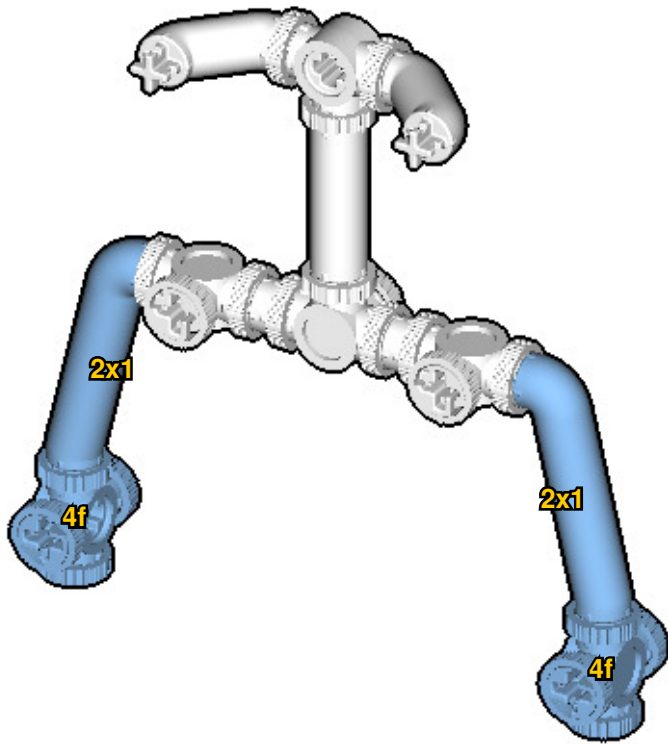

**34**

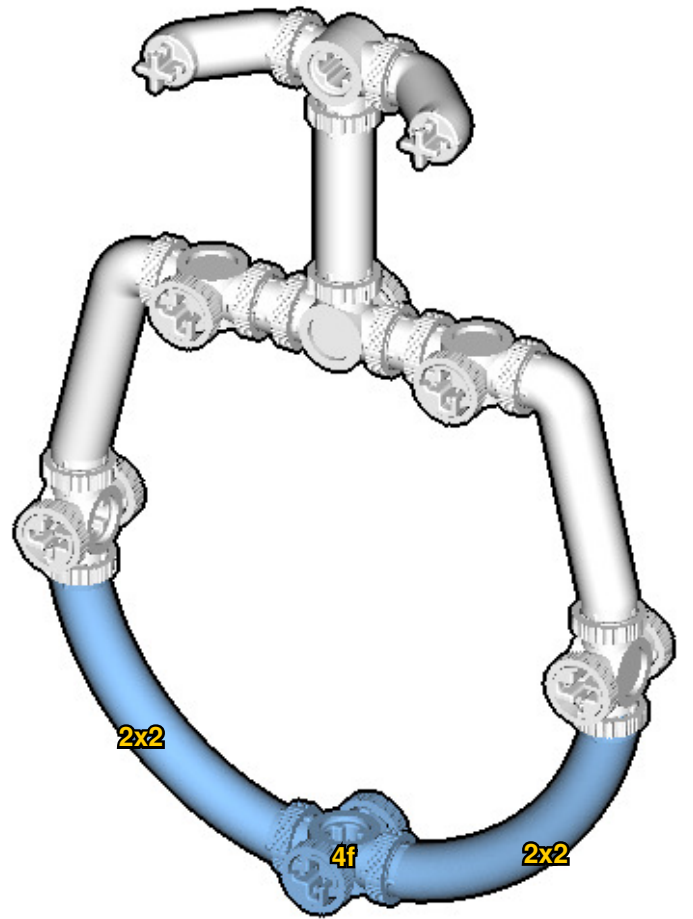

**35**

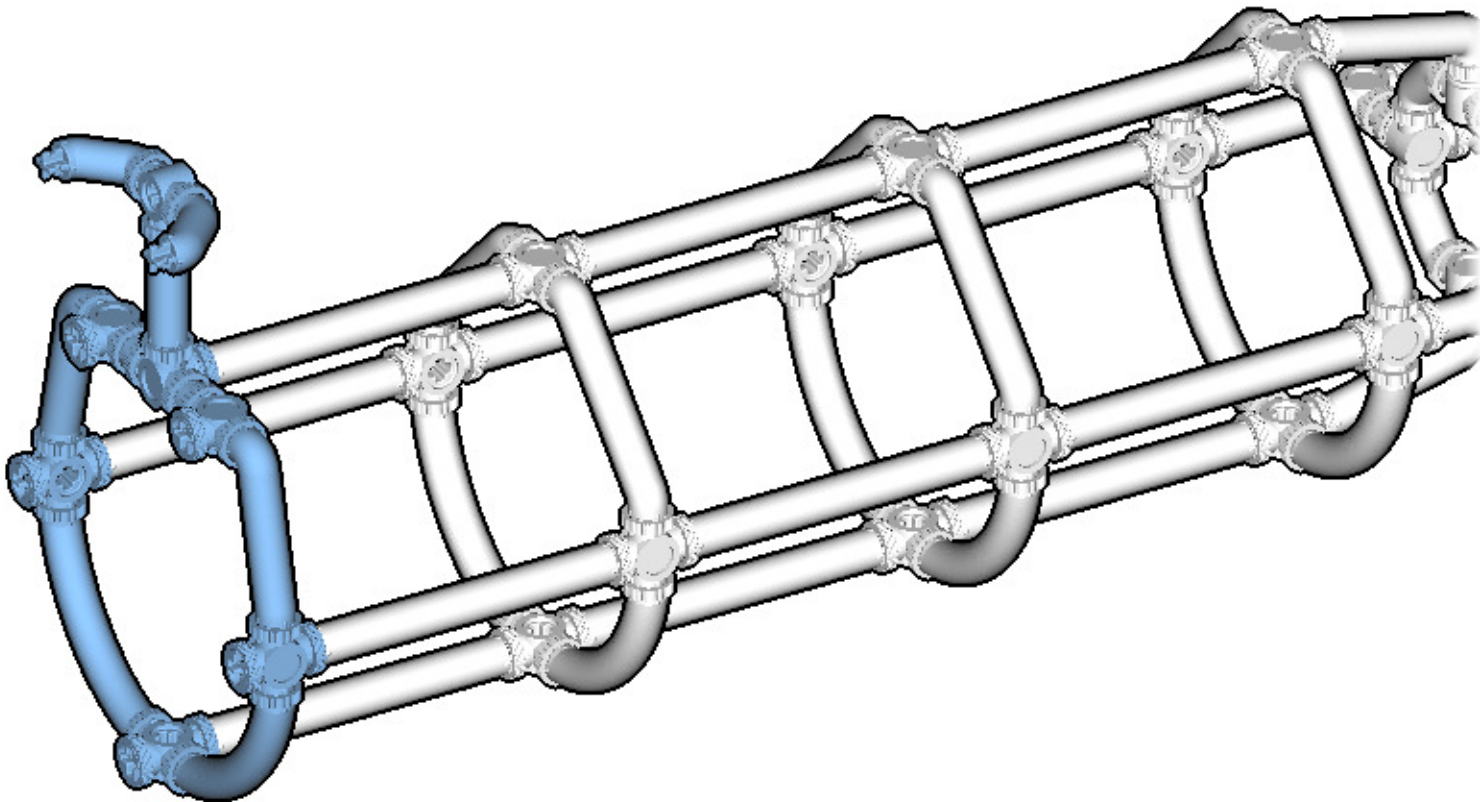

**36**

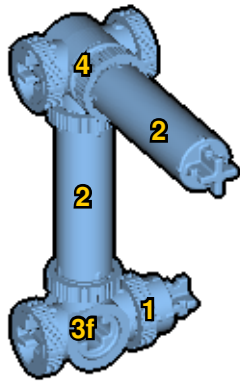

**37**

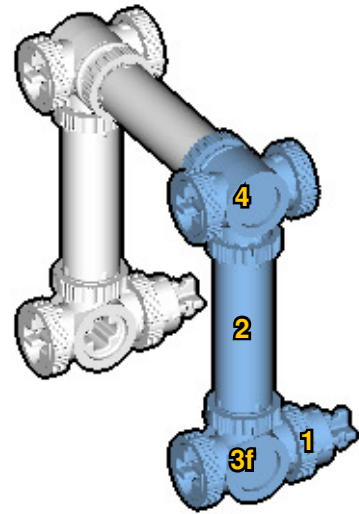

**38**

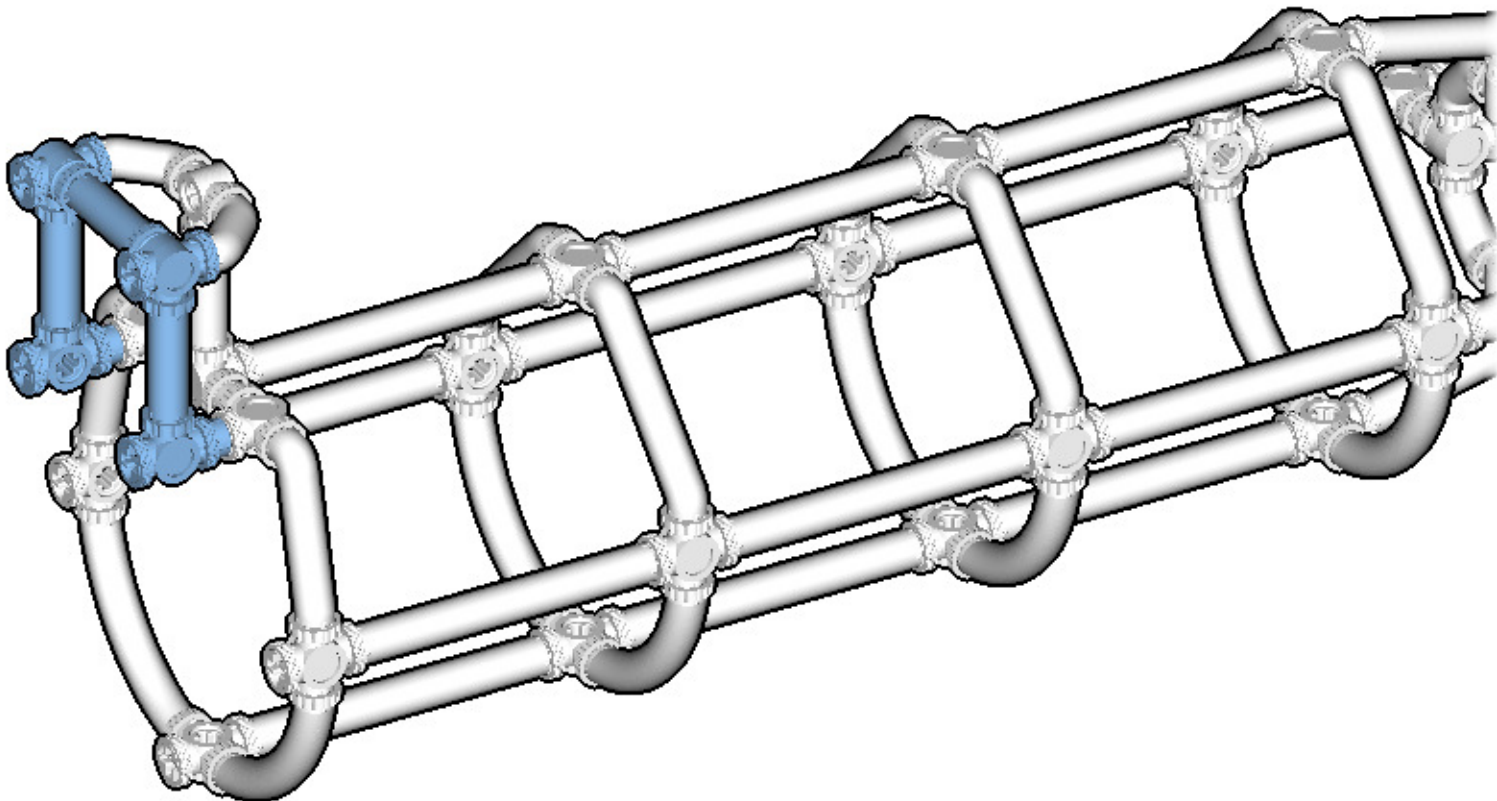

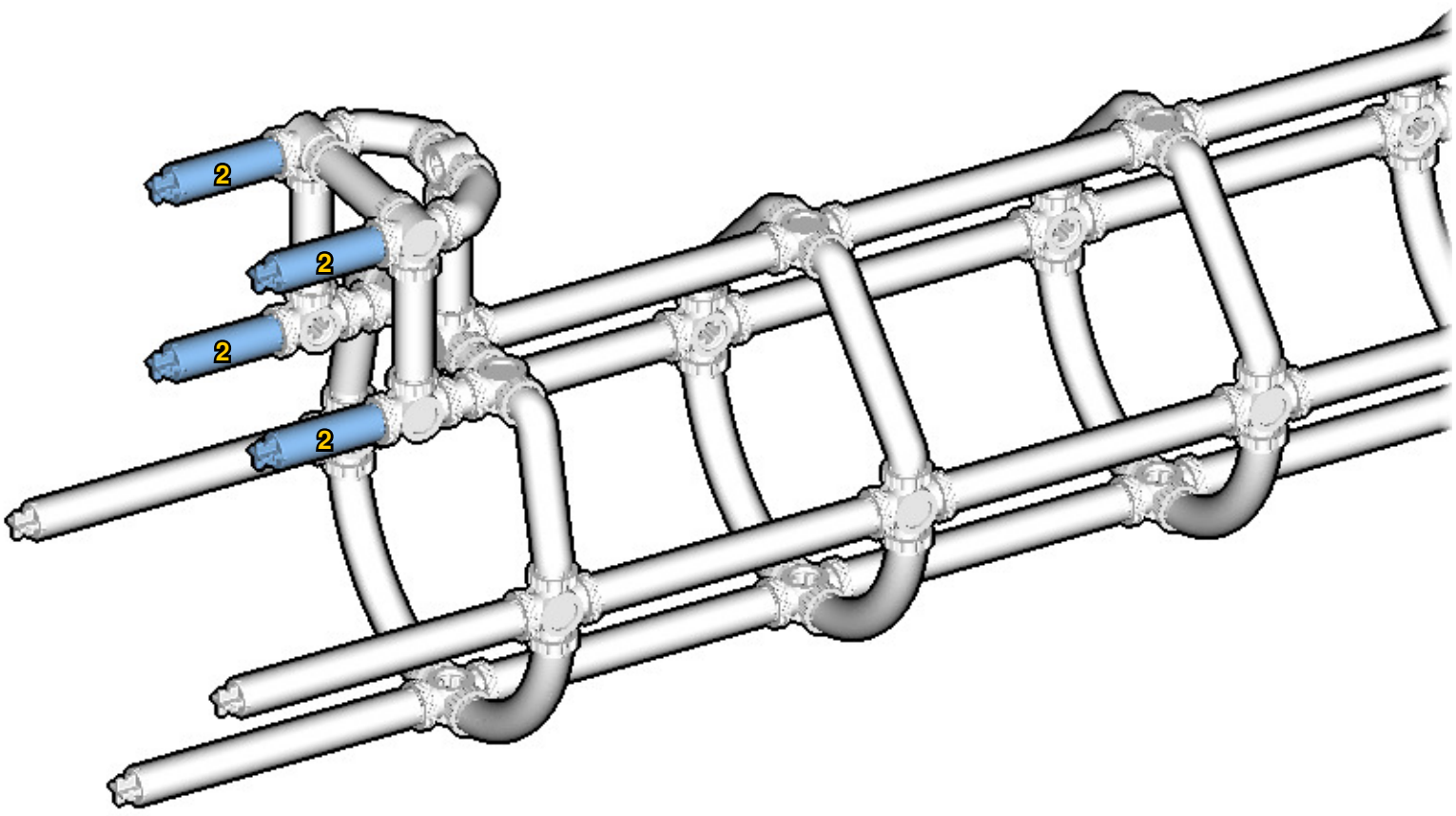
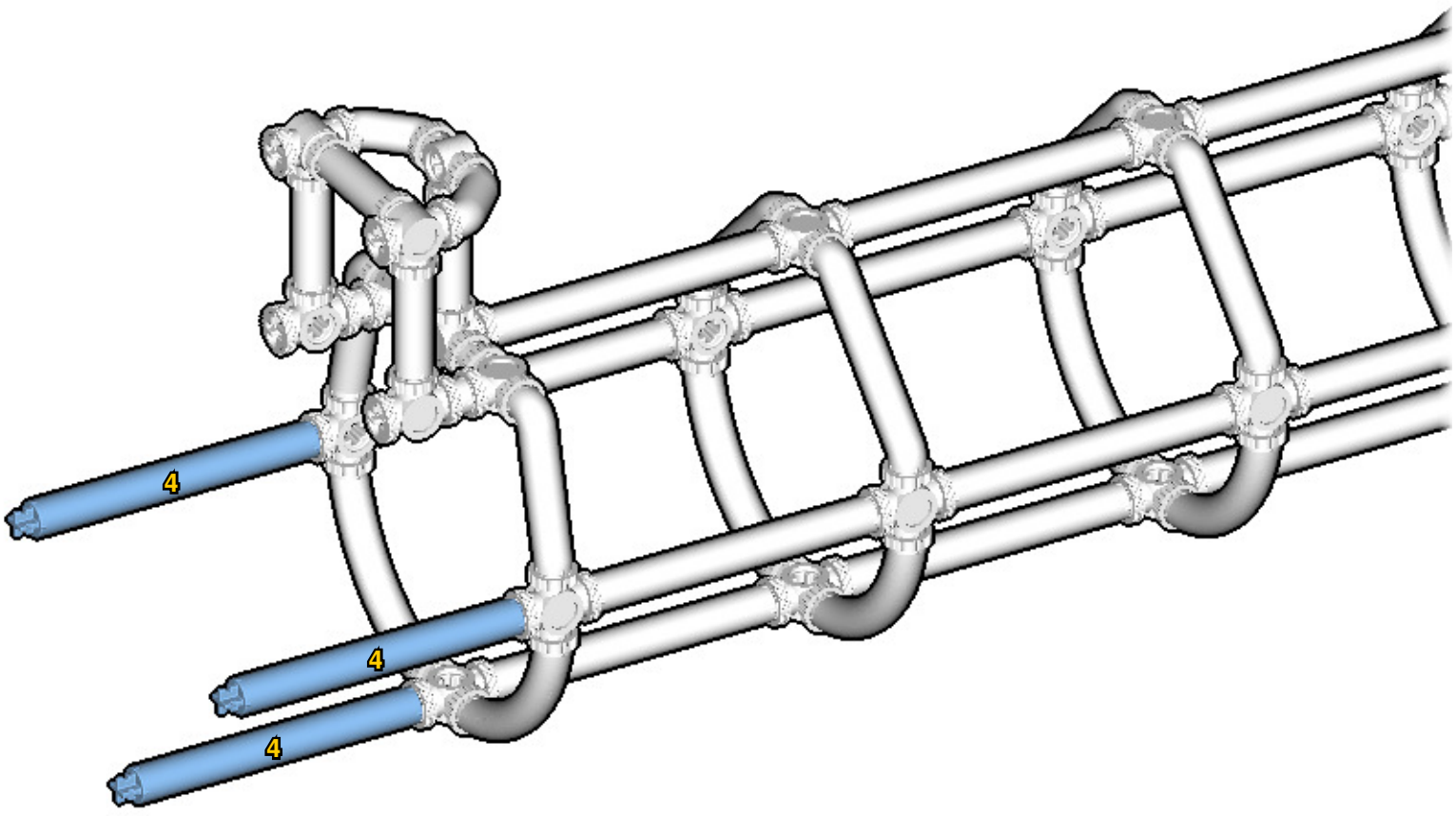

41

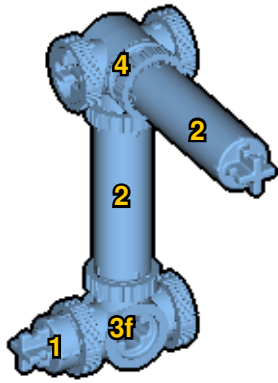

42

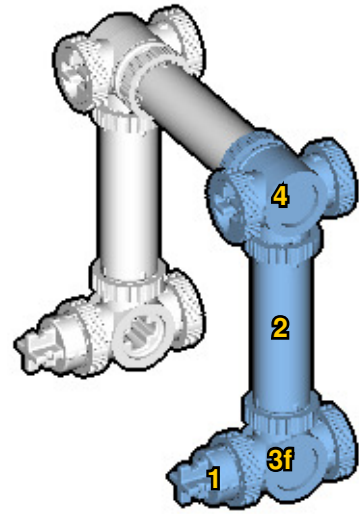

43

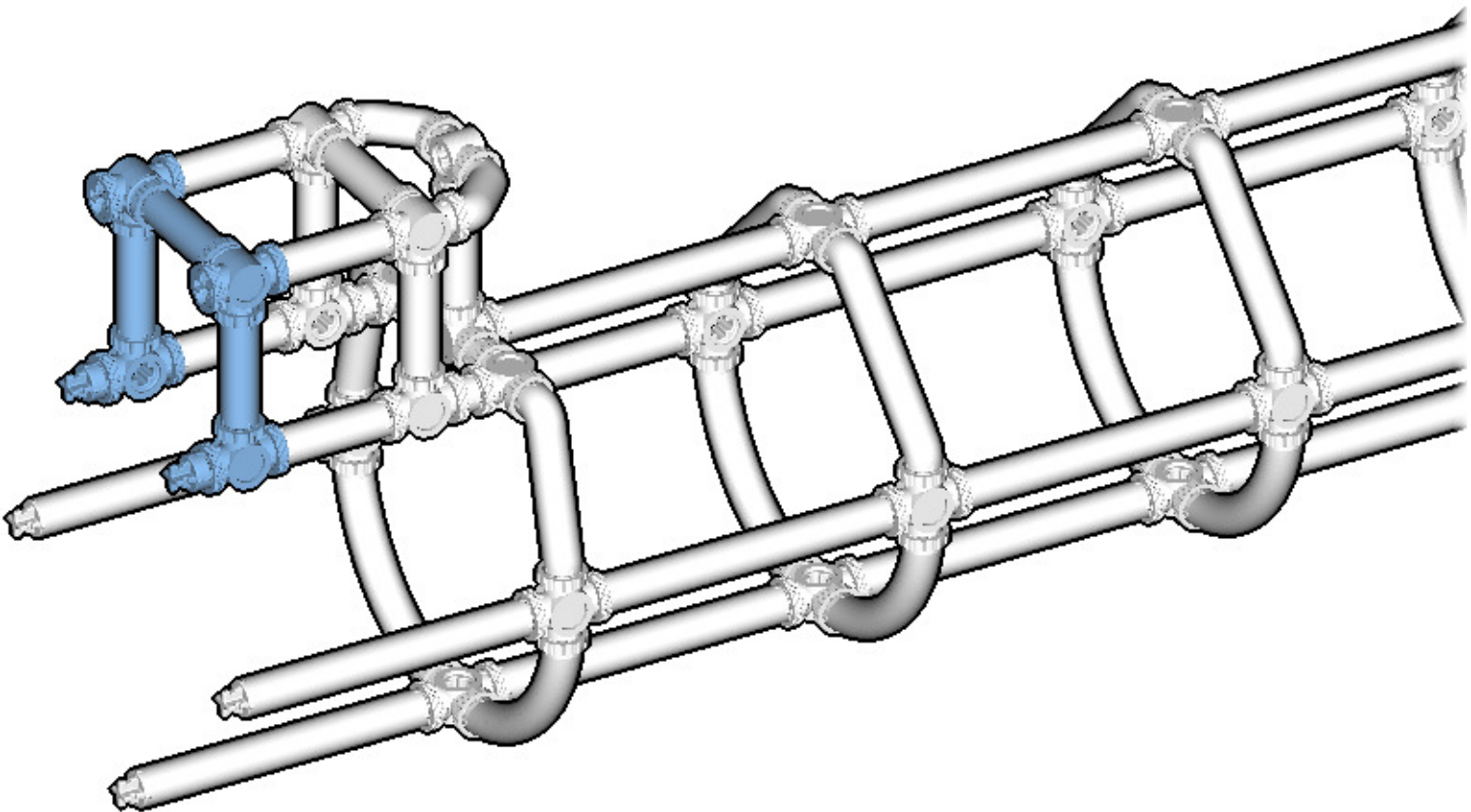



44

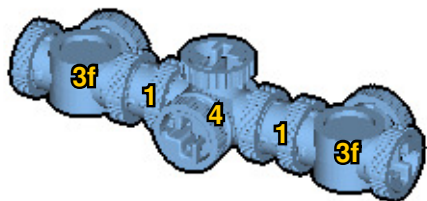

45

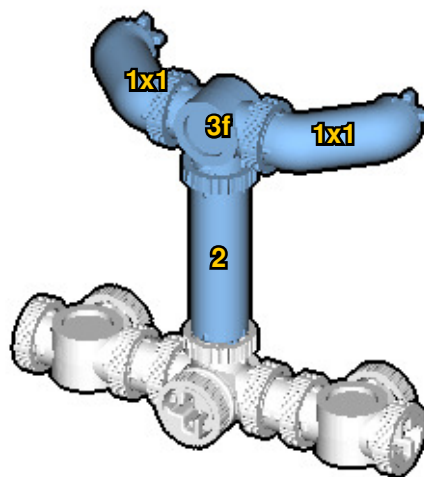

46

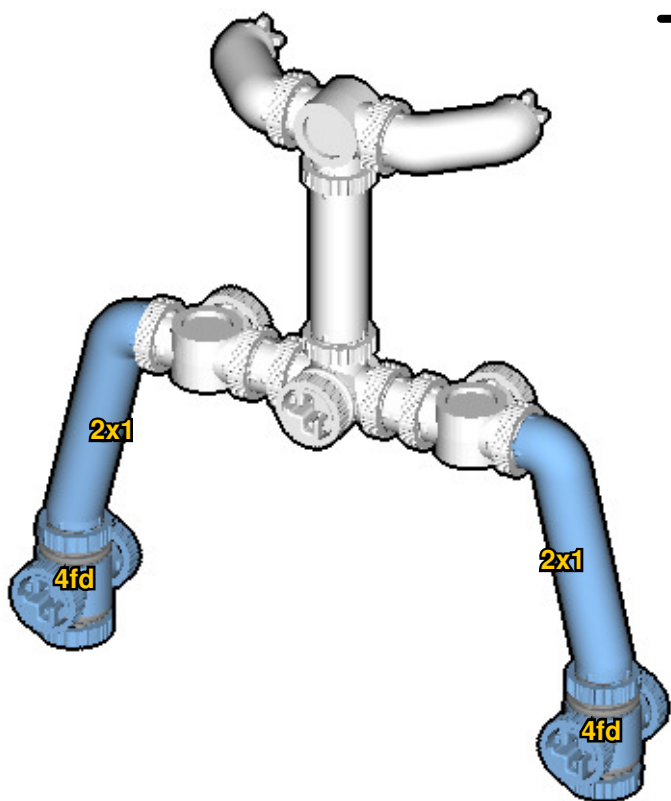

47

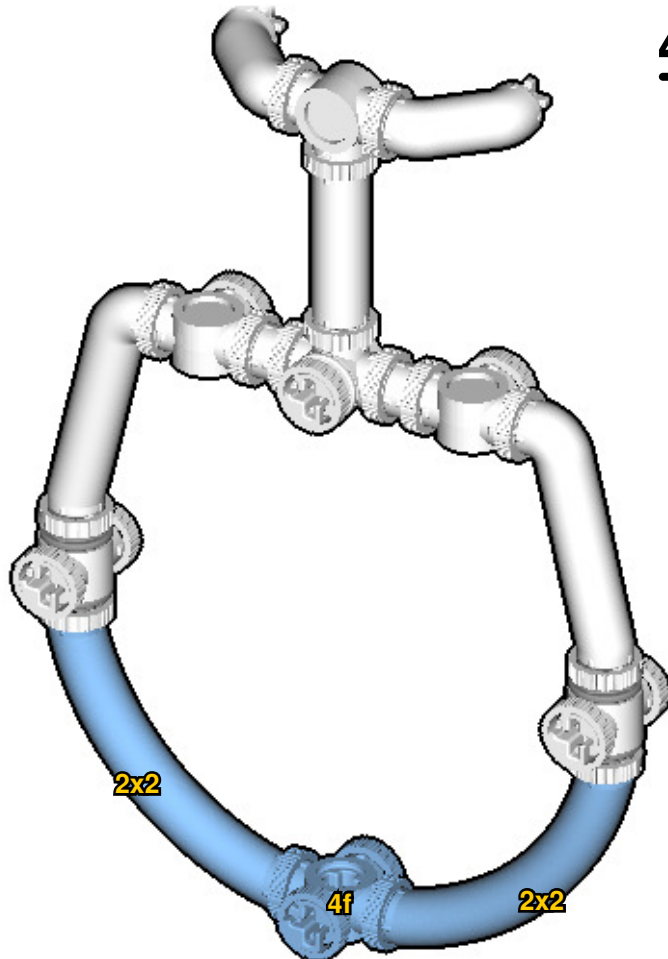

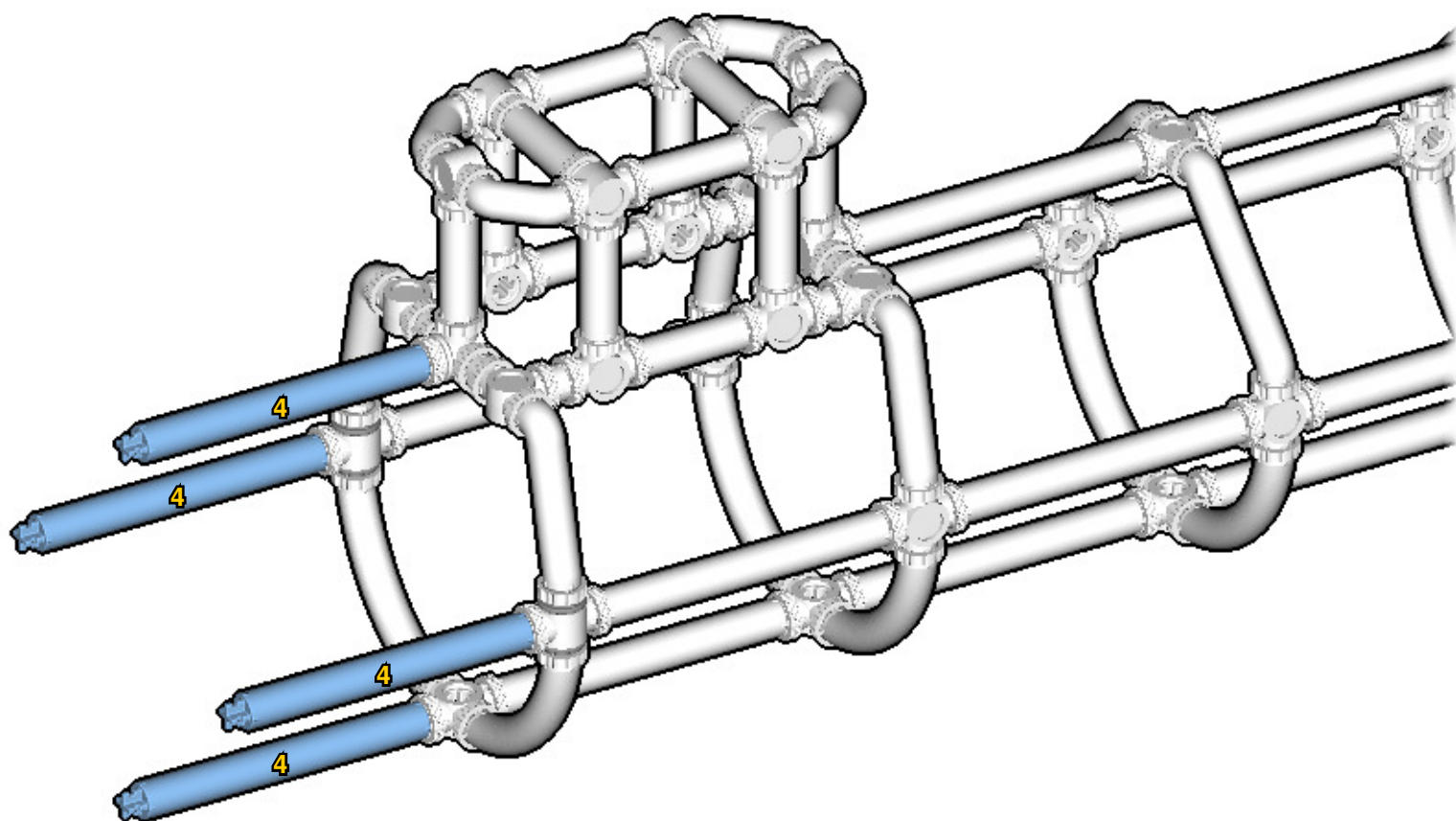
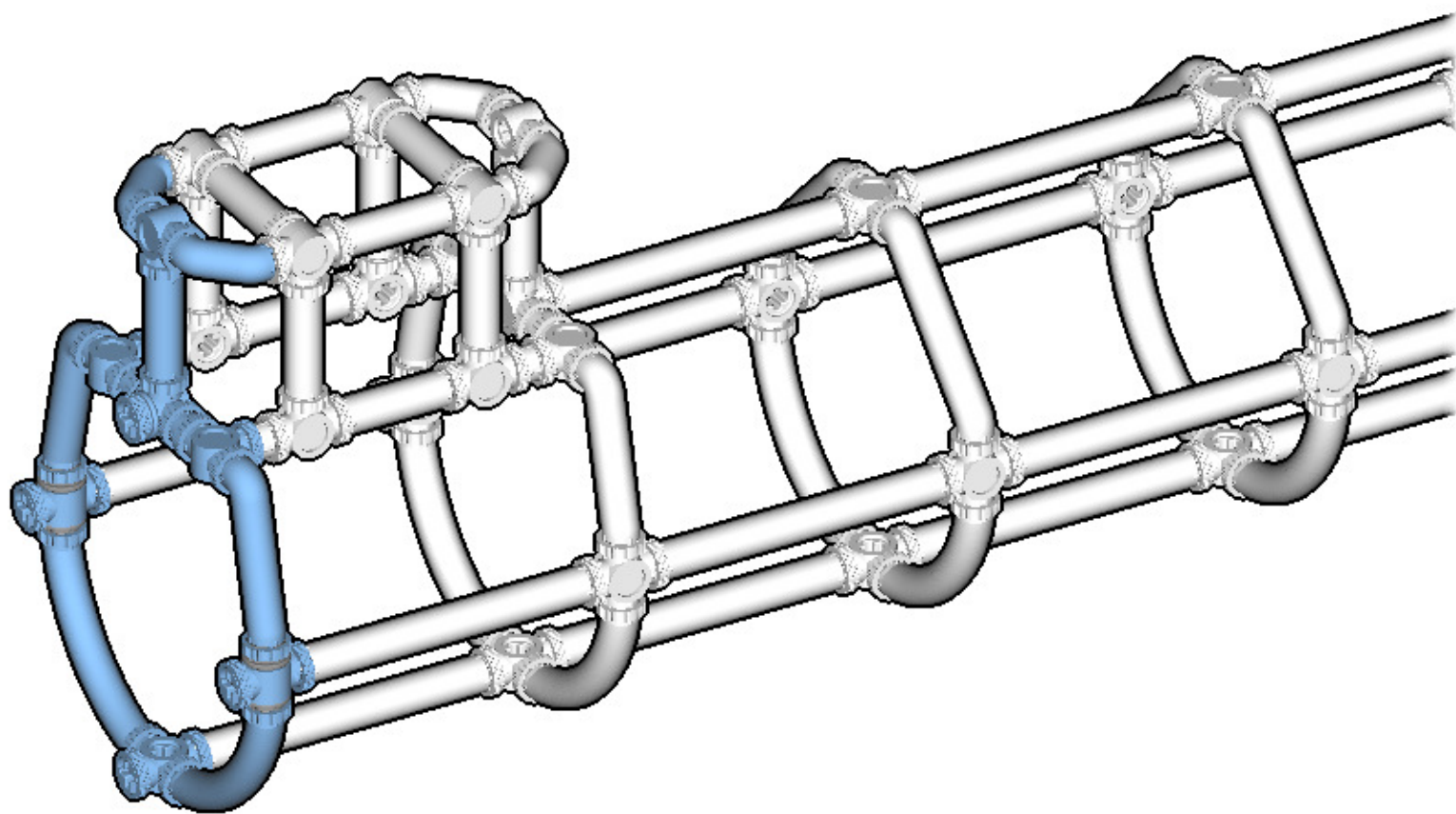

**50**



**51**

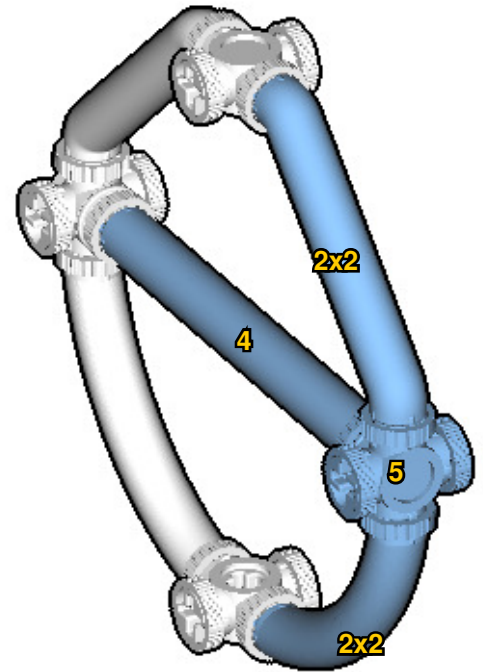

**52**

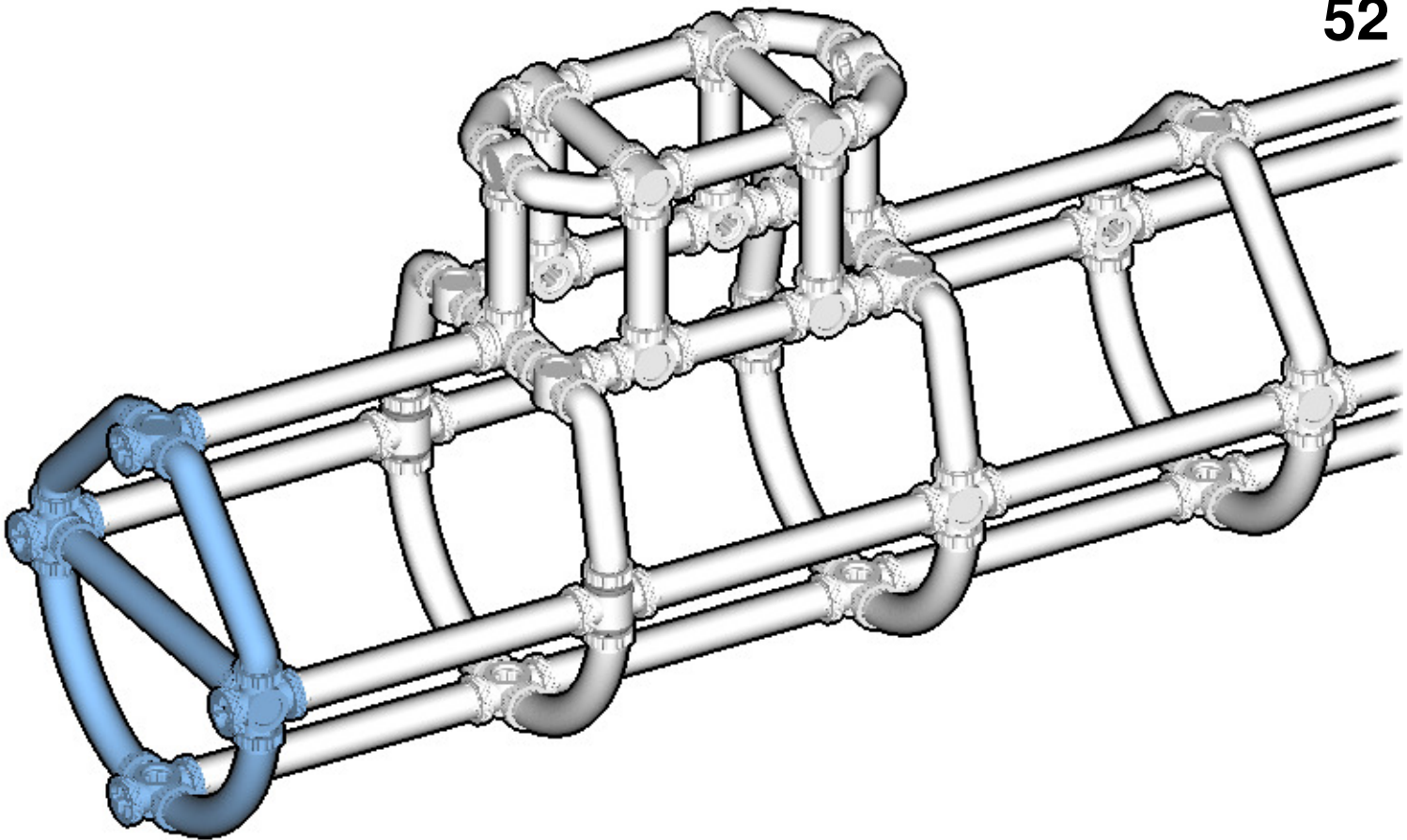

53

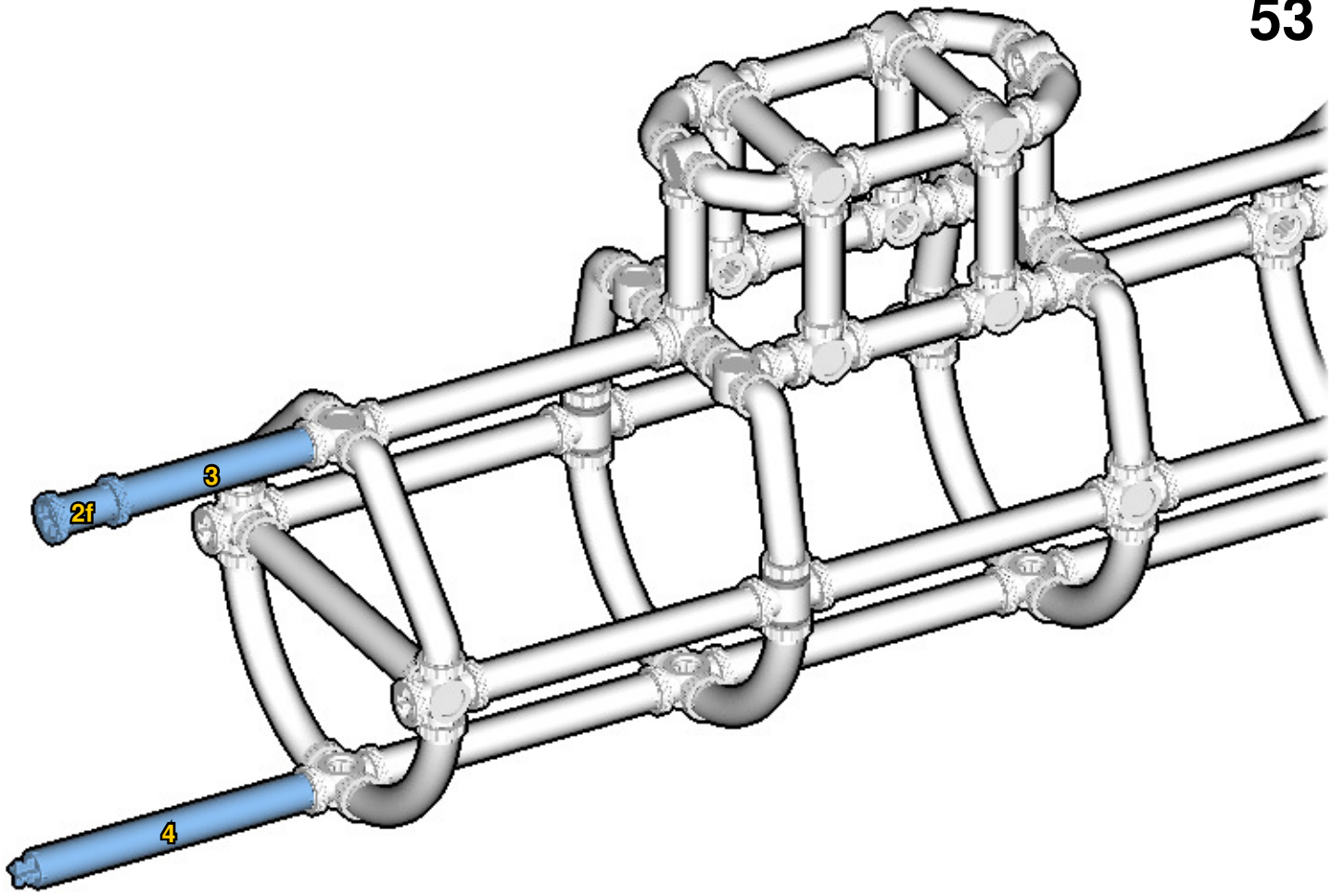

54

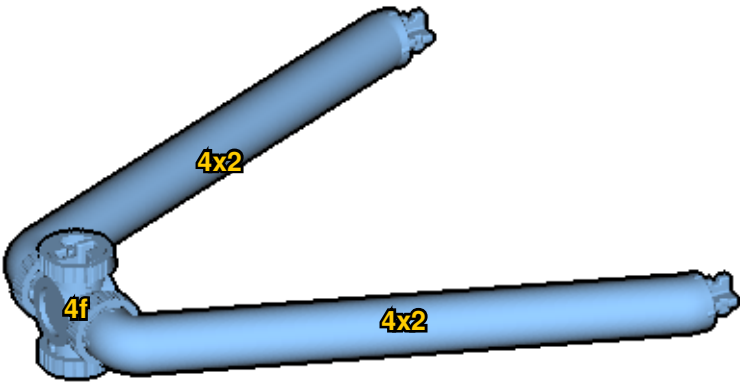

55

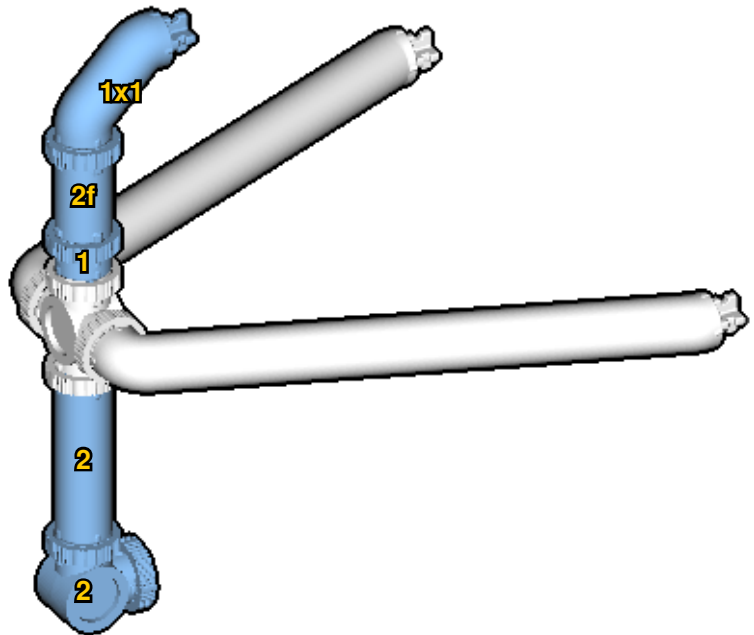



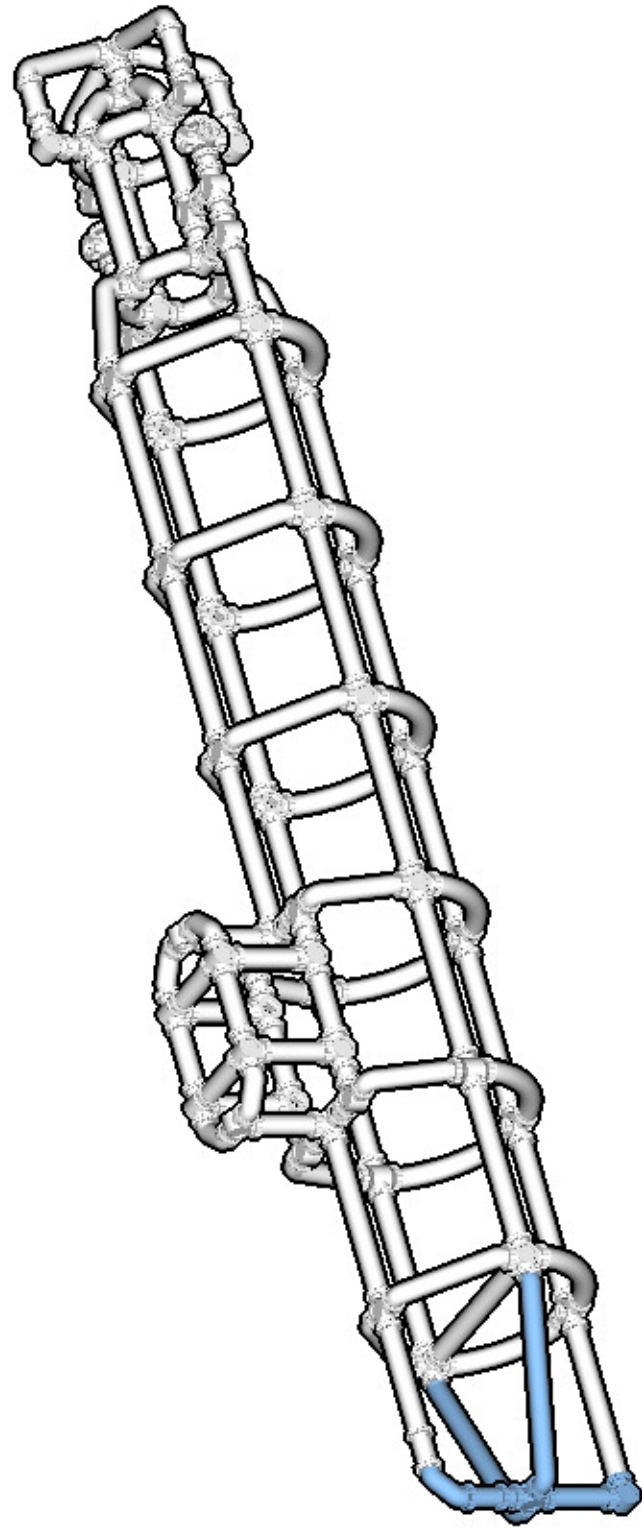

# INVENTORY

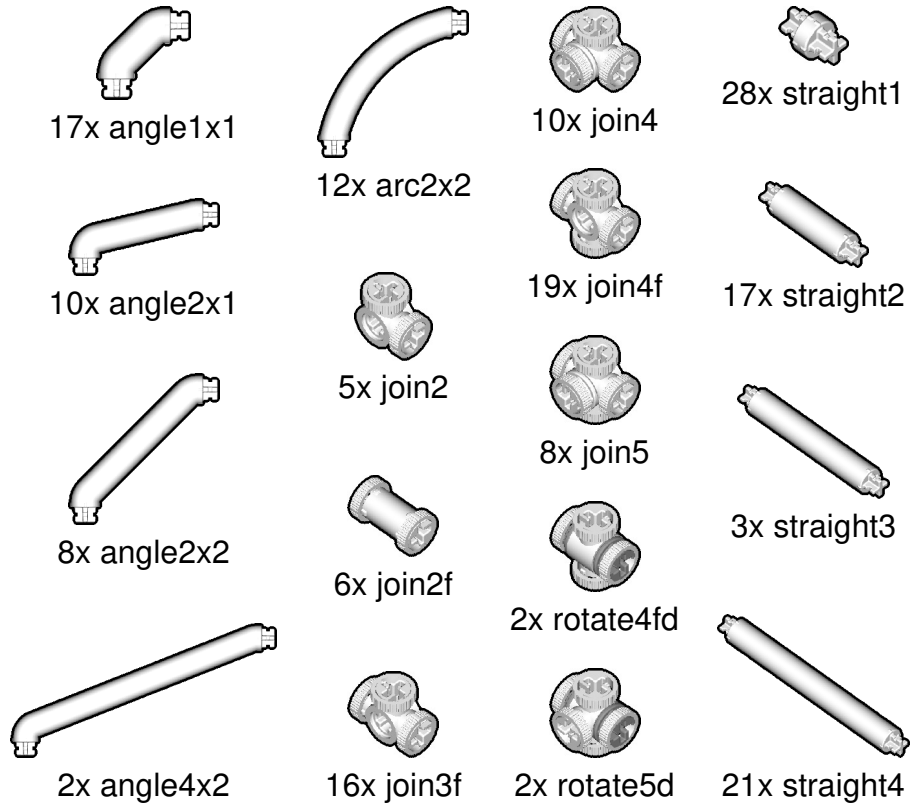

# ACTUAL SIZE

