

# TOURING BIKE

SIZE	1.6ft x 0.8ft x 0.6ft	PIECES	310
DESIGNER	Charles Sharman	MADE IN	U.S.A.

⚠ WARNING: Small parts. Age 14+. Not a toy. Handle responsibly. U.S. Patent 9,086,087.



Wrong  
Connecting/Disconnecting Two Directions



Right  
Connecting/Disconnecting One Direction

1



New pieces are drawn blue. Old pieces are drawn white.  
See back for piece names.

2

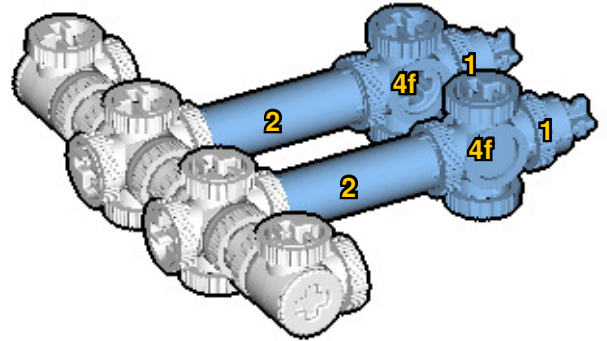

Connect new pieces together before connecting to old pieces.

3

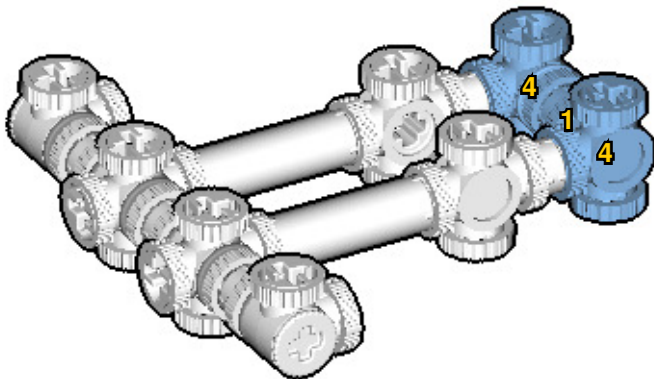

4

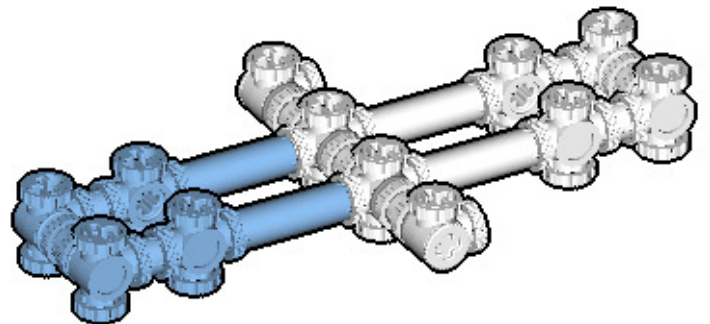

 : Copy new pieces from old pieces.

Submodel begins → **5**

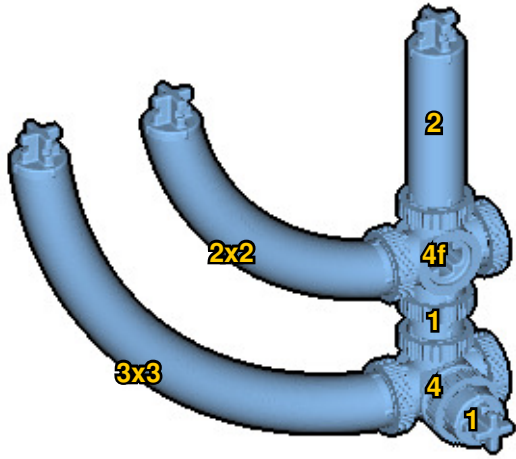

**6**

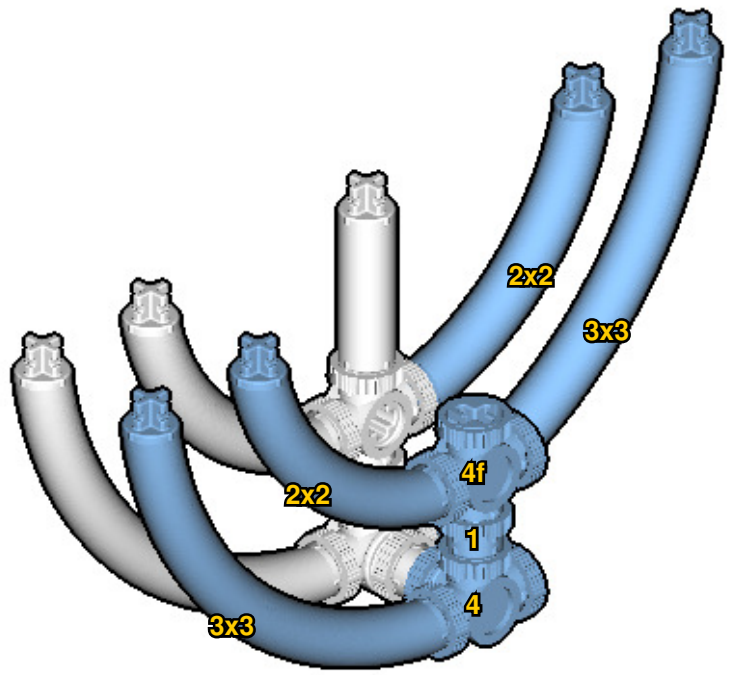

**7**

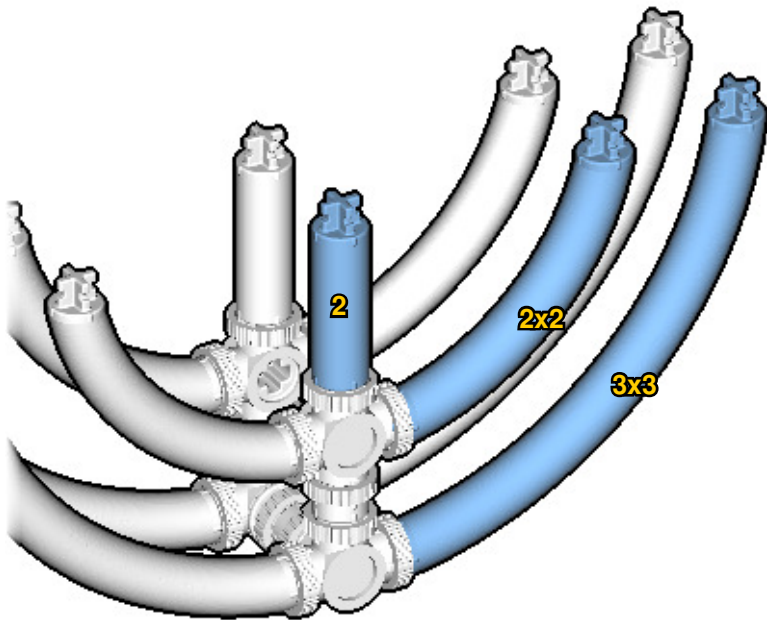

Submodel ends → **8**

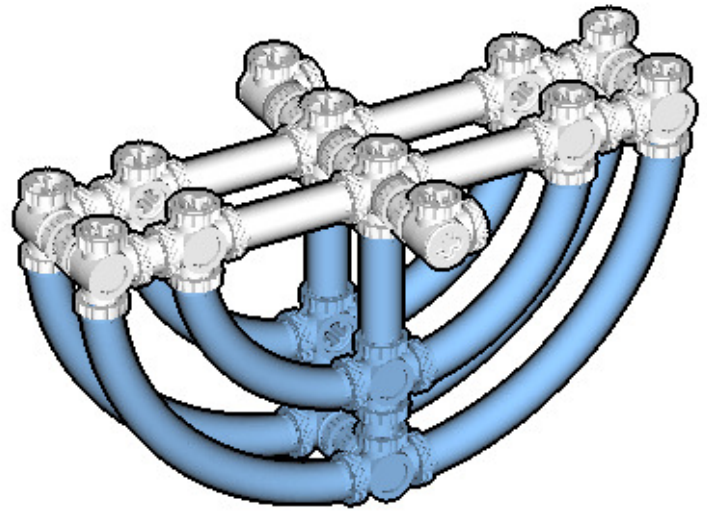

Connect submodel to model.

9

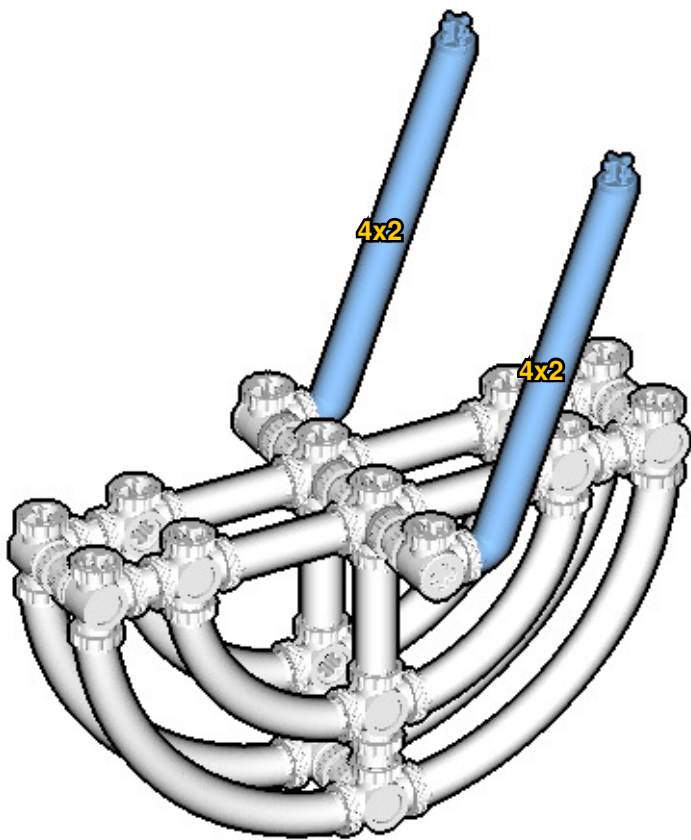

10

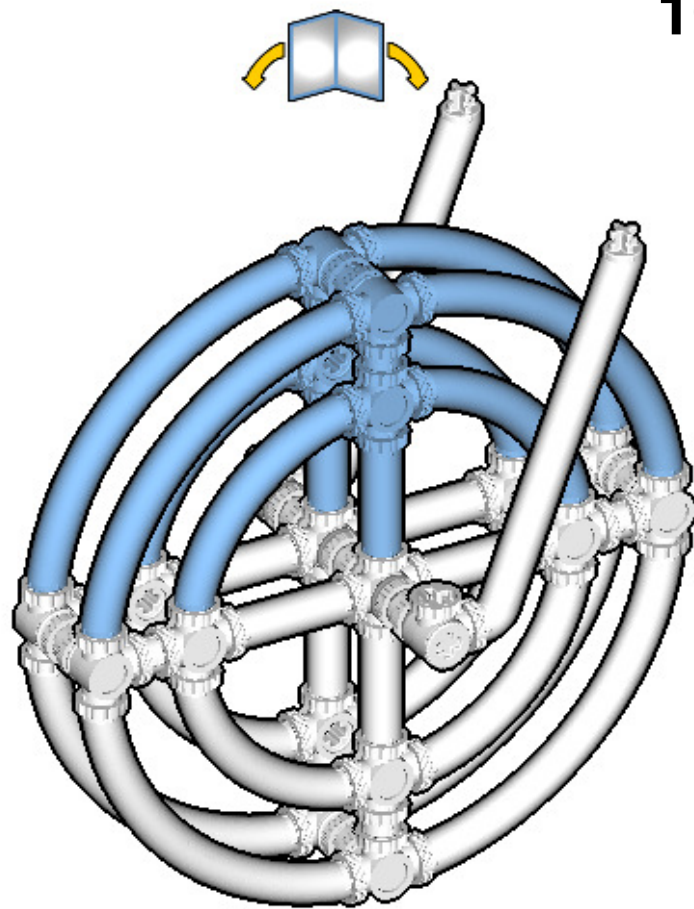

11

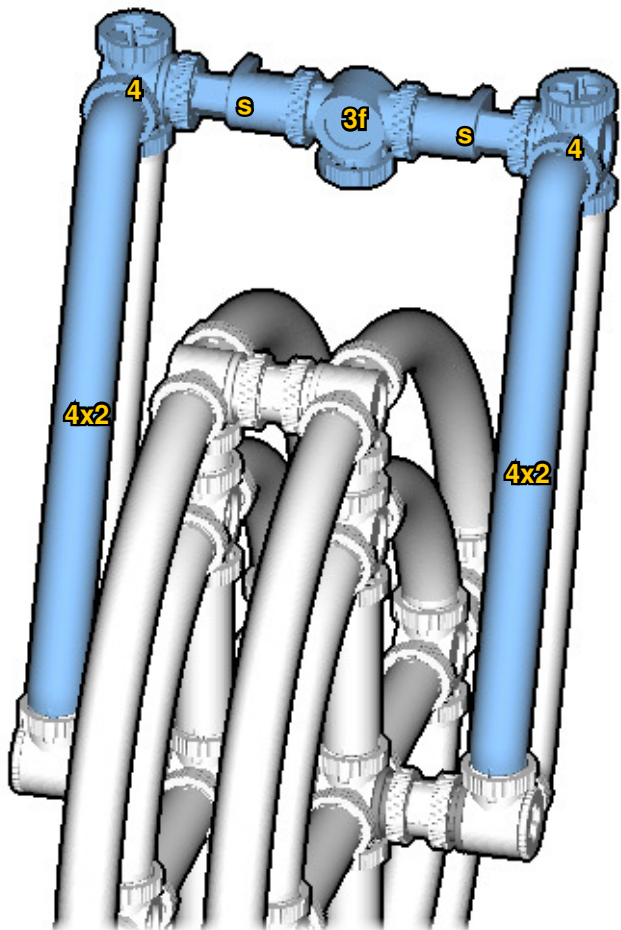

12

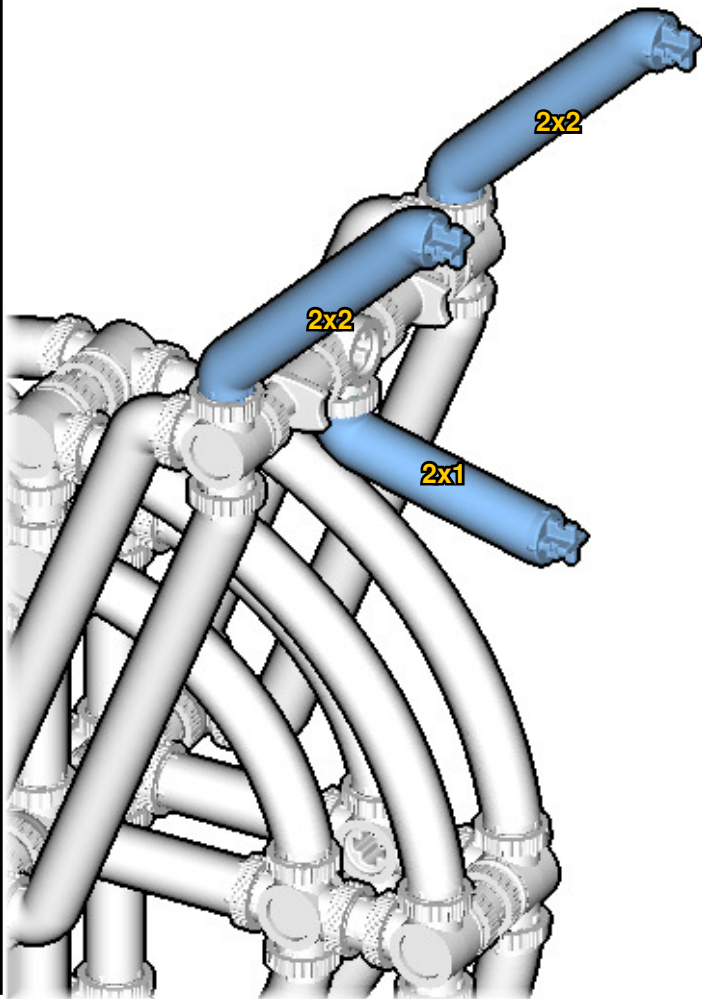

13

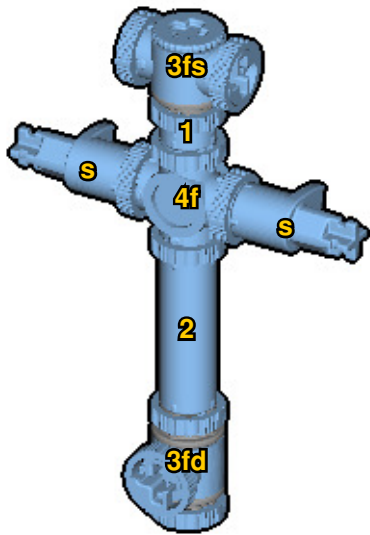

14

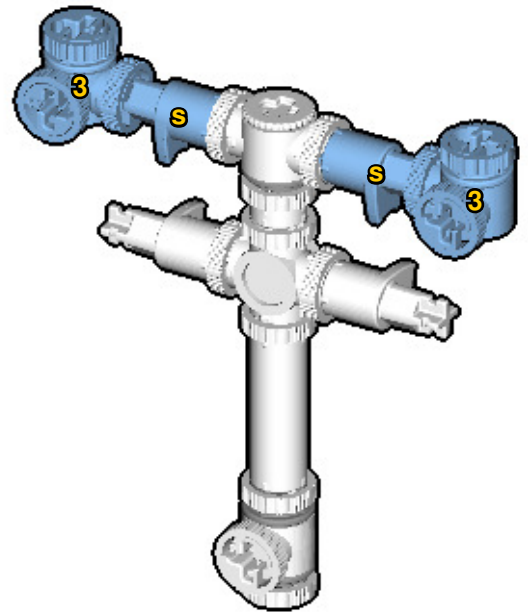

15

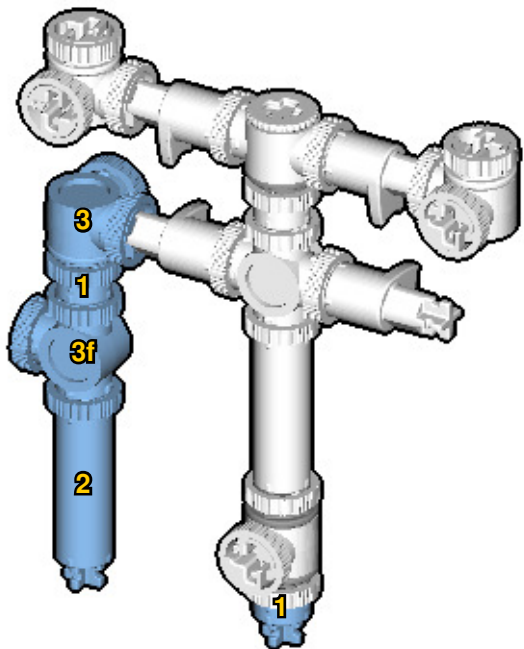

16

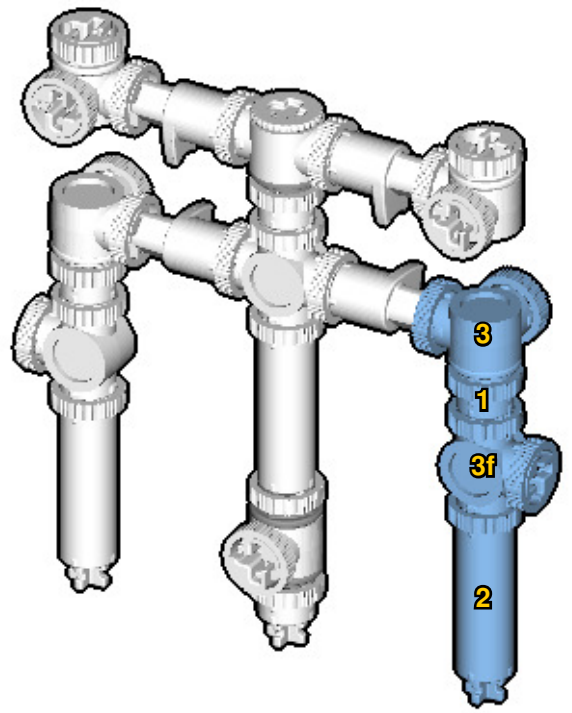

17

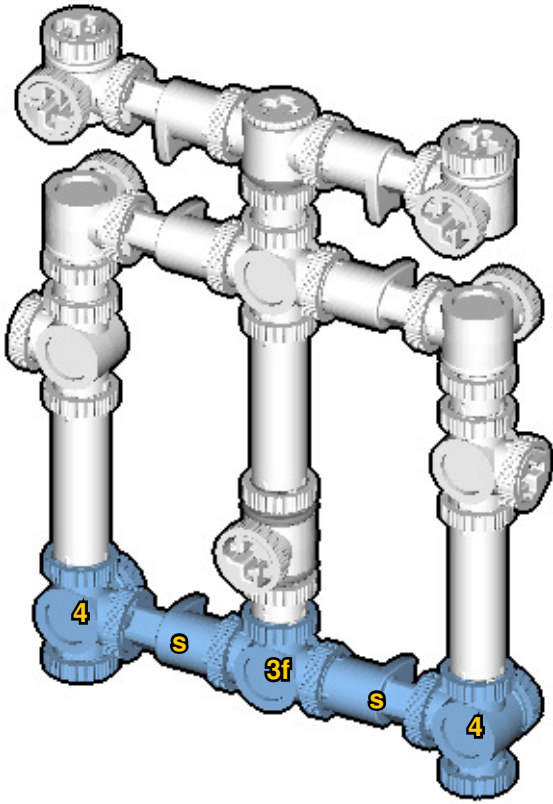

18

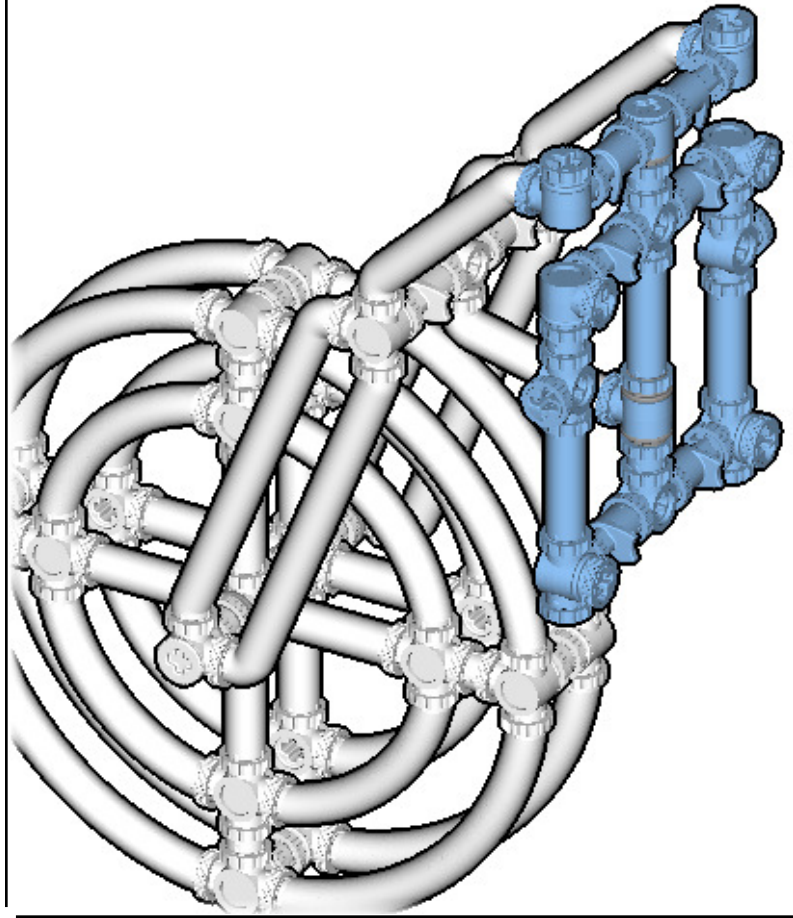

19

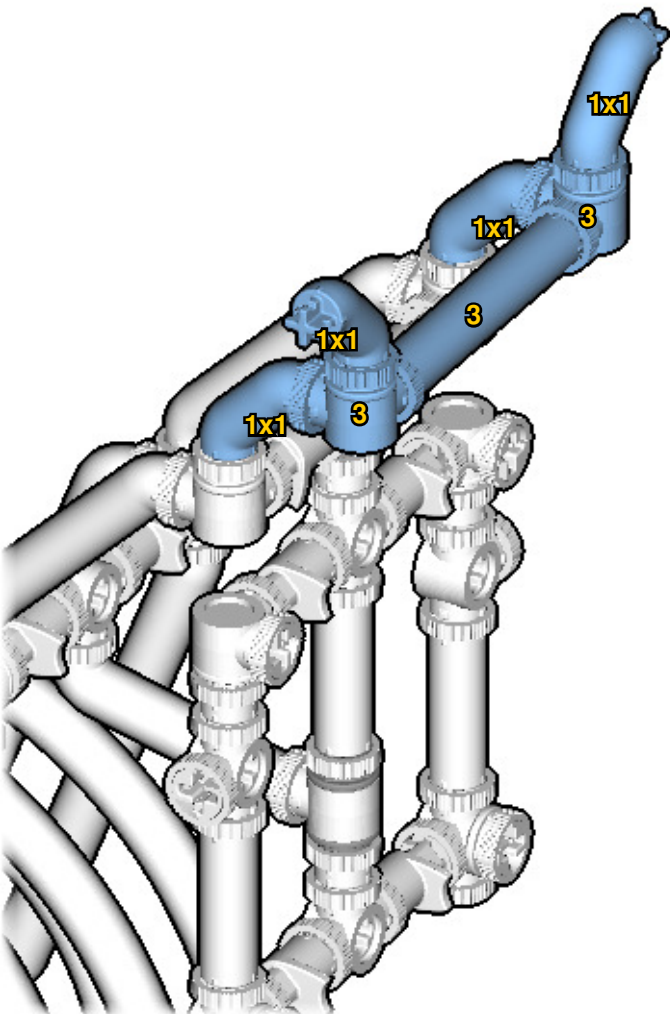

20

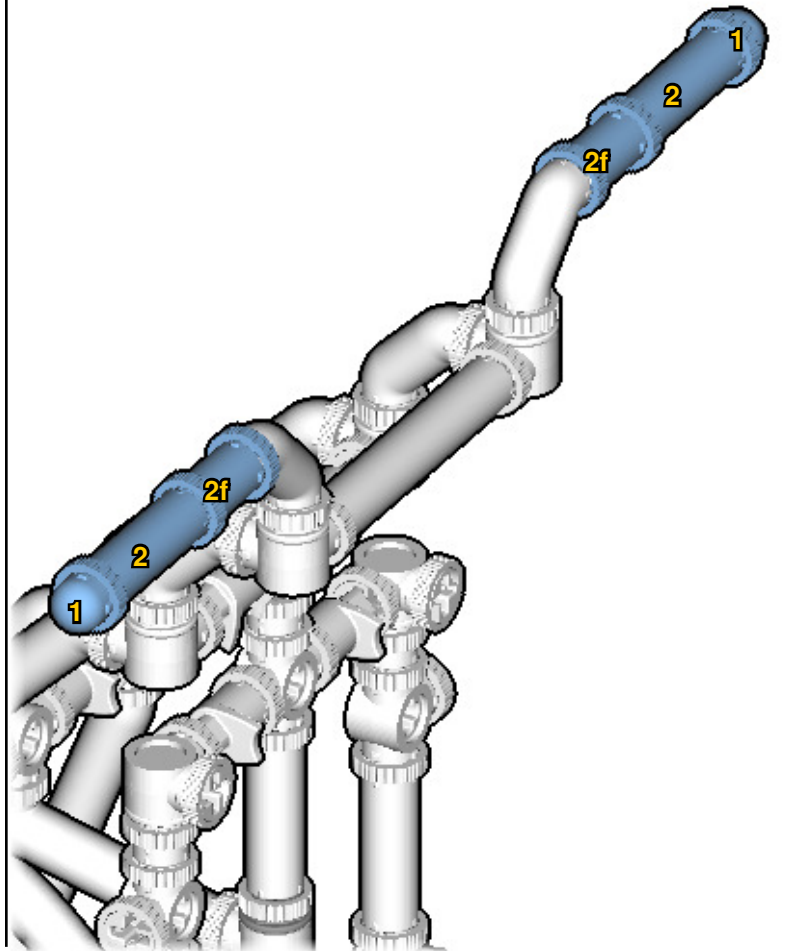

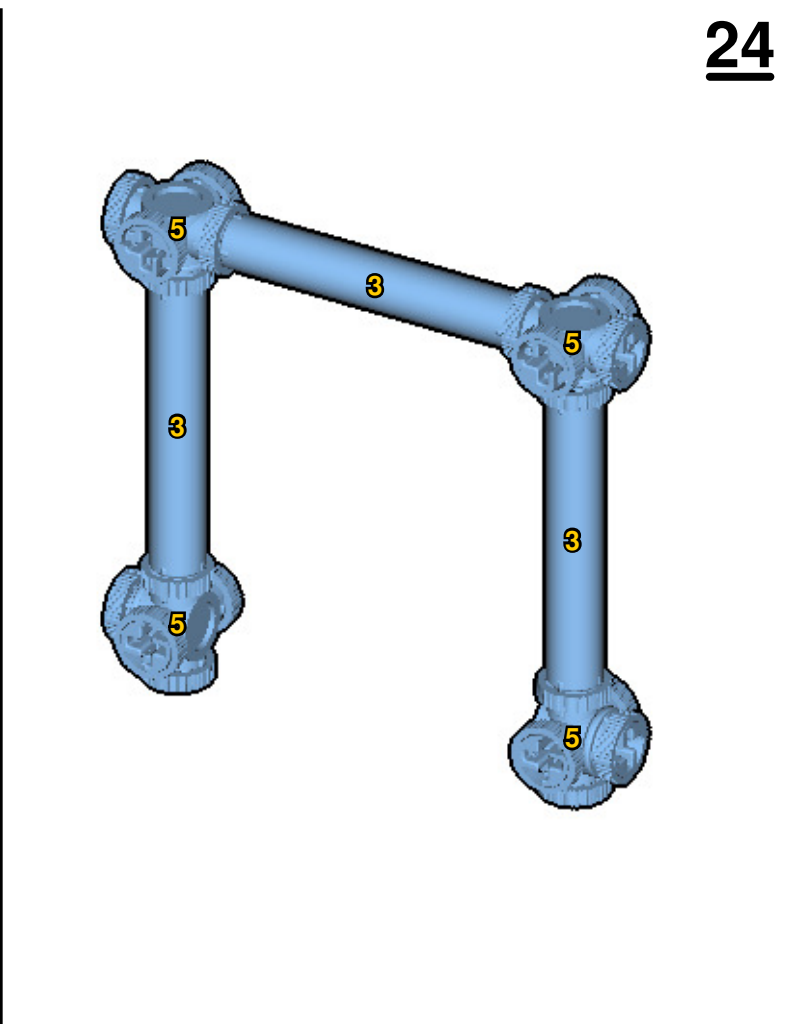
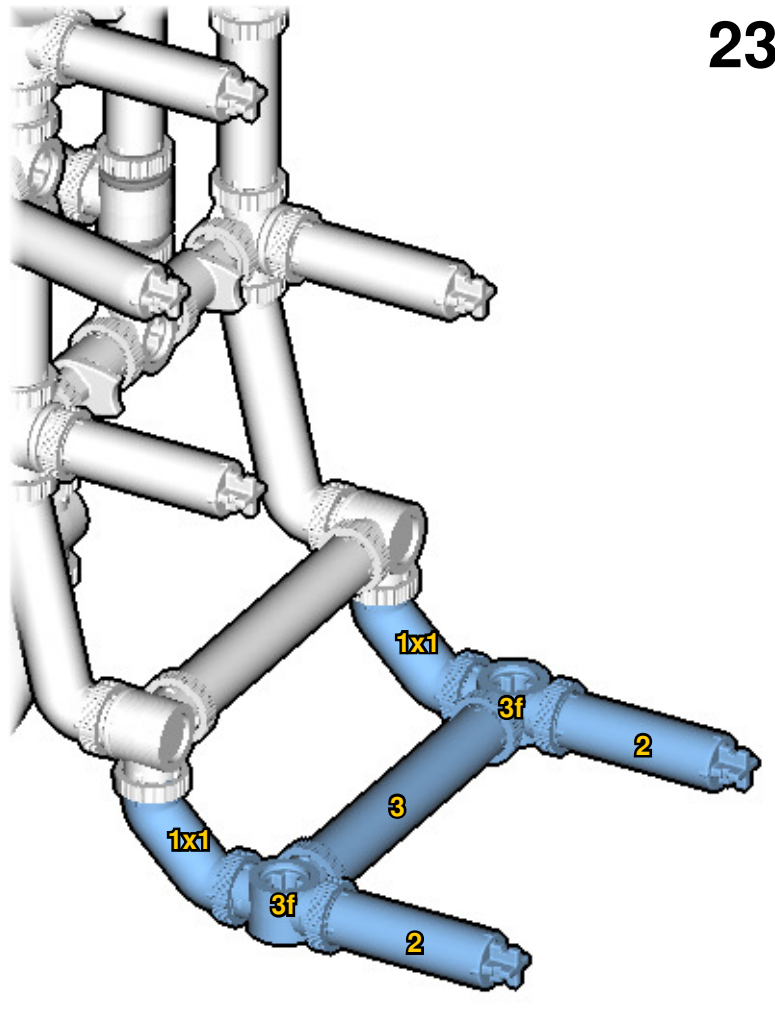
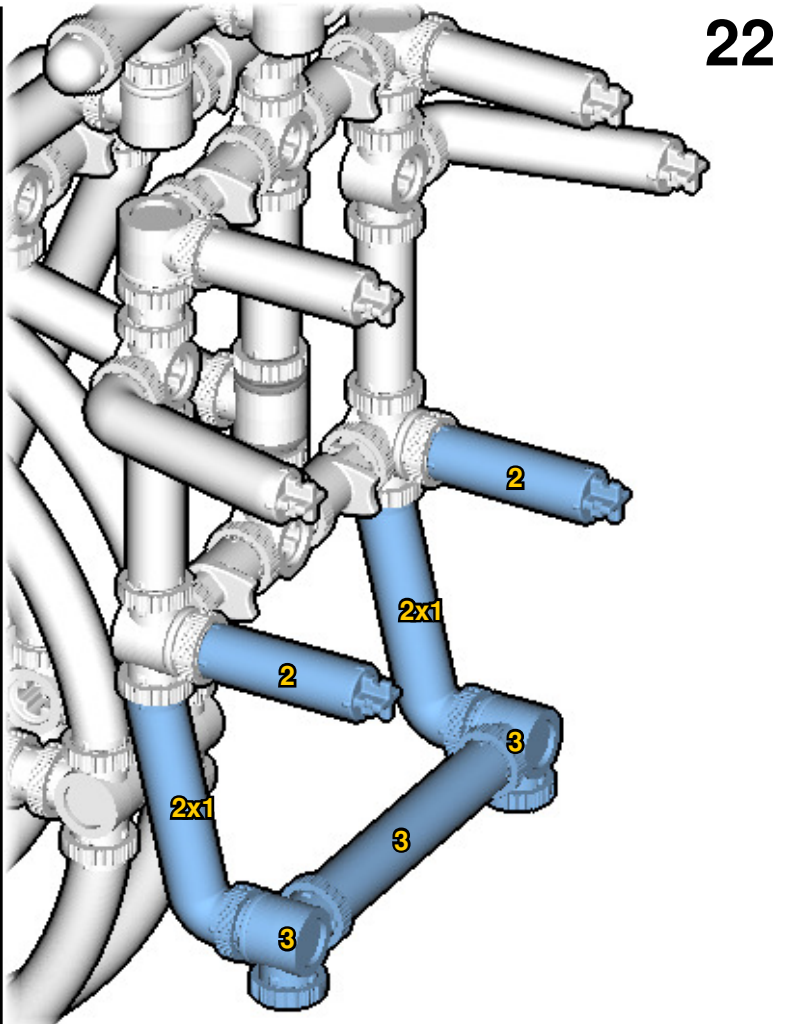
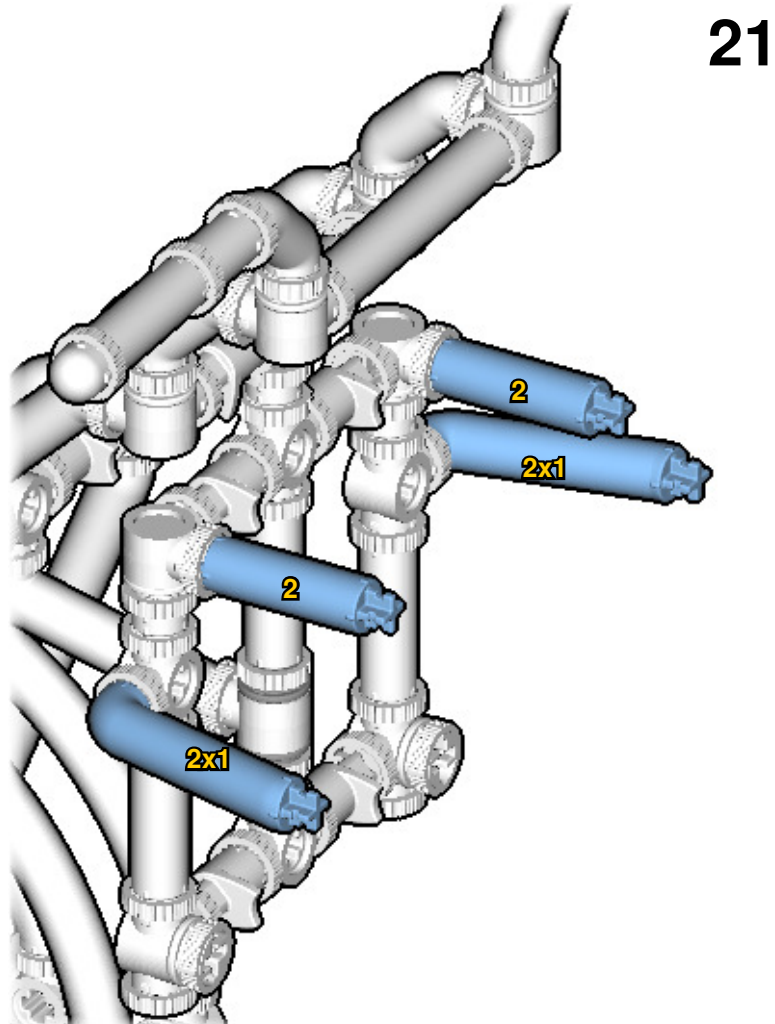



**25**

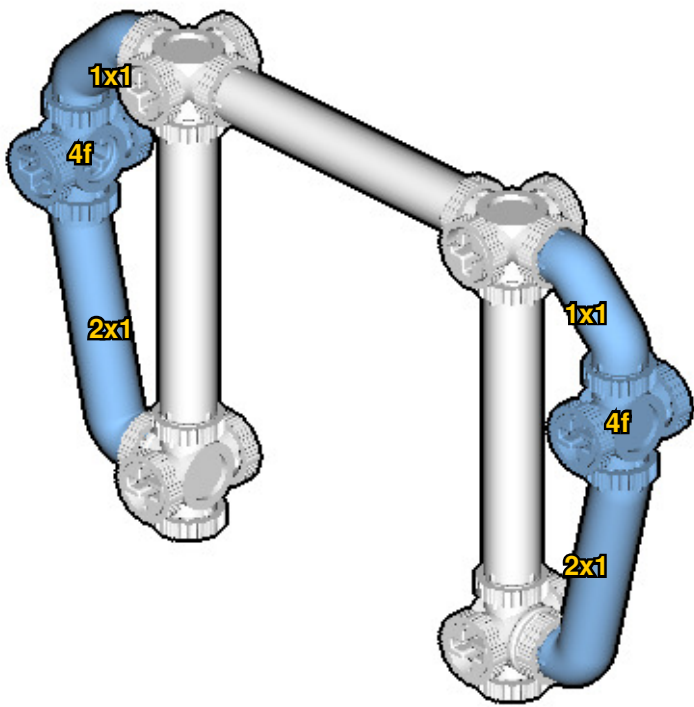

**26**

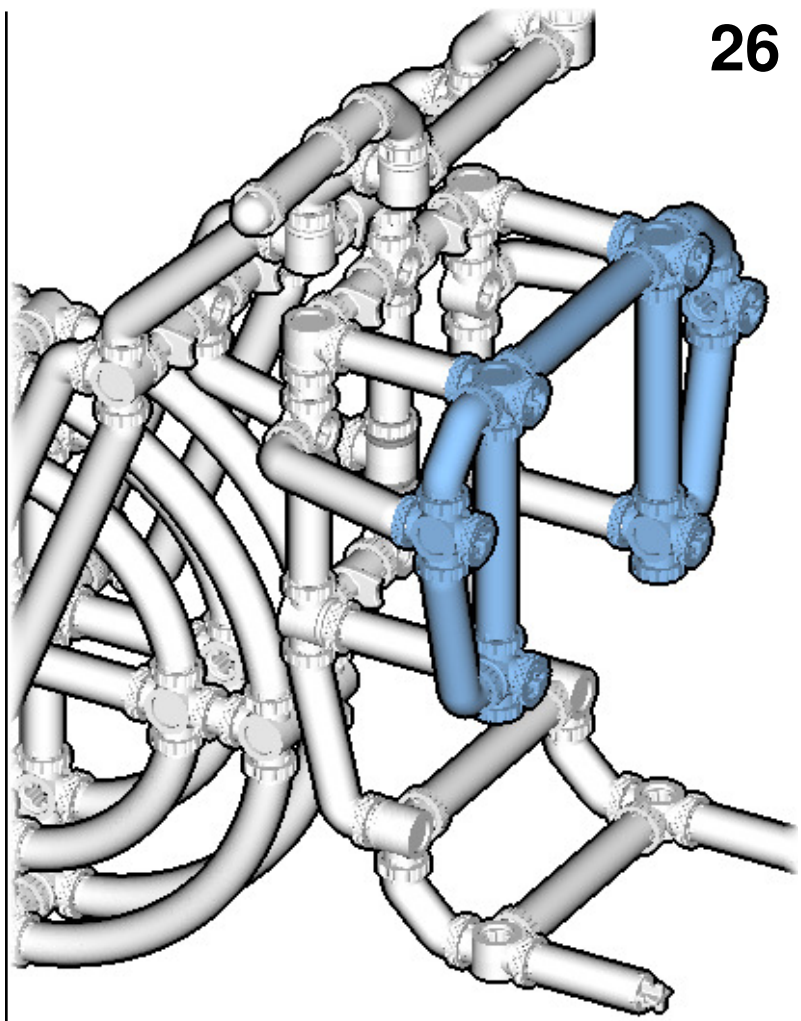

**27**

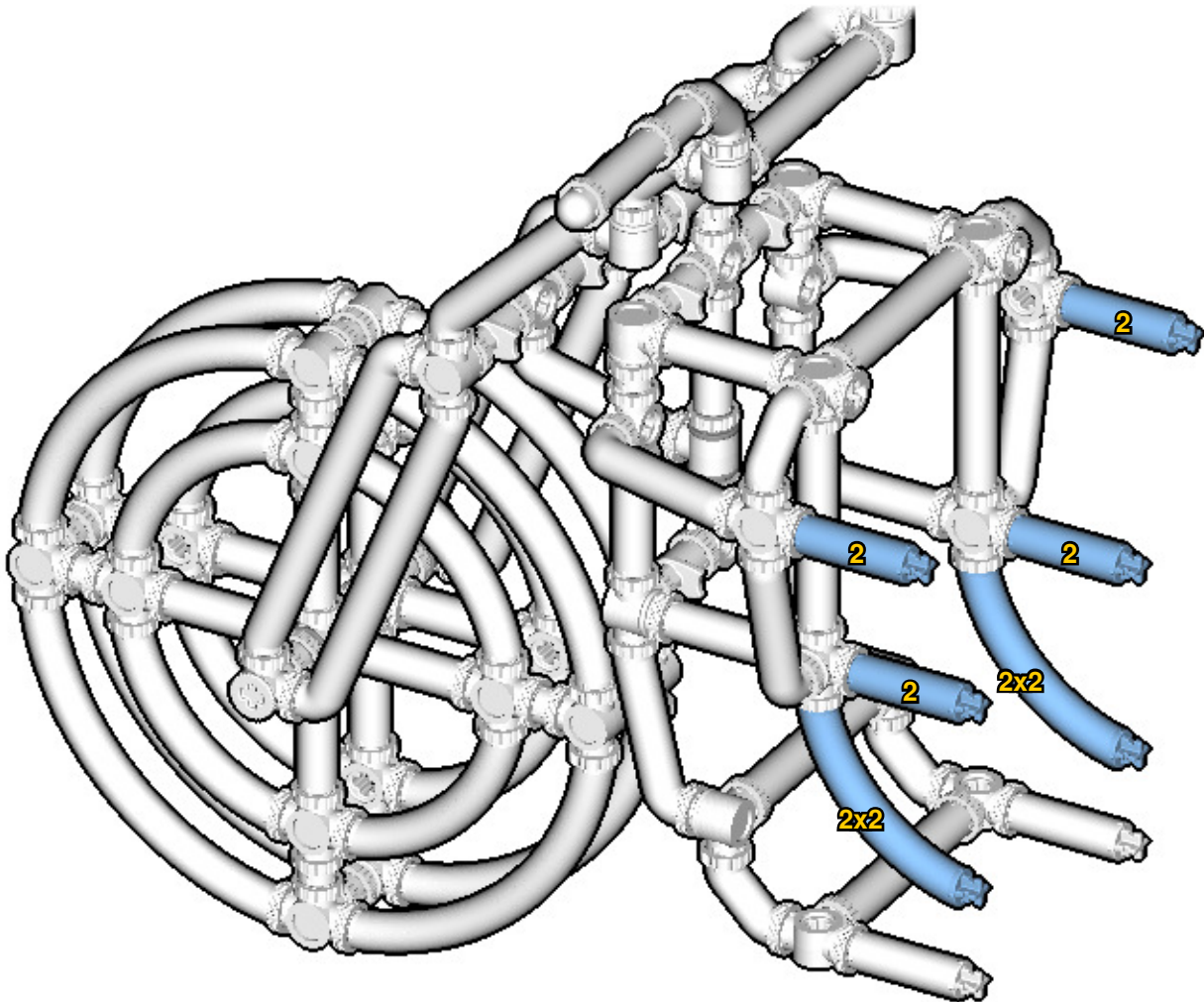

28

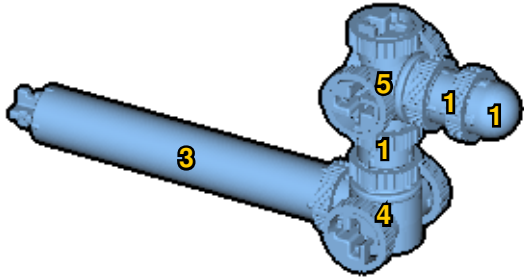

29

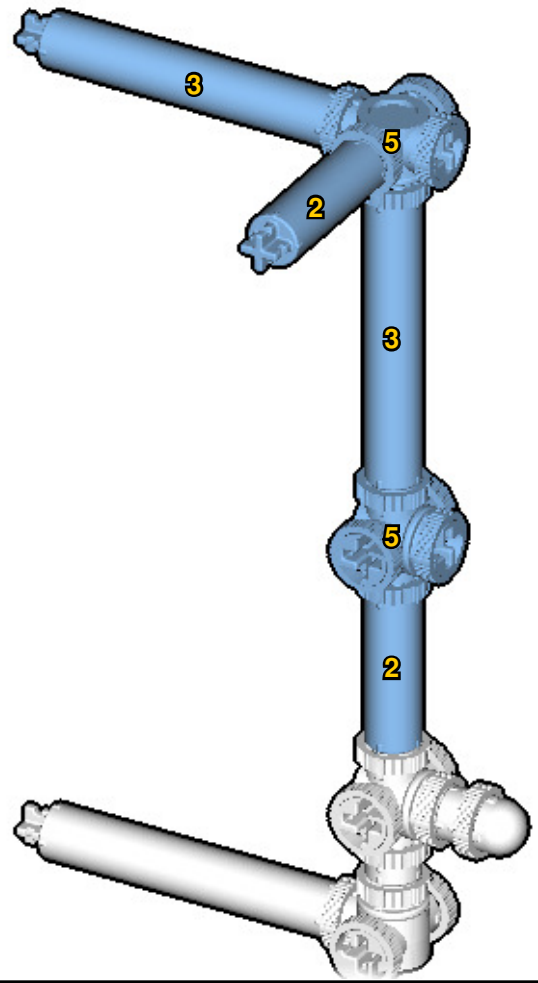

30

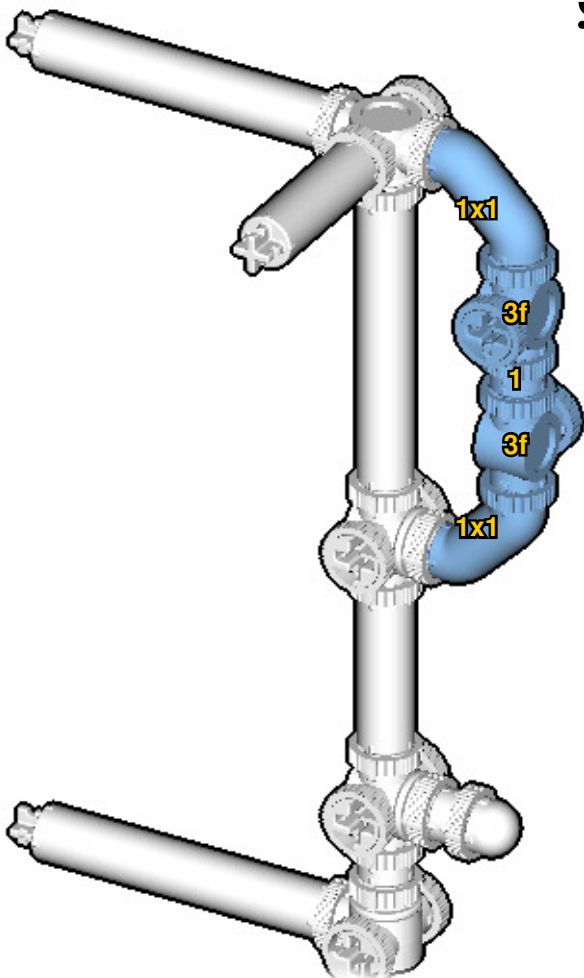

31

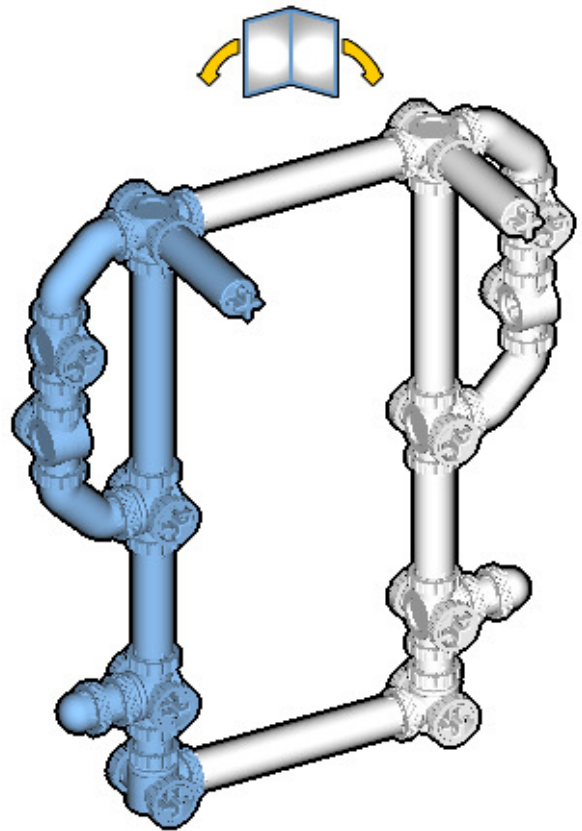

32

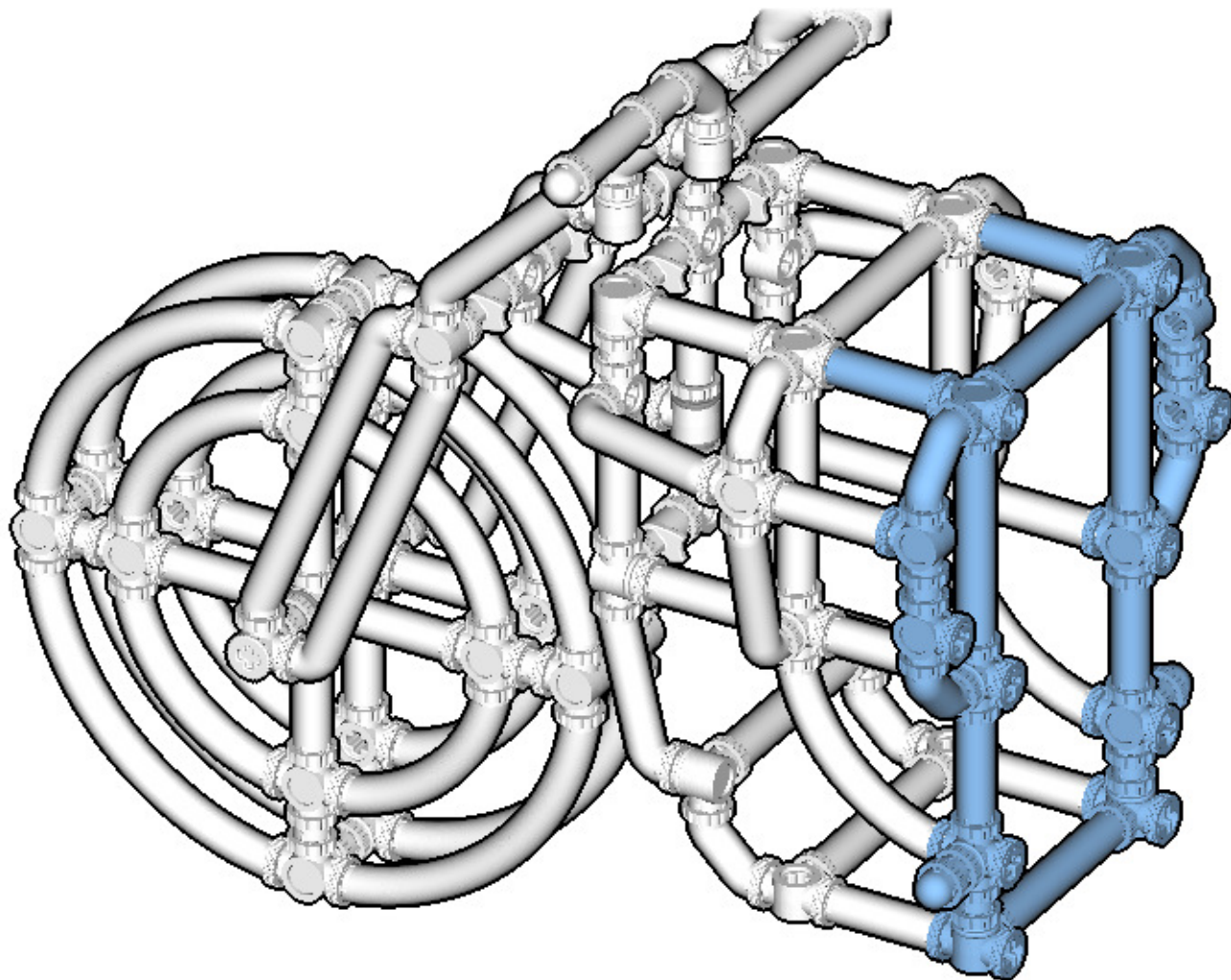

33

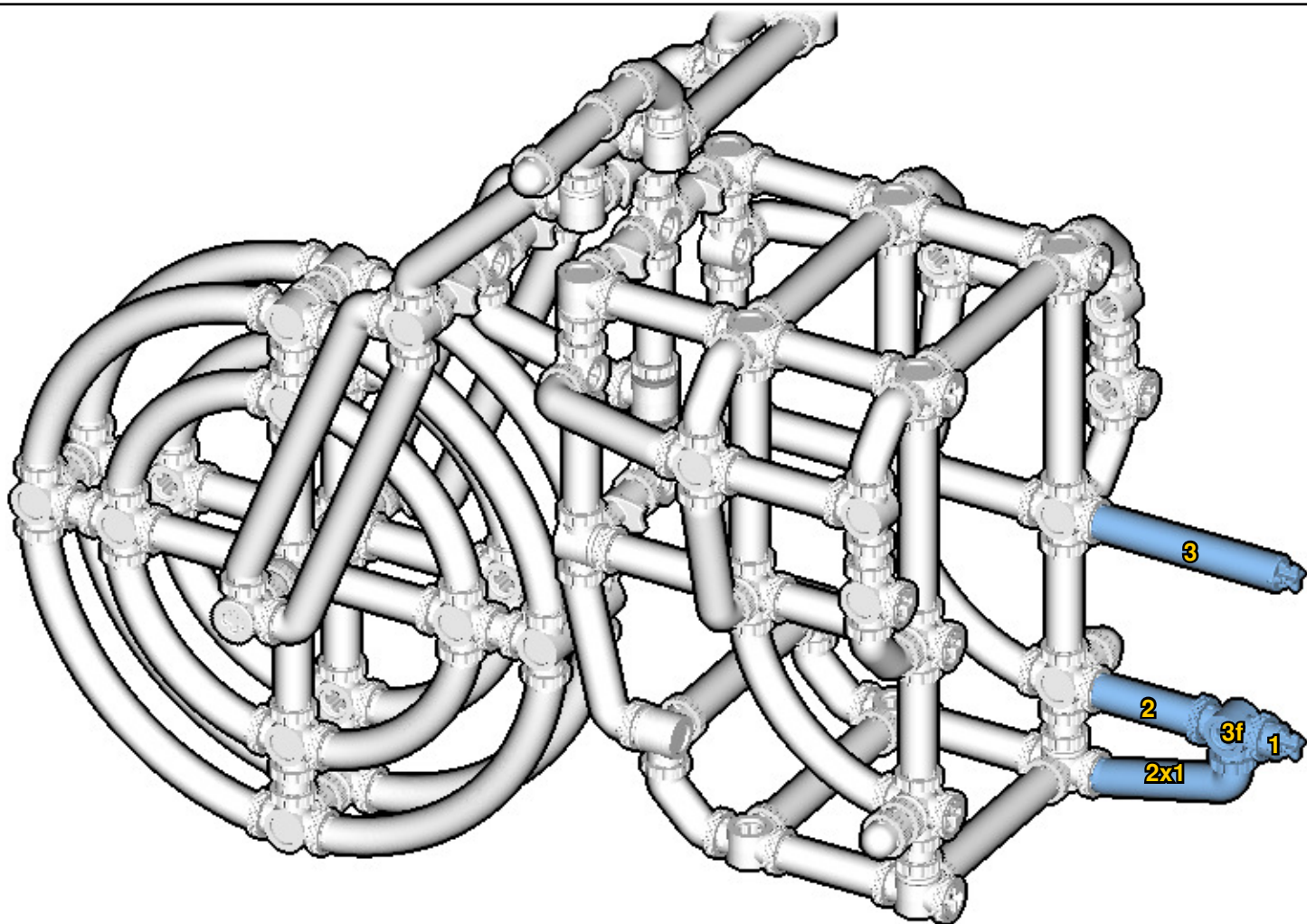

34

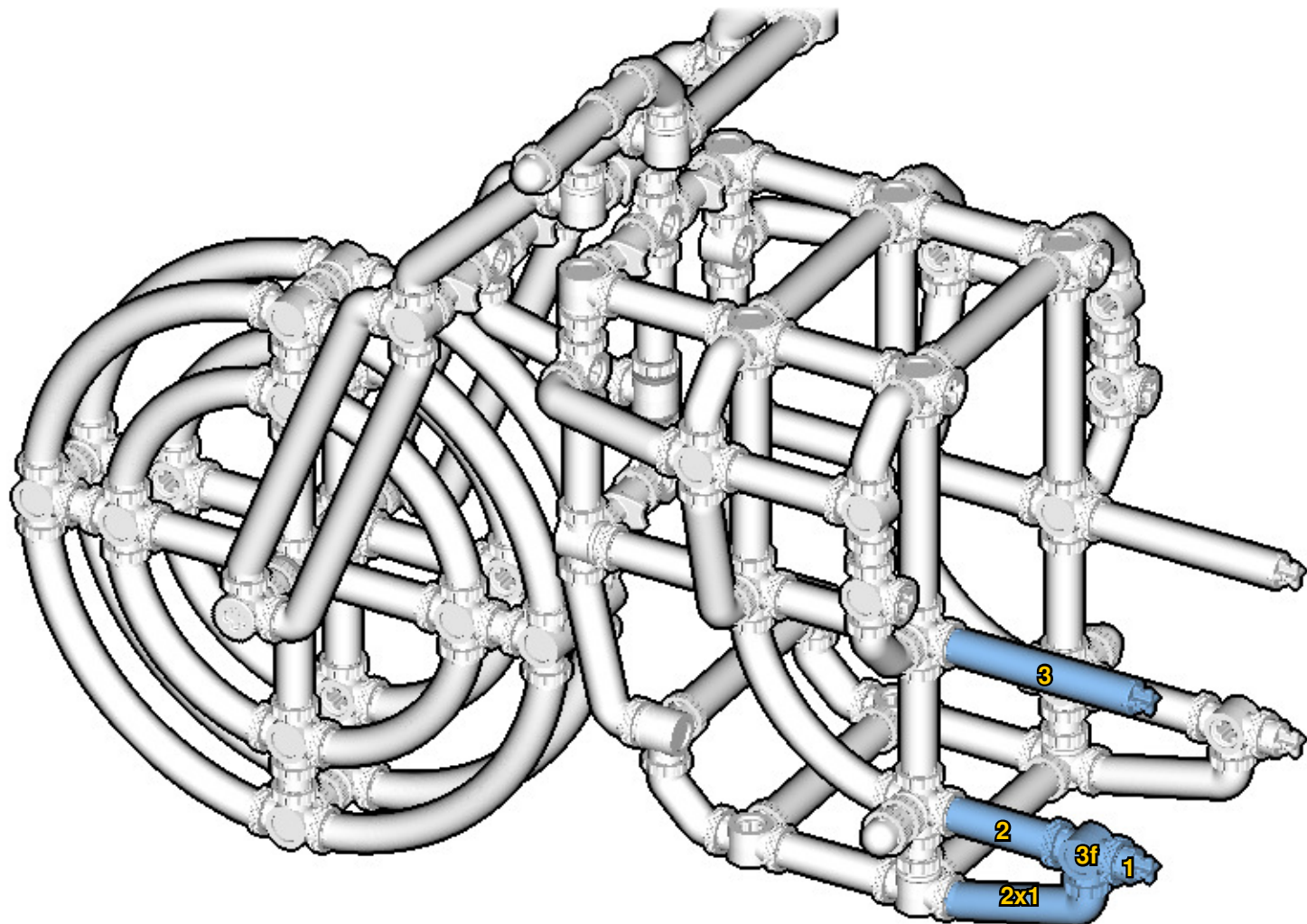

35

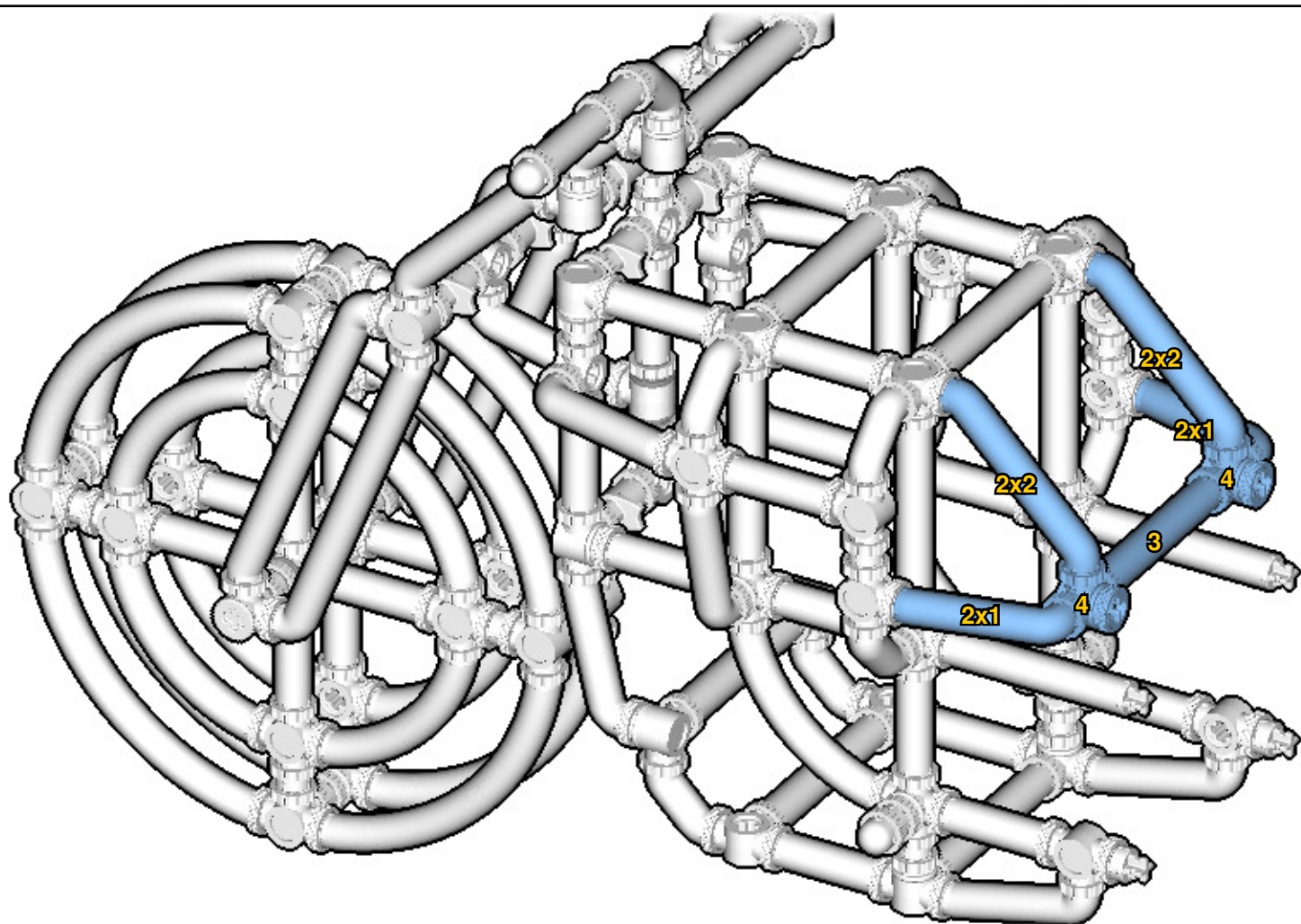

**36**

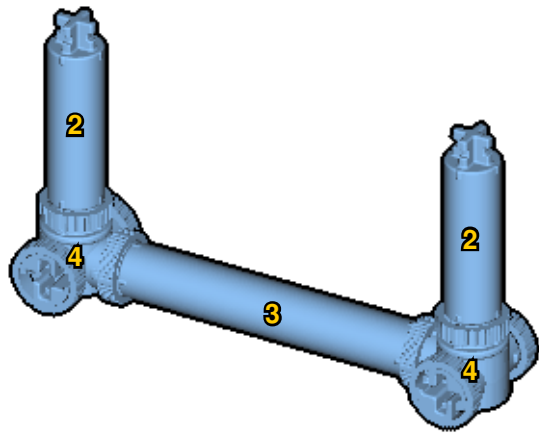

**37**

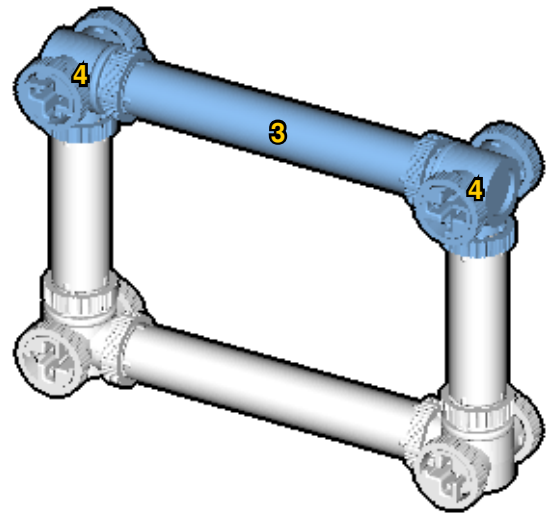

**38**

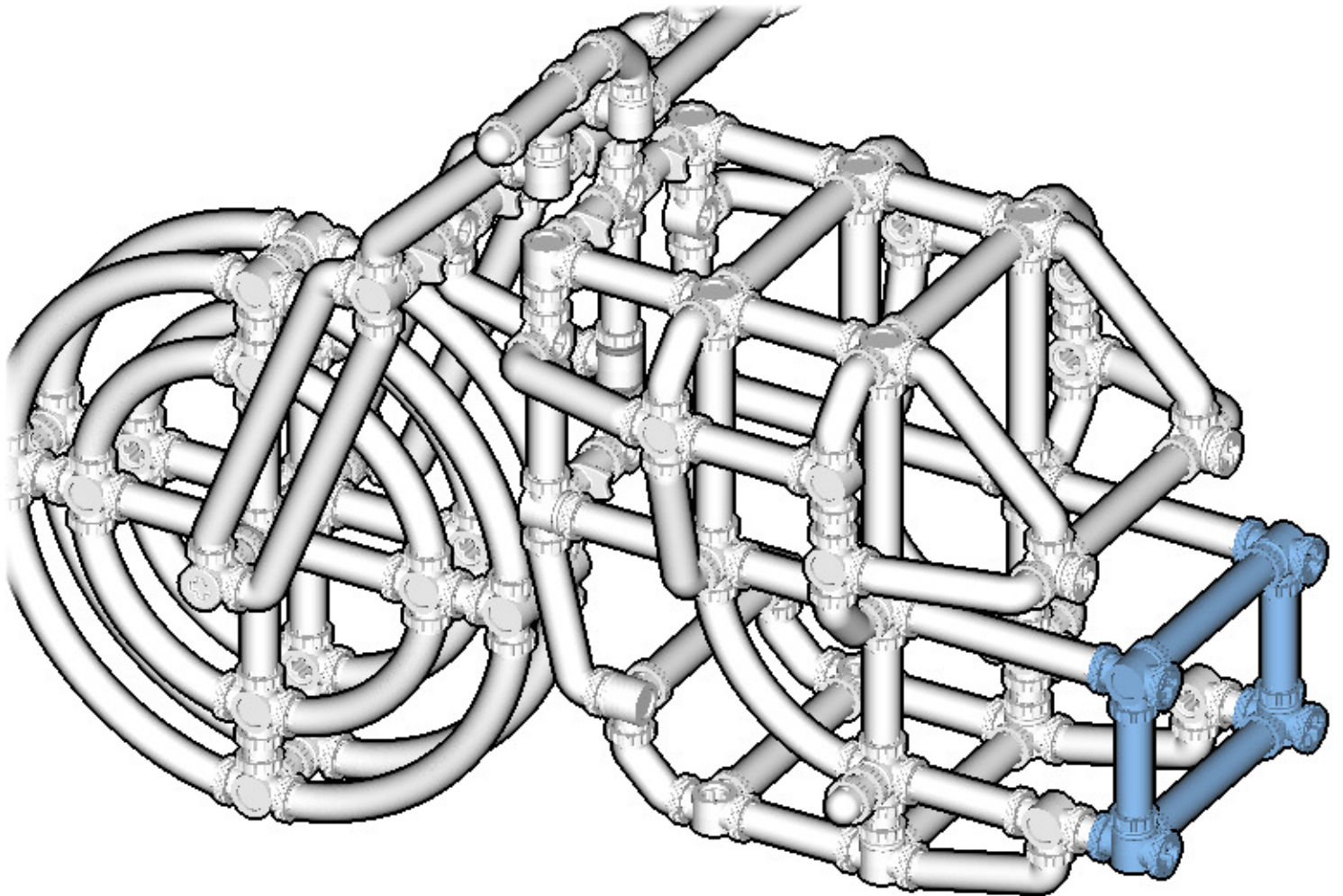

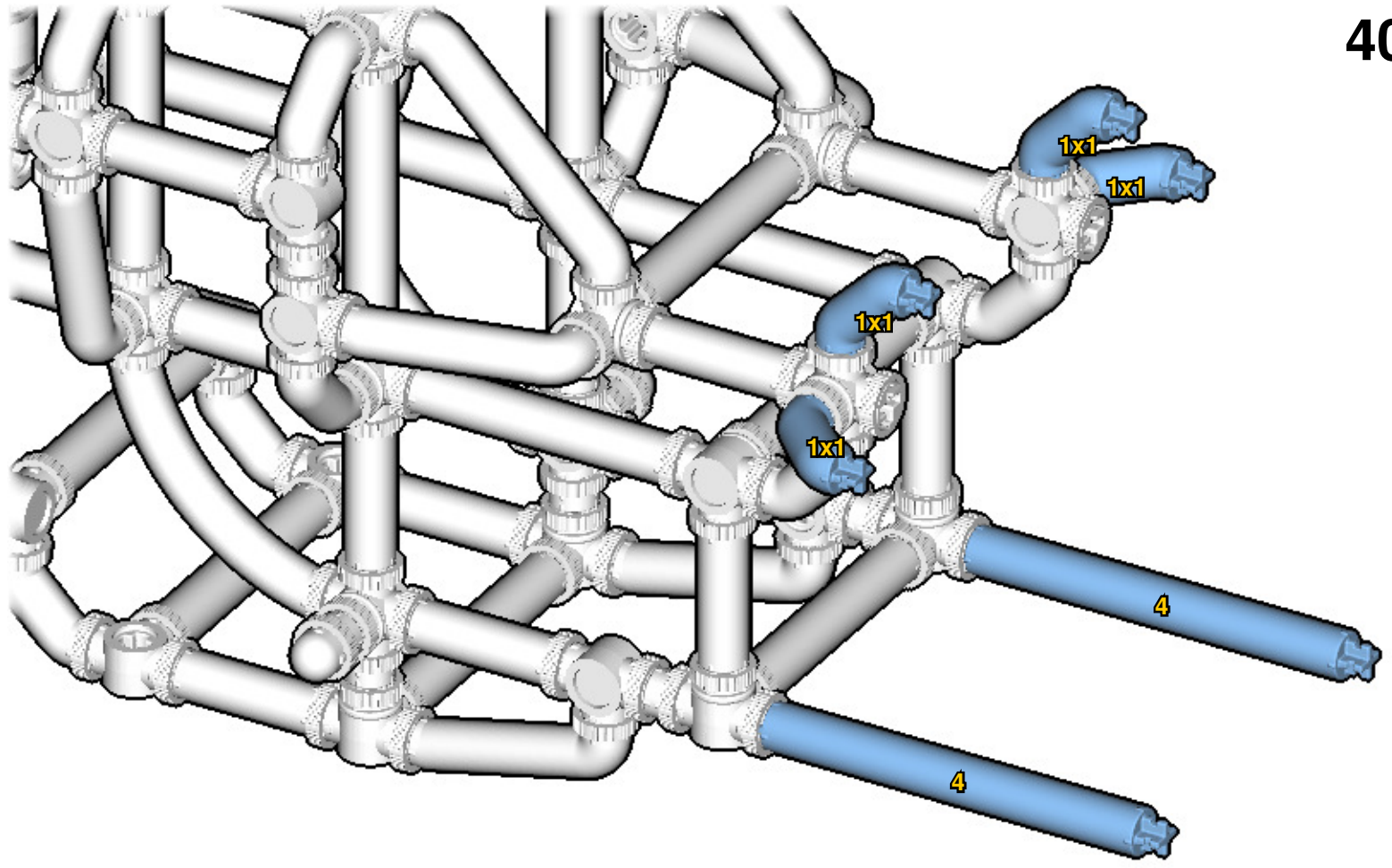
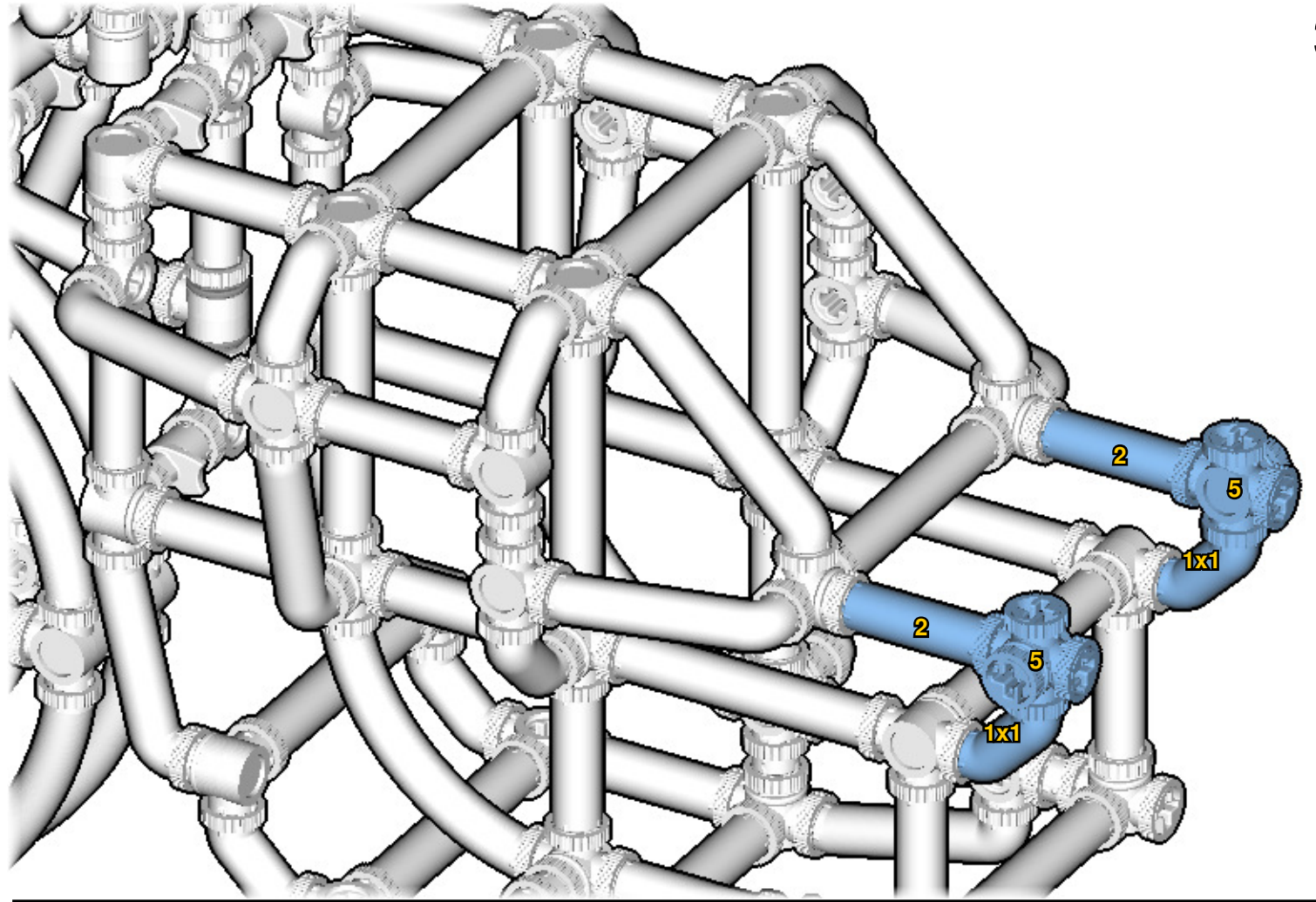

41

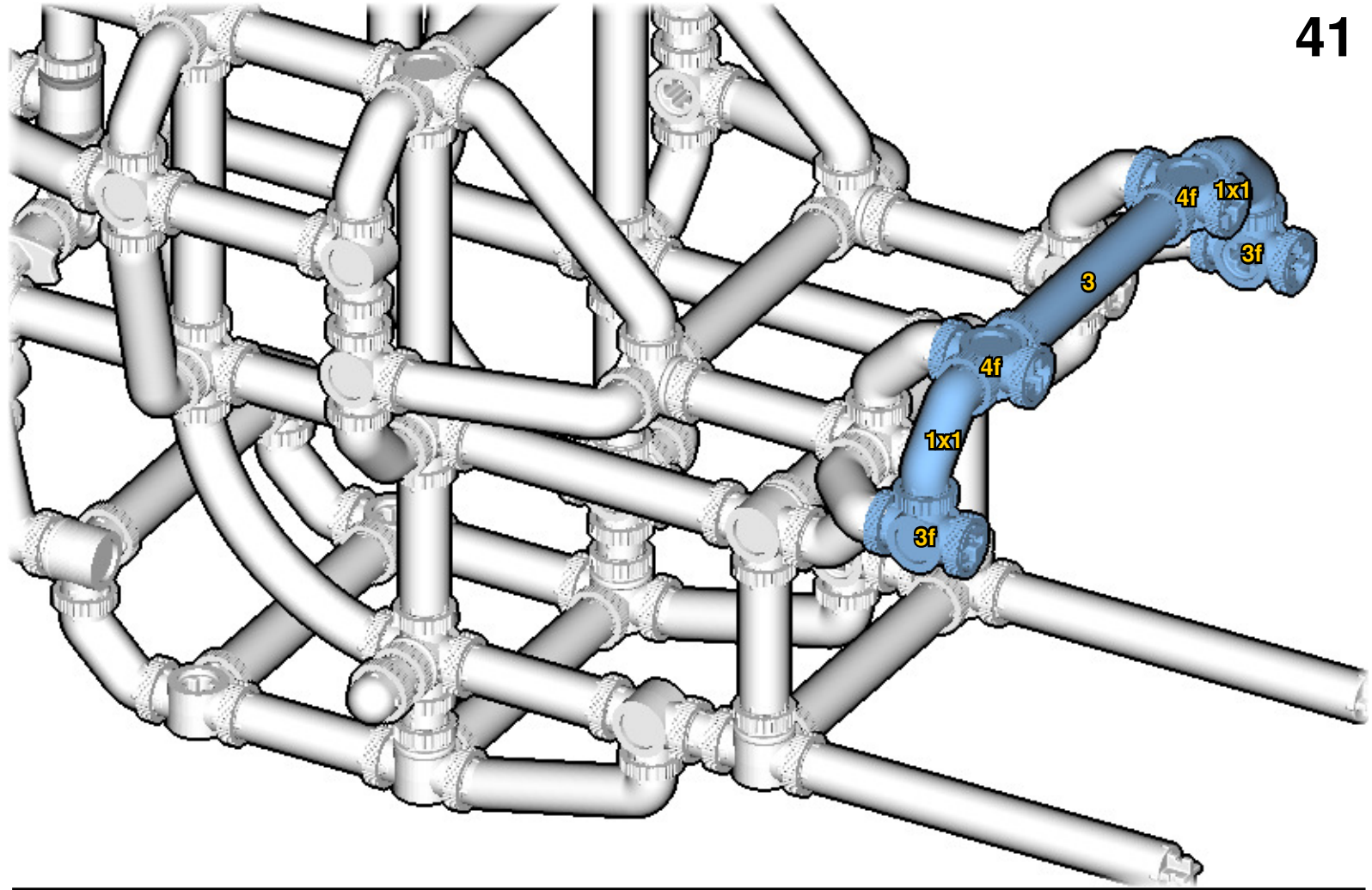

42



43

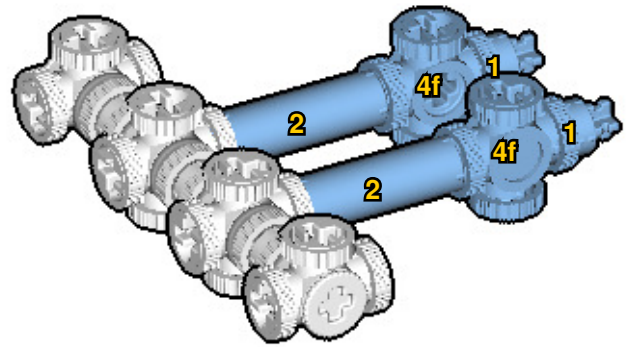

44

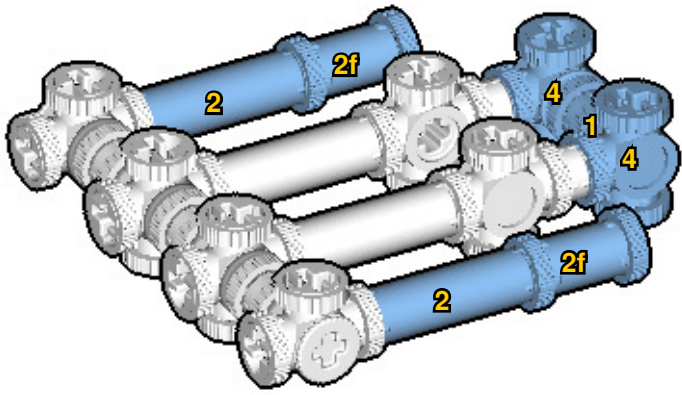

45

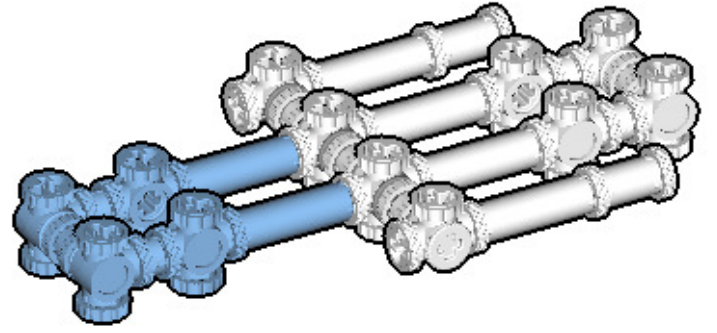
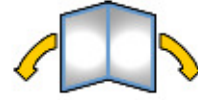

46

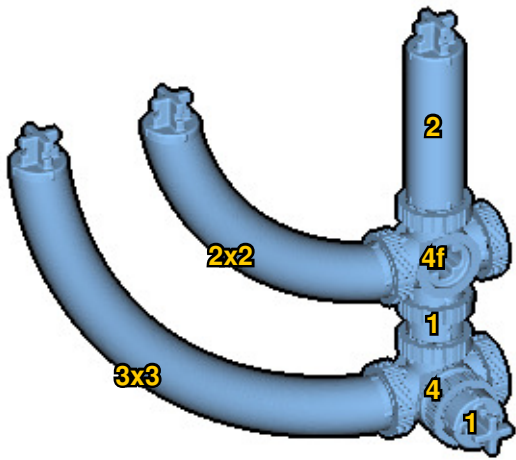

47

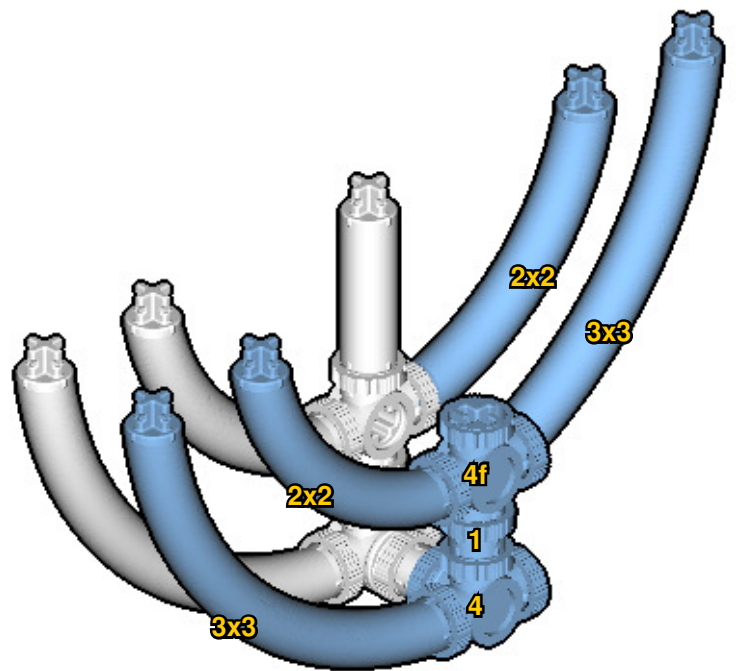



48

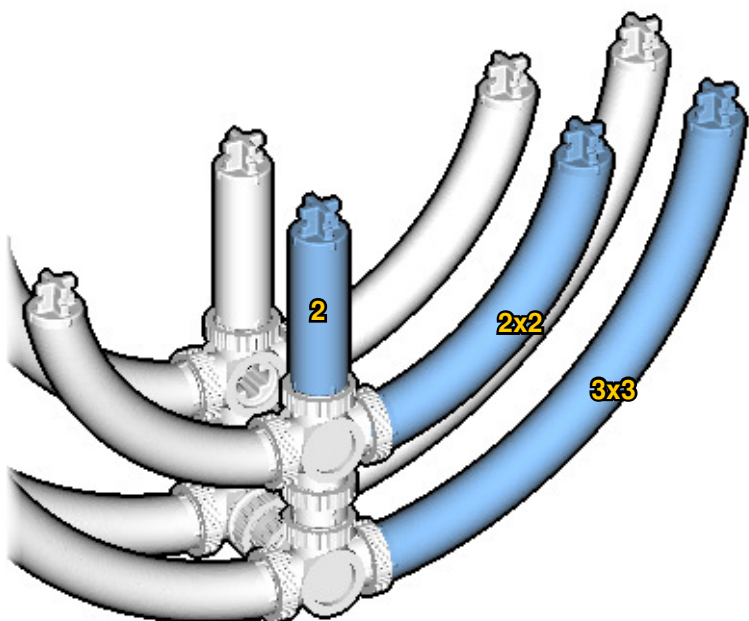

49

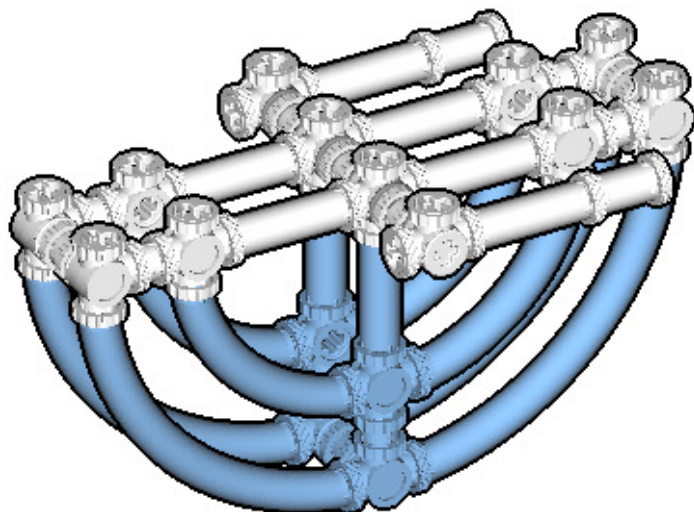

50

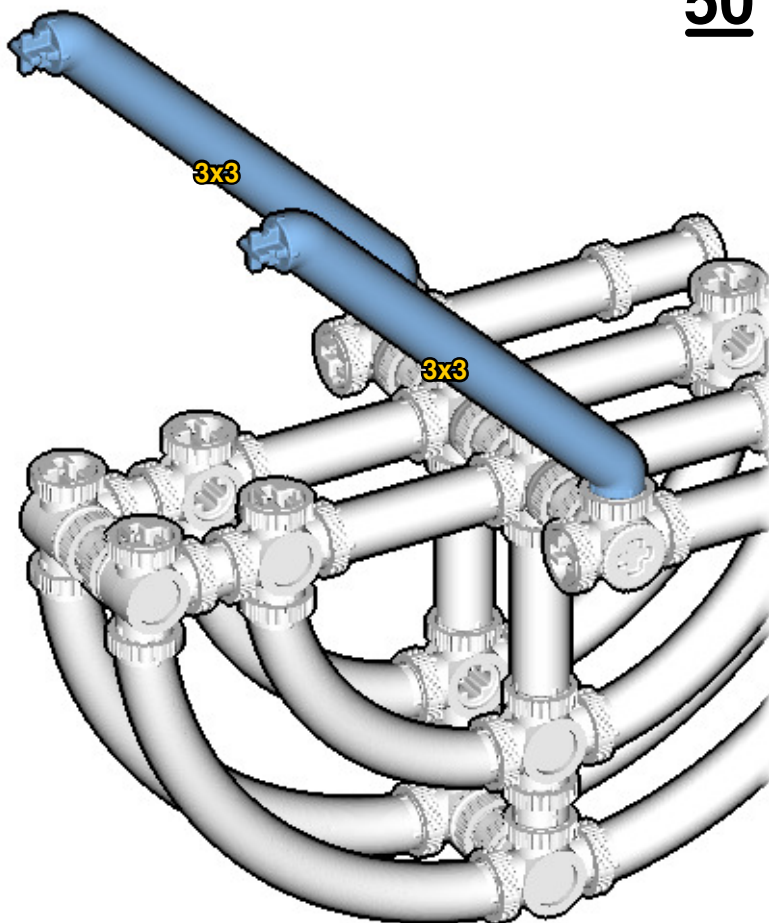

51

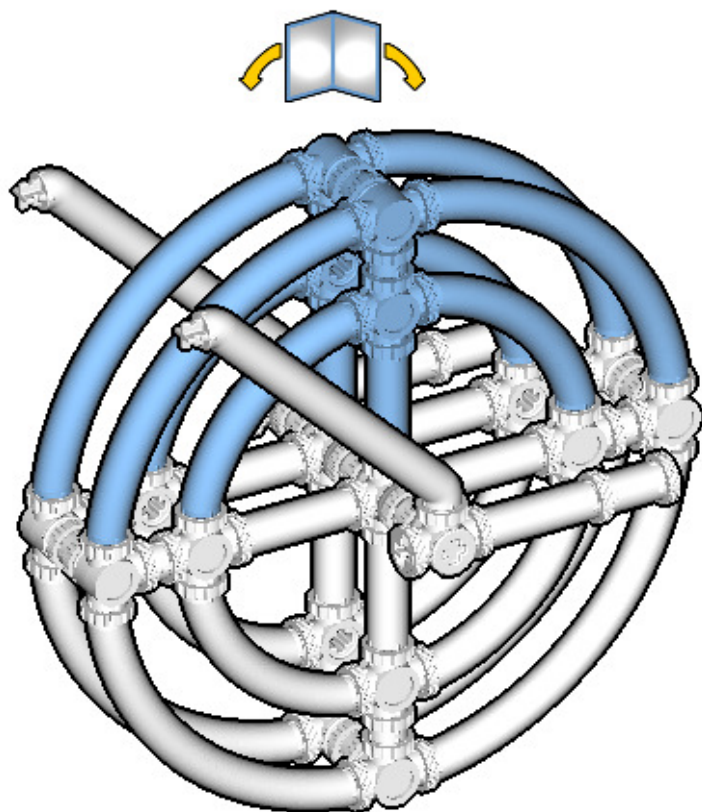

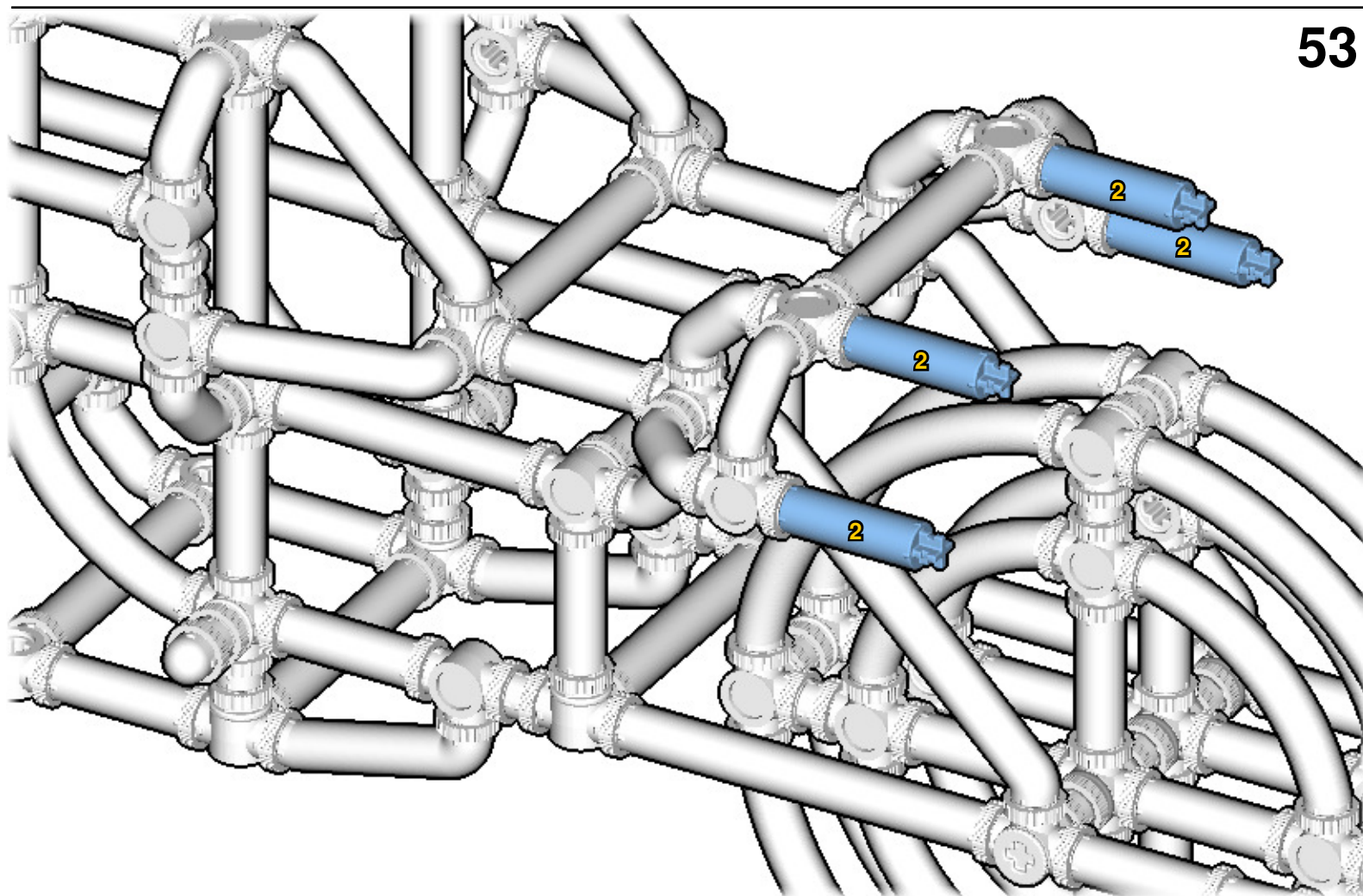
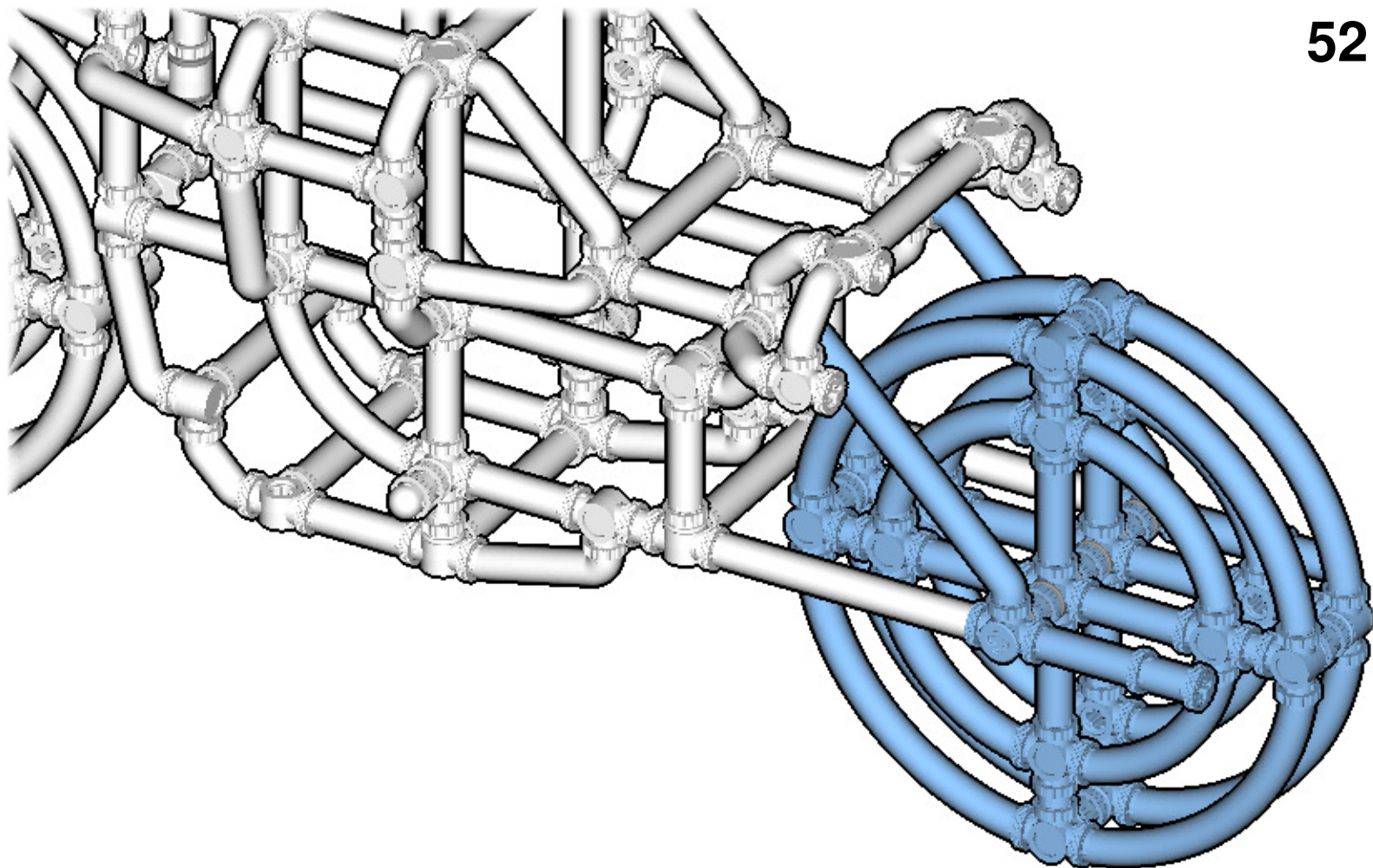

54

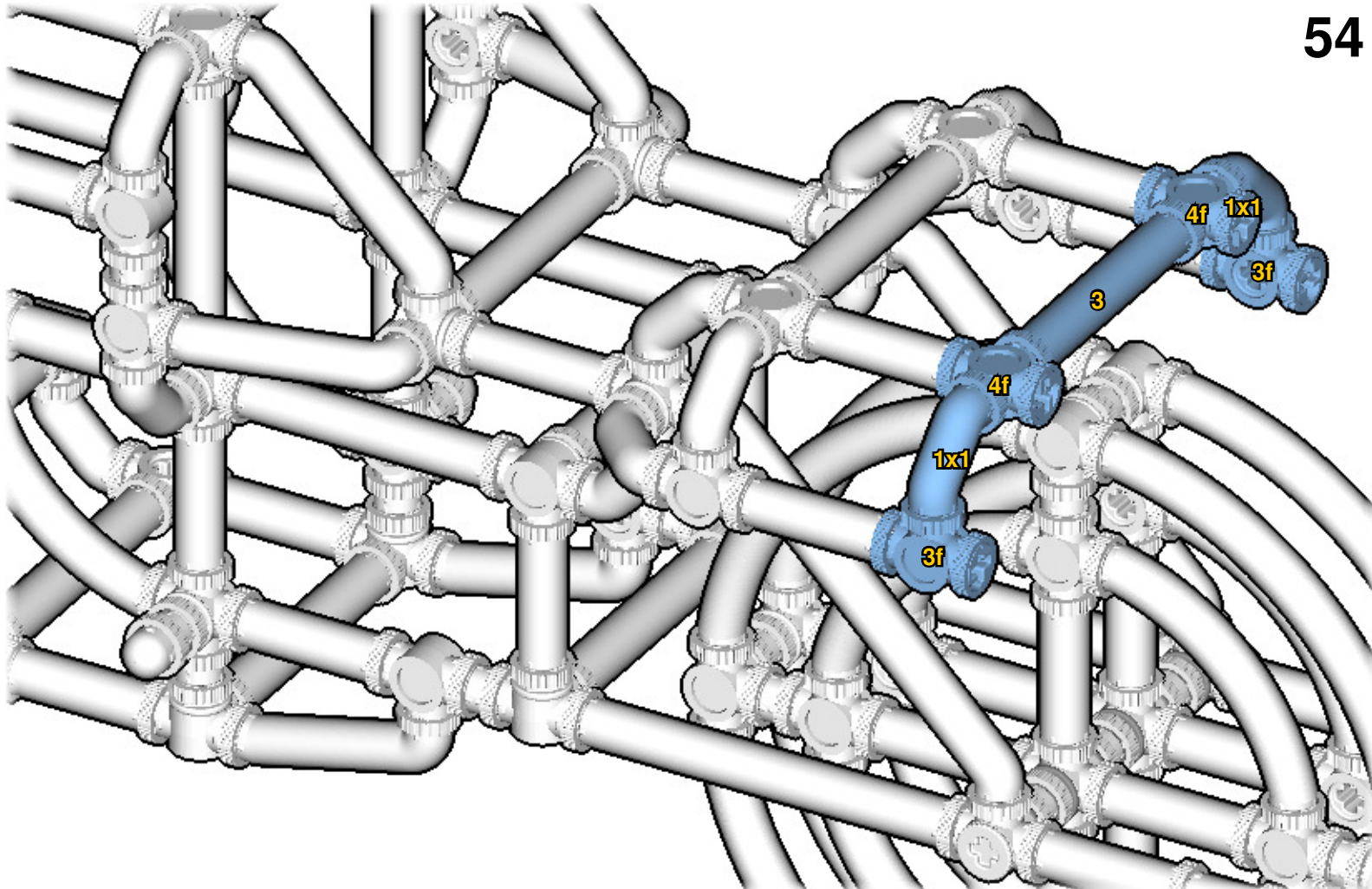

55

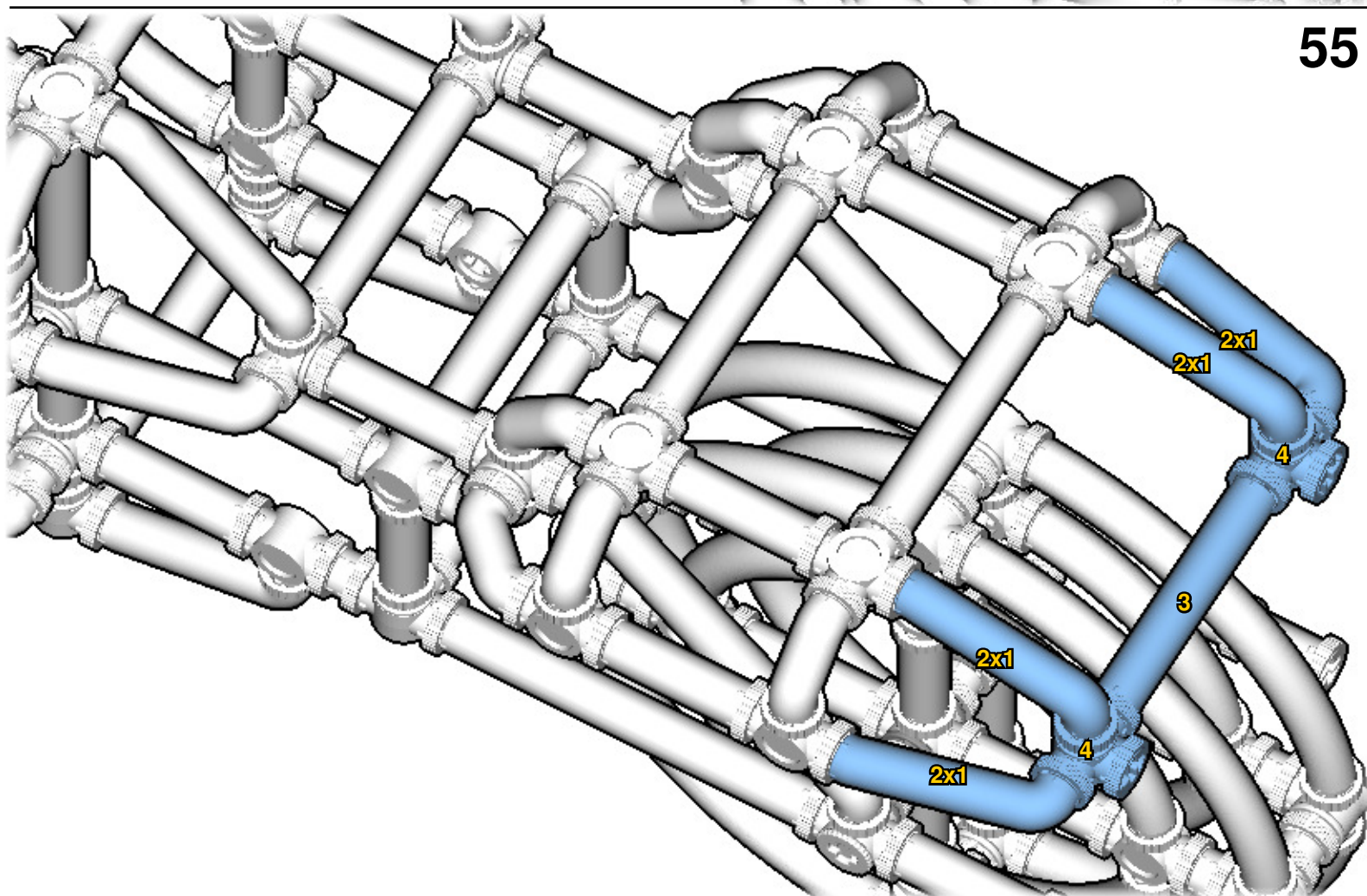

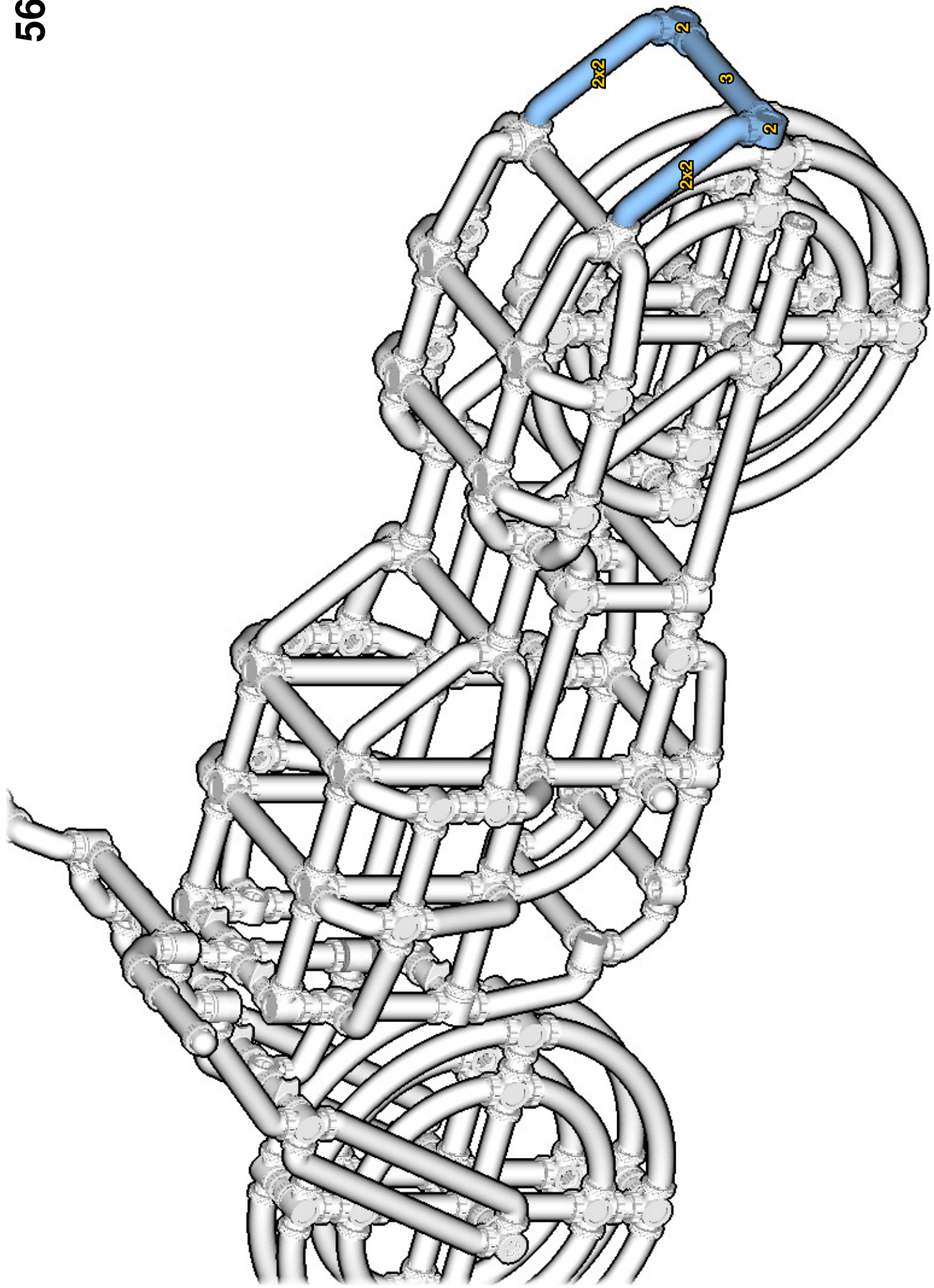

# INVENTORY

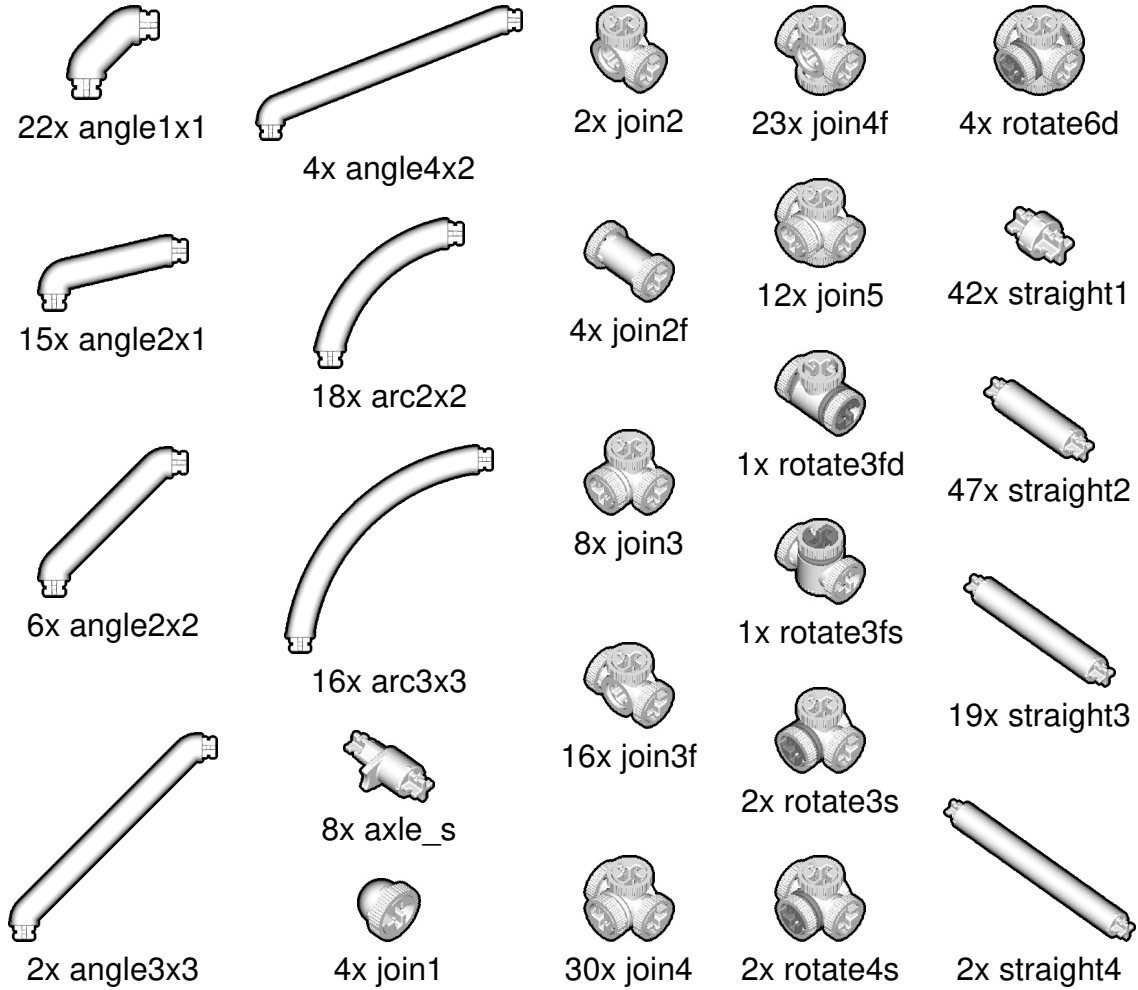

# ACTUAL SIZE

